



K.S.R. COLLEGE OF ENGINEERING

(An Autonomous Institution)

Tiruchengode, Tamil Nadu - 637 215.

1.3.2 Number of value-added courses for imparting transferable and life skills offered during last five years

Academic Year 2021-2022

S.No	Department	Name of the Value Added Courses	No. of times offered During the Same Year	Duration In Hours	No. of Students Completed
1.	Automobile Engineering	Python Programming (Problem Solving)	1	300	4
2.	Civil Engineering	Introduction to CAD - Design, draw, plan, execute and analyze the building	1	30	36
3.	Civil Engineering	Programming Essentials in Python	1	70	20
4.	Computer Science Engineering	Knowledge sharing: Emerging Trends in IT industry	1	35	60
5.	Electrical and ElectronicsEngineering	Printed Circuit Board Design and Fabrication	1	32	24
6.	Electrical and Electronics Engineering	Programmable Logic Controller (PLC)	1	32	24
7.	Electronics and Communication Engineering	IE (I) Sponsored value added course on "Smart Phone Learning and Troubleshooting"	1	30	90
8.	Electronics and Communication Engineering	Hands on Programming Languages in C	1	45	47
9.	Electronics and Communication Engineering	DevelopBrain E-Learning Platform - C Programme	1	30	37
10.	Mechanical Engineering	Programming Essentials in Python	1	150	52
11.	Safety and Fire Engineering	Fire and Safety Training	1	30	18
12.	Information Technology	Cisco NETACAD Python Programming	1	70	55
13.	Information Technology	Learnathon	1	30	35



PRINCIPAL
K.S.R. COLLEGE OF ENGINEERING
K.S.R. KALVI NAGAR,
TIRUCHENGODE-637 215



K.S.R. COLLEGE OF ENGINEERING

(An Autonomous Institution)

Tiruchengode, Tamil Nadu - 637 215.

S.No	Department	Name of the Value Added Courses	No. of times offered During the Same Year	Duration In Hours	No. of Students Completed
14.	Information Technology	Corporate Communication Skills for beginners	1	30	95
15.	Information Technology	Software Manual Testing	1	30	64
16.	Master of Computer Applications	Python Programming basics to Advanced	1	32	33
17.	KSRCE Training and Placement Cell	Accenture Specific Training, (R Sequence) CIVIL, CSE, ECE, EEE, JT, MECH(Third Year)	1	140	75
18.	KSRCE Training and Placement Cell	Technical, Aptitude and Soft Skills (Internal) AUTO, CIVIL, CSE, ECE, EEE, IT, MECH (Second Year Students)	1	70	75
19.	KSRCE Training and Placement Cell	Wipro Specific Training (New Leaf, Chennai) AUTO, CIVIL, CSE, ECE, EEE, IT, MECH (Final Year Students)	1	35	116
20.	KSRCE Training and Placement Cell	Aptitude Training (Internal) MBA,MCA (Final Year Students)	1	55	46
21.	KSRCE Training and Placement Cell	TCS NINJA Specific Training (Top Fresher's) CSE,ECE,EEE,IT(UG Final Year Students)	1	30	73
22.	KSRCE Training and Placement Cell	Capgemini Specific Training (Top Fresher's) CSE,ECE,EEE,IT,MCA(PG,UG Final Year Students)	1	35	120
23.	KSRCE Training and Placement Cell	Technical Training (Internal) CSE,ECE,EEE,IT (Third Year Students)	1	35	221
24.	KSRCE Training and Placement Cell	Soft Skills Training (Internal) AUTO, CIVIL, MECH (Third Year Students)	1	35	133
25.	KSRCE Training and Placement Cell	Aptitude Training (Internal) CSE (Third Year Students)	1	35	49
26.	KSRCE Training and Placement Cell	Aptitude Training (Internal) MBA (Final Year Students)	1	40	21
27.	KSRCE Training and Placement Cell	Aptitude Training (Internal) CSE (Third Year Students)	1	40	54
28.	KSRCE Training and Placement Cell	Aptitude Training (Internal) ECE, EEE (Third Year Students)	1	40	45



PRINCIPAL
K.S.R. COLLEGE OF ENGINEERING
K.S.R. KALVI NAGAR,
TIRUCHENGODE-637 215.



K.S.R. COLLEGE OF ENGINEERING

(An Autonomous Institution)

Tiruchengode, Tamil Nadu - 637 215.

S.No	Department	Name of the Value Added Courses	No. of times offered During the Same Year	Duration In Hours	No. of Students Completed
29.	KSRCE Training and Placement Cell	Soft Skills Training(Internal) ECE, EEE (Third Year Students)	1	35	48
30.	KSRCE Training and Placement Cell	Aptitude Training (Internal) ECE, EEE (Third Year Students)	1	40	48
31.	KSRCE Training and Placement Cell	Soft Skills Training(Internal) ECE, EEE (Third Year Students)	1	35	45
32.	KSRCE Training and Placement Cell	Aptitude Training (Internal) AUTO,CIVIL,MECH(Third Year Students)	1	40	143
33.	KSRCE Training and Placement Cell	Soft Skills Training(Internal) IT (Second Year Students)	1	40	60
34.	KSRCE Training and Placement Cell	Aptitude Training & Technical Training (Auto, EEE, IT, ECE)	1	130	231
35.	KSRCE Training and Placement Cell	IT Specific Training(Top Fresher's) AUTO,CSE,ECE,EEE,IT,MECH (Pre Final Year Students)	1	80	266
36.	KSRCE Training and Placement Cell	Technical Training(Internal) CSE,EEE,IT(Second Year Students)	1	40	267
37.	KSRCE Training and Placement Cell	IT Specific Training(Top Fresher's) AUTO,CSE,ECE,EEE,IT,MECH & MCA(Pre Final Year Students)	1	100	314
38.	KSRCE Training and Placement Cell	IT Specific Training(Top Fresher's) MCA	1	100	55
39.	KSRCE Training and Placement Cell	Aptitude & Soft skills Training(Top Fresher's) AUTO,CIVIL,CSE,ECE,EEE,IT,MECH,SFE (Second Year)	1	40	508
Total number of Value Added Courses offered in the Academic Year 2021 -2022		39	Total Number of Students Completed Value Added Courses		3707



PRINCIPAL
K.S.R. COLLEGE OF ENGINEERING
K.S.R. KALVI NAGAR,
TIRUCHENGODE-637,215

PRINCIPAL

K.S.R. COLLEGE OF ENGINEERING (Autonomous)
(An Autonomous Institution, approved by AICTE, Accredited by NAAC with A grade
& Affiliated to Anna University)

**K.S.R. Kalvi Nagar, Tiruchengode – 637 215,
Namakkal District, Tamil Nadu**

Phone: 04288-274213

Fax: 04288-274757

E - mail: principal@ksrce.ac.in

Department of AUTOMOBILE ENGINEERING

Phone : 9894402958 (HoD)

e - mail:ksrceauto@gmail.com

Date: 19.07.2021

Submitted to Principal:

Sub.: Permission for conducting Value Added Course on “Python Programming”- Reg.

Respected sir,

Our department conducted for First Year B.E Automobile students on the topic of “Python Programming” from 03.07.2017(Monday) to 29.12.2017(Friday), Time 9.30 AM to 12.30 PM at KSRCE IT LAB. Hence, we request to give me permission for the same.

Thanking You,

I. Ms.Mousumi,
Traineer,
ICT Academy

I. Ms.Suganya
Assistant Professor – CSE

Copy to:
Association file & HoD file

Course Co-ordinator

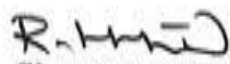
Signature of HOD

Principal



PRINCIPAL,
K.S.R. COLLEGE OF ENGINEERING
K.S.R. KALVI NAGAR,
TIRUCHENGODE-637 215

K.S.R. COLLEGE OF ENGINEERING (Autonomous)
(An Autonomous Institution, approved by AICTE, Accredited by NAAC with A grade
& Affiliated to Anna University)

K.S.R. Kalvi Nagar, Tiruchengode – 637 215,
Namakkal District, Tamil Nadu

Phone: 04288-274213

Fax: 04288-274757

E - mail: principal@ksrce.ac.in

Department of Automobile Engineering

Phone :9894402958(HoD)

e - mail:ksrceauto@gmail.com

Date: 19-07-2021

**Value added Course
On
"Python Programming"**

S.No.	Resource Person	Course Content
1	I.Ms.Mousumi, Trainer, ICT Academy.	<ul style="list-style-type: none"> • Basics of Python • Developer tools and the runtime environment • Fundamentals of object –oriented programming • Resolve implementation problems

Course Outcome

Through this course students will be able to:

- Analyze technical drawings using Python tools.
- They know about fundamental programming techniques, best problem solving practices, including the most common library function in python 3

By the end of this course, each student should be able to:

- Utilize python 3 software to solve technical problems.
- Apply the syntax and semantics of the python language.

COURSE CO-ORDINATOR



R. [Signature]
HoD

PRINCIPAL

PRINCIPAL,
K.S.R. COLLEGE OF ENGINEERING
TIRUCHENGODE - 637 209

K.S.R COLLEGE OF ENGINEERING (AUTONOMOUS), TIRUCHENGODE – 637215

DEPARTMENT OF AUTOMOBILE ENGINEERING

A VALUE ADDED COURSE ON “Product Design & Manufacturing”

Date: 05.09.2021

ISSUE CERTIFICATE

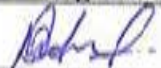
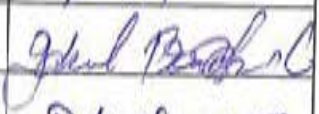
S. No.	Register. No	Name of the Student	Year	Signature
1	1911023	SUGUMAR D	III	
2	1911006	GOKUL PRANESH C	III	
3	1911001	BALACHANDAR A	III	Balachander. A
4	1911015	NITHYASHREE R	III	R. Nithyashree

 COURSE CO-ORDINATOR

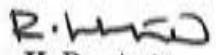
 HoD – Auto

 PRINCIPAL,
 K.S.R COLLEGE OF ENGINEERING
 TIRUCHENGODE - 637 209

K.S.R. College of Engineering (Autonomous)

Department of Automobile Engineering

KSR - Centre of Excellence for Manufacturing

Students Attendance List

S.No.	Reg. No.	Name of The Student	3/7	4/7	5/7	8/7	9/7	12/7	13/7	14/7	15/7	16/7	5/8	6/8	7/8	6/9	7/9	8/9	9/9	10/9	11/9	12/9	13/9	14/9	15/9	16/9	17/9	18/9	19/9	20/9	21/9	22/9	23/9	24/9	25/9	26/9	27/9	28/9	29/9	30/9		
1	1911023	SUGUMAR D	/	/	/	/	/	/	/	/	/	/	/	/	/	/	/	/	/	/	/	/	/	/	/	/	/	/	/	/	/	/	/	/	/	/	/	/	/	/	/	
2	1911006	GOKUL PRANESH C	/	/	/	/	/	/	/	/	/	/	/	/	/	/	/	/	/	/	/	/	/	/	/	/	/	/	/	/	/	/	/	/	/	/	/	/	/	/	/	/
3	1911001	BALACHANDAR A	/	/	/	/	/	/	/	/	/	/	/	/	/	/	/	/	/	/	/	/	/	/	/	/	/	/	/	/	/	/	/	/	/	/	/	/	/	/	/	/
4	1911015	NITHYASHREE R	/	/	/	/	/	/	/	/	/	/	/	/	/	/	/	/	/	/	/	/	/	/	/	/	/	/	/	/	/	/	/	/	/	/	/	/	/	/	/	/



 PRINCIPAL,
 K S R COLLEGE OF ENGINEERING
 TIRUCHENGODE - 637 205.

R. HED

K.S.R COLLEGE OF ENGINEERING (Autonomous), TIRUCHENGODE – 637 215
DEPARTMENT AUTOMOBILE ENGINEERING
STUDENT FEED BACK FORM

(To be returned by them after the end of courses)

Kindly spare a few minutes and fill up the form to help us to improve our efforts in future.

Name of the Programme : *Value added course on "Python Programming"*
19.07.2021 - 03.09.2021, KSRCE-IT LAB

Name of the Student : *P. Sugumar*

Register No. : *1911023*

Kindly evaluate in the following scale by ticking on the relevant grade.

S.No	Items	Very Good	Good	Satisfactory	Unsatisfactory
1	Academic content	✓			
2	Usefulness of Teaching Materials	✓			
3	The content was helpful.		✓		
4	The level of the event was appropriate.	✓			
5	The format was enjoyable		✓		
6	Did you receive all the information?		✓		
7	The speaker had a good understanding of the topics.	✓			
8	Whether the event worth your time?			✓	
9	The length of the event was appropriate.			✓	
10	Is the facilities were adequate and comfortable?	✓			



Date: *03-09-2021*

[Handwritten Signature]
Students Signature

PRINCIPAL,
 K.S.R. COLLEGE OF ENGINEERING
 TIRUCHENGODE 637 215

K.S.R COLLEGE OF ENGINEERING (Autonomous), TIRUCHENGODE – 637 215
DEPARTMENT AUTOMOBILE ENGINEERING
STUDENT FEED BACK FORM

(To be returned by them after the end of courses)

Kindly spare a few minutes and fill up the form to help us to improve our efforts in future.

Name of the Programme : *Value added course on "Python Programming"*
19.07.2021 - 03.09.2021, KSRCE-IT LAB

Name of the Student : *Nithya Shree*
 Register No. : *1911015*

Kindly evaluate in the following scale by ticking on the relevant grade.

S.No	Items	Very Good	Good	Satisfactory	Unsatisfactory
1	Academic content	✓			
2	Usefulness of Teaching Materials			✓	
3	The content was helpful.	✓			
4	The level of the event was appropriate.		✓		
5	The format was enjoyable	✓			
6	Did you receive all the information?	✓			
7	The speaker had a good understanding of the topics.		✓		
8	Whether the event worth your time?	✓			
9	The length of the event was appropriate.		✓		
10	Is the facilities were adequate and comfortable?	✓			



Date: *03.09.2021*

[Signature]
 PRINCIPAL, *R.N. [Signature]*
 K.S.R COLLEGE OF ENGINEERING
 TIRUCHENGODE - 637 209.
 Students Signature

K.S.R COLLEGE OF ENGINEERING (AUTONOMOUS), TIRUCHENGODE – 637215

DEPARTMENT OF AUTOMOBILE ENGINEERING

A VALUE ADDED COURSE ON “PYTHON PROGRAMMING”

Date: 19.07.2021

STUDENT WILLINGNESS NAME LIST

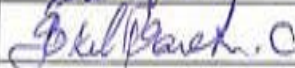
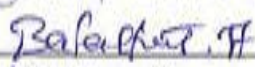
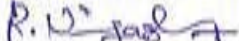
S. No.	Name of the Student	Year	Signature
1	SUGUMAR D	III	
2	GOKUL PRANESH C	III	
3	BALACHANDAR A	III	
4	NITHYASHREE R	III	

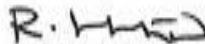

 PRINCIPAL,
 K.S.R COLLEGE OF ENGINEERING,
 TIRUCHENGODE - 637 209.

 HOD-AUTO

Statement of Achievement

Presented To:

D Sugumar

Name

During the Cisco Networking Academy® self-paced course, the student has studied the following Skills:

- the universal concepts of computer programming (i.e. variables, flow control, data structures, algorithms, conditional execution, loops, functions, etc.)
- developer tools and the runtime environment;
- the syntax and semantics of the Python language;
- the fundamentals of object-oriented programming and the way they are adopted in Python;
- the means by which to resolve typical implementation problems;
- the writing of Python programs using standard language infrastructure;
- fundamental programming techniques, best practices, customs and vocabulary, including the most common library function in Python 3;

Maciej Wichary
VP, OpenEDG Python Institute



5 Sep 2021

Date

PRINCIPAL,
K S R COLLEGE OF ENGINEERING,
TIRUCHENGODE - 637 209

By completing the course, the student is now ready to attempt the qualification PCAP-Certified Associate in Python Programming certification, from the OpenEDG Python Institute.

Statement of Achievement

Presented To:

C Gokul Pranesh

Name

During the Cisco Networking Academy® self-paced course, the student has studied the following Skills:

- the universal concepts of computer programming (i.e. variables, flow control, data structures, algorithms, conditional execution, loops, functions, etc.)
- developer tools and the runtime environment;
- the syntax and semantics of the Python language;
- the fundamentals of object-oriented programming and the way they are adopted in Python;
- the means by which to resolve typical implementation problems;
- the writing of Python programs using standard language infrastructure;
- fundamental programming techniques, best practices, customs and vocabulary, including the most common library function in Python 3;

Maciej Wichary
VP, OpenEDG Python Institute



5 Sep 2021

Date

PRINCIPAL,
K. S. R. COLLEGE OF ENGINEERING
TIRUCHENGODE - 637 209

By completing the course, the student is now ready to attempt the qualification PCAP-Certified Associate In Python Programming certification, from the OpenEDG Python Institute.

Statement of Achievement

Presented To:

Balachandar A

Name

During the Cisco Networking Academy® self-paced course, the student has studied the following Skills:

- the universal concepts of computer programming (i.e. variables, flow control, data structures, algorithms, conditional execution, loops, functions, etc.)
- developer tools and the runtime environment;
- the syntax and semantics of the Python language;
- the fundamentals of object-oriented programming and the way they are adopted in Python;
- the means by which to resolve typical implementation problems;
- the writing of Python programs using standard language infrastructure;
- fundamental programming techniques, best practices, customs and vocabulary, including the most common library function in Python 3;

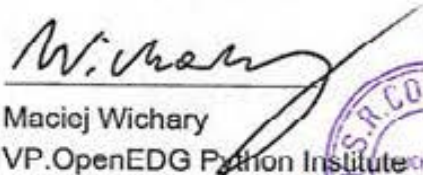
Maciej Wichary
VP, OpenEDG Python Institute

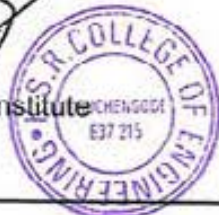

2 Aug 2021

Date



PRINCIPAL,
K. S. R. COLLEGE OF ENGINEERING
TIRUCHENGODE - 637 209

By completing the course, the student is now ready to attempt the qualification PCAP-Certified Associate in Python Programming certification, from the OpenEDG Python Institute.

Statement of Achievement

Presented To:

R Nithyashree

Name

During the Cisco Networking Academy® self-paced course, the student has studied the following Skills:

- the universal concepts of computer programming (i.e. variables, flow control, data structures, algorithms, conditional execution, loops, functions, etc.)
- developer tools and the runtime environment;
- the syntax and semantics of the Python language;
- the fundamentals of object-oriented programming and the way they are adopted in Python;
- the means by which to resolve typical implementation problems;
- the writing of Python programs using standard language infrastructure;
- fundamental programming techniques, best practices, customs and vocabulary, including the most common library function in Python 3;

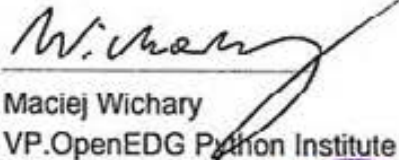
Maciej Wichary
VP.OpenEDG Python Institute

5 Sep 2021

Date

PRINCIPAL,
K. S. R. COLLEGE OF ENGINEERING
TRICHENGODE - 637 209

By completing the course, the student is now ready to attempt the qualification PCAP-Certified Associate in Python Programming certification, from the OpenEDG Python Institute.

K.S.R COLLEGE OF ENGINEERING (AUTONOMOUS)

TIRUCHENGODE - 637215

DEPARTMENT OF CIVIL ENGINEERING

10.08.2021

Submitted to the Principal

Permission is requested to conduct a short term training course on Auto Cadd for UG Civil Engineering students in our CADD Laboratory. The particulars of the Batch details, Amount collected and course duration are as given below:

Proposed Schedule:

No.of Persons : 36
No. of Batches : 01
Mode : Online Mode
Date of Commencement : 16.08.2021
Timing : 03.00 pm – 05.00 pm
No.of hours : 30 hours
Course fee : Rs.5000/-
Course Coordinator : S.Saravanaganesh

S. Saravanaganesh

Staff Coordinator

Reevathi

HoD/Civil

[Signature]

Principal

[Signature]

PRINCIPAL
K.S.R. COLLEGE OF ENGINEERING
K.S.R. KALVI NAGAR,
TIRUCHENGODE-637 215





KSR COLLEGE OF ENGINEERING,

Tiruchengode -637215

(AUTONOMOUS)

DEPARTMENT OF CIVIL ENGINEERING

INAGURATON OF VALUE ADDED COURSE

(VIRTUAL MODE)



Lion Dr. K.S. Rangasamy, MJF
Founder, KSR Group of Institutions



Thiru.R.SRINIVASAN, B.B.M., MISTE.,
Chairman Cum Managing Trustee,
Aarthi Educational and Charitable Trust



Mr. R.Hariharasudhavelan,
CAD Engineer,
CADD Centre, Erode

Topic: Introduction to CAD

Venue: Google Meet Platform

Link: <https://meet.google.com/bqs-dvio-gio>

Date: 25/08/2021 – 01/09/2021 &

Time: 3.00 pm - 5.00 pm



WELCOMES YOU ALL

PRINCIPAL
K.S.R. COLLEGE OF ENGINEERING
K.S.R. KALVI NAGAR,
TIRUCHENGODE-637 215

K.S.R COLLEGE OF ENGINEERING (AUTONOMOUS)

TIRUCHENGODE - 637215

DEPARTMENT OF CIVIL ENGINEERING

VALUE ADDED COURSE (2021-2022)

Course Details: Introduction to CAD

Date: 10.08.2021

Course Duration: 30 Hrs

S.NO	REG.NO	NAME	YEAR
1	1912001	Arulkumaran S	III
2	1912002	Dhileepan K	III
3	1912004	Karunakaran R	III
4	1912005	Kavinraj T	III
5	1912006	Madhankumar P	III
6	1912007	Manickavel T	III
7	1912008	Monish K	III
8	1912009	Nallenthiran R	III
9	1912011	Prabhakaran S	III
10	1912012	Sanjaykumaran D	III
11	1912013	Saravanan M	III
12	1912014	Sathishkumar M	III
13	1912015	Sethuraman M	III
14	1912016	SohailMaqboolBhat	III
15	1912017	Thasmeena A	III
16	1912018	VenuAravind S	III
17	1912501	Naveen V	III
18	1912502	Prakash T	III
19	1912503	Rahul N R	III
20	1912504	Ranjith Kumar P	III
21	2012001	Aravindkumar P	II
22	2012005	Dinesh Kumar R	II
23	2012006	Dineshkumar S	II
24	2012012	Kavin Raj K S	II
25	2012015	Kishoth M	II
26	2012017	Pravinkumar V	II

PRINCIPAL
K.S.R. COLLEGE OF ENGINEERING
K.S.R. KALVI NAGAR,
TIRUCHENGODE-637 215



27	2012018	Santhosh E	II
28	2012019	Santhosh V	II
29	2012020	Srivigneshwar S R	II
30	2012507	Kavinkumar M D	II
31	2012509	Naveen Kumar S	II
32	2012511	Pradeepkumar V	II
33	2012515	Santhosh Kumar M	II
34	2012520	Sugan R	II
35	2012522	Thangamuthu M	II
36	2012524	Yaswin M K	II

S. Soodh

Staff Coordinator

Reethi

HoD



[Signature]

PRINCIPAL
K.S.R. COLLEGE OF ENGINEERING
K.S.R. KALVI NAGAR,
(TIRUCHENGODE-637 215)

Course Details: Introduction to CAD

Date: 12.08.2021

Course Duration: 30 Hrs

S.N o.	Reg.No	Name	16/08	17/08	18/08	19/08	20/08	21/08	23/08	24/08	25/08	26/08	27/08	28/08	30/08	31/08	01/09
1	1912001	Arulkumaran S	/	/	/	/	/	/	/	/	/	/	/	a	/	/	/
2	1912002	Dhileepan K	/	/	/	/	/	/	/	/	/	/	/	/	/	/	/
3	1912004	Karunakaran R	/	/	/	/	/	/	/	/	/	/	/	/	/	/	/
4	1912005	Kavinraj T	/	/	/	/	/	/	/	/	/	/	/	/	/	/	/
5	1912006	Madhankumar P	/	/	/	/	a	/	/	/	/	/	/	/	/	/	/
6	1912007	Manickavel T	/	/	/	/	/	/	/	/	/	/	/	/	/	/	/
7	1912008	Monish K	/	/	/	/	/	/	/	/	/	/	/	/	/	/	/
8	1912009	Nallenthiran R	/	/	/	/	/	/	/	/	/	/	/	/	/	/	/
9	1912011	Prabhakaran S	/	/	/	/	/	/	/	/	/	/	/	/	/	/	/
10	1912012	Sanjaykumaran D	a	/	/	/	/	/	/	/	/	/	/	/	/	/	/
11	1912013	Saravanan M	/	/	/	/	/	/	/	/	/	/	/	/	/	/	/
12	1912014	Sathishkumar M	/	/	/	/	/	/	/	/	/	/	/	/	/	/	/
13	1912015	Sethuraman M	/	/	/	/	/	/	/	/	/	a	/	/	/	/	/
14	1912016	Sohail Maqbool Bhat	/	/	a	/	/	/	/	/	a	/	a	/	/	/	/
15	1912017	Thasmeena A	/	/	/	/	/	/	/	/	/	/	/	/	/	/	/
16	1912018	Venu Aravind S	/	a	/	/	/	/	/	/	/	/	/	/	/	/	/

PRINCIPAL
K.S.R. COLLEGE OF ENGINEERING
K.S.R., KALVI NAGAR,
TIRUCHENGODE-637 215



S.N o.	Reg.No	Name	16/08	17/08	18/08	19/08	20/08	21/08	23/08	24/08	25/08	26/08	27/08	28/08	30/08	31/08	01/09
17	1912501	Naveen V	/	/	/	/	/	/	/	/	/	/	/	/	/	/	/
18	1912502	Prakash T	/	/	/	/	/	/	/	/	/	/	/	/	/	/	/
19	1912503	Rahul N R	/	/	/	/	/	/	/	/	/	/	/	/	/	/	/
20	1912504	Ranjith Kumar P	/	/	/	/	/	/	/	/	/	/	/	/	/	/	/
21	2012001	Aravindkumar P	/	/	/	/	/	/	/	/	/	/	/	/	/	/	/
22	2012005	Dinesh Kumar R	/	/	/	/	/	/	/	/	/	/	/	/	/	/	/
23	2012006	Dineshkumar S	/	a	/	/	/	/	/	/	/	/	/	/	/	a	/
24	2012012	Kavin Raj K S	/	/	/	/	/	/	/	/	/	/	/	/	/	/	/
25	2012013	Kishoth M	/	/	/	/	/	/	/	/	/	/	/	/	/	/	/
26	2012017	Pravinkumar V	/	/	/	/	/	/	/	/	/	/	/	/	/	/	/
27	2012018	Santhosh E	/	/	/	/	/	a	/	/	a	/	/	/	/	/	/
28	2012019	Santhosh V	a	/	/	/	/	/	/	/	/	/	/	a	/	/	/
29	2012020	Srivigneshwar S R	/	/	/	/	/	/	/	/	/	/	/	/	/	/	/
30	2012507	Kavinkumar M D	/	/	/	/	/	/	/	/	/	/	/	/	/	/	/
31	2012509	Naveen Kumar S	/	/	/	/	/	/	/	/	/	/	/	/	/	/	/
32	2012511	Pradcepkumar V	/	/	/	/	/	/	/	/	/	/	/	/	/	/	/
33	2012515	Santhosh Kumar M	/	/	/	/	/	/	a	/	/	/	/	/	a	/	/
34	2012520	Sugan R	/	/	/	/	/	/	/	/	/	/	/	/	/	/	/
35	2012522	Thangamuthu M	/	/	/	/	a	/	/	/	/	/	/	/	/	/	/
36	2012524	Yaswin M K	/	/	/	/	/	/	/	/	/	/	/	/	/	/	/

S. Senthil

Staff Coordinator



Reethi
HoD

[Signature]
PRINCIPAL
K.S.R. COLLEGE OF ENGINEERING
K.S.R. KALVI NAGAR,
TIRUCHENGODE-637 215

Certificate of Participation

CADD CENTRE
Driving Digital Design



This is to certify that **P. MADHANKUMAR**

has participated in **"Introduction to CAD"**

a complimentary training program conducted by

**CADD Centre Training Services,
Erode**

During August 2021

Venue: K.S.R College Of Engineering, Tiruchengode

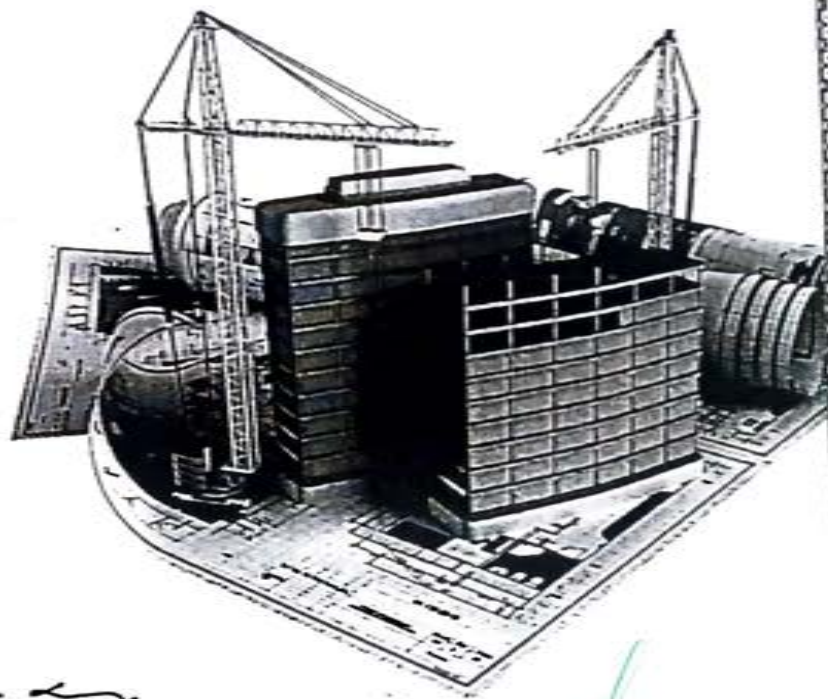

S. Karaiadiselvan - Managing Director

PRINCIPAL
K.S.R. COLLEGE OF ENGINEERING
K.S.R. KALVI NAGAR,
TIRUCHENGODE-637 215

..... CADD Centre and CADD Centre logo are registered trademarks of CADD Centre Training Services Private Limited. All brand names and trademarks belong to respective owners.

A CSR Initiative of CADD Centre

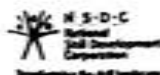

AUTODESK | **cādence** | **ANSYS** | **Bentley** | **SolidWorks** | **ORACLE** | **PTC** | **PC SCHEMATIC**
PRIMAVERA

CADD Centre uses legal software from the above software developers. CADD Centre students are employed in many reputed companies and universities in several countries worldwide.

www.caddcentre.com

K.S.R COLLEGE OF ENGINEERING (AUTONOMOUS)
TIRUCHENGODE - 637215
DEPARTMENT OF CIVIL ENGINEERING

01.09.2021

Submitted to the Principal

Permission is requested to conduct a short term training course on Programming Essentials in Python for III year Civil Engineering students. The particulars of the Batch details, Amount collected and course duration are as given below:

Proposed Schedule:

No.of Persons	: 20
No. of Batches	: 01
Mode	: Online Mode
Date of Commencement	: 06.09.2021
No.of hours	: 70 hours
Course fee	: Rs.13000/-
Course Coordinator	: S.Saravanaganesh



Staff Coordinator

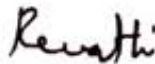

HoD/Civil



Principal



PRINCIPAL
K.S.R. COLLEGE OF ENGINEERING
K.S.R. KALVI NAGAR,
TIRUCHENGODE-637 215



KSR COLLEGE OF ENGINEERING,

Tiruchengode -637215

(AUTONOMOUS)

DEPARTMENT OF CIVIL ENGINEERING

INVITATION

ICT ACADEMY SPONSORED

VALUE ADDED COURSE

ON

“PROGRAMMING ESSENTIALS IN PYTHON”

in the presence of

Lion Dr. K.S. Rangasamy, MJF
Founder, KSR Group of Institutions

Thiru.R.Srinivasan, B.B.M., MISTE.
Chairman cum Managing Trustee,
Aarthi Educational and Charitable Trust

Dr.P.Senthilkumar, Ph.D(IITM)
Principal, K.S.R College of Engineering

Platform: Cisco Webex

Link:

<https://rgniipm.webex.com/rgniipm/j.php?MTID=mccf54773c499e1e25183c3c3b18be3f9>

Date: 06/09/2021



PRINCIPAL
K.S.R. COLLEGE OF ENGINEERING
K.S.R. KALVI NAGAR,
TIRUCHENGODE-637 215

WELCOMES YOU ALL

K.S.R COLLEGE OF ENGINEERING (AUTONOMOUS)

TIRUCHENGODE - 637215

DEPARTMENT OF CIVIL ENGINEERING

VALUE ADDED COURSE (2021-2022)

Course Details: Cisco Python Programming

Date: 01.09.2021

Course Duration: 70 Hrs

S.NO	REG.NO	NAME
1	1912001	Arulkumaran S
2	1912003	Gowtham M
3	1912004	Karunakaran R
4	1912005	Kavinraj T
5	1912006	Madhankumar P
6	1912007	Manickavel T
7	1912008	Monish K
8	1912009	Nallenthiran R
9	1912011	Prabhakaran S
10	1912012	Sanjaykumaran D
11	1912013	Saravanan M
12	1912014	Sathishkumar M
13	1912015	Sethuraman M
14	1912016	Sohail Maqbool Bhat
15	1912017	Thasmeena A
16	1912018	Venu Aravind S
17	1912501	Naveen V
18	1912502	Prakash T
19	1912504	Ranjith Kumar P
20	1912505	Vineeth S

es. smooth

Staff Coordinator

Revathi

HoD/Civil



[Signature]
PRINCIPAL
K.S.R. COLLEGE OF ENGINEERING
K.S.R. KALVI NAGAR,
TIRUCHENGODE-637 215



**K.S.R.College of Engineering (Autonomous),
Tiruchengode -637 215**

Networking
CISCO Academy

CISCO NetAcad Python - PCAP Certificates Attendance

S.No	Student ID	Name	Gender	Degree	Department	Mail ID	No.of Hours present
1	S1589107	V.Naveen	Male	B.E	Civil	naveenvelusamy0110@gmail.com	70
2	S1589221	Sethuraman M	Male	B.E	Civil	sethuraman0317@gmail.com	68
3	S1589222	S.Venu Aravind	Male	B.E	Civil	aravind15082001@gmail.com	65
4	S1589223	R.Nallenthiran	Male	B.E	Civil	nallenthiranraja44@gmail.com	70
5	S1589224	S.Prabhakaran	Male	B.E	Civil	skyprabha21@gmail.com	70
6	S1589225	Saravanan M	Male	B.E	Civil	saravanan26022001@gmail.com	70
7	S1589227	Gowtham Murugan	Male	B.E	Civil	gowtham1342451@gmail.com	68
8	S1589228	T.Manickavel	Male	B.E	Civil	manickavel01@gmail.com	68
9	S1589229	P. Madhankumar	Male	B.E	Civil	havocmadhan72@gmail.com	70
10	S1589230	K.Monish	Male	B.E	Civil	monishpmk23@gmail.com	70
11	S1589231	K.Dhileepan	Male	B.E	Civil	abddhileep@gmail.com	65
12	S1589232	Kavin Raj, T	Male	B.E	Civil	rkavin313@gmail.com	68
13	S1589233	S.Arulkumaran	Male	B.E	Civil	arul9445578828@gmail.com	65
14	S1589234	Vineeth.S	Male	B.E	Civil	vineethsiva9552@gmail.com	68
15	S1589235	Sathishkumar.M	Male	B.E	Civil	sathishkumarmcivil2019@gmail.com	65
16	S1589236	T.Prakash	Male	BE	Civil	itprakash2001@gmail.com	68
17	S1589237	Thasmeena.A	Female	B.E	Civil	thasmeenacivil2019@gmail.com	70
18	S1589238	Karunakaran.R	Male	B.E	Civil	rkarunakaranr@gmail.com	68
19	S1589239	Sohail Maqbool Bhat	Male	B.E	Civil	sohailbhat2108@gmail.com	68
20	S1589261	Ranjith Kumar P	Male	B.E	Civil	rk5996509@gmail.com	68



PRINCIPAL
K.S.R. COLLEGE OF ENGINEERING
K.S.R. KALVI NAGAR,
TIRUCHENGODE-637,215

Certificate of Proficiency

C. No: S21-16-58

Date: 12 Oct 2021

This is to certify that

SANJAY KUMARAN D

of KSR College of Engineering, Namakkal bearing ID S1589258

has successfully completed all the requirements for

Programming Essentials in Python

through assessment administered by ICT Academy and

has been awarded **D** Grade.

Networking
CISCO Academy



PRINCIPAL,
K.S.R. COLLEGE OF ENGINEERING
K.S.R. KALVI NAGAR,
TIRUCHENGODE-637.215

Dr B Anbuthambi
President, ICT Academy

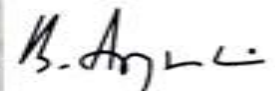

K.S.R. COLLEGE OF ENGINEERING (Autonomous)(An Autonomous Institution, approved by AICTE, Accredited by NAAC with A grade
& Affiliated to Anna University)K.S.R. Kalvi Nagar, Tiruchengode - 637 215,
Namakkal District, Tamil Nadu

Phone: 04288-274213

Fax: 04288-274757

E - mail: principal@ksrce.ac.in

Department of Computer Science and Engineering

Phone :9842761811(HoD)

E - mail:ksrcecsdept@gmail.com

Date: 11.06.2022

Submitted to Principal:

Respected sir,

Sub.: Permission for conducting Value Added Course on "Knowledge Sharing: Emerging Trends in IT industry"- Reg.

Our department conducts Value Added Course on "Knowledge Sharing: Emerging Trends in IT industry" to first year students of Computer Science and Engineering held on 20.06.2022 to 24.06.2022, Time 09.30am to 4.30pm. Hence, we request to give me permission for the same.

Thanking You,

Coordinator Details	Resource Person Details
Dr.A. Rajivkannan Professor & Head, Dept. of CSE Mr. M. Namasivayam Assistant Professor, Dept. of CSE.	Dr. N. S. Nithya Professor, Dept. of CSE. K.S.R. College of Engineering. Dr. V.Vennila Associate Professor, Dept. of CSE. K.S.R. College of Engineering.

M. Namasivayam
11/6/22
Faculty In-Charge

Sh. S. S. S.
Signature of HoD
11/6/22

[Signature]
Principal

PRINCIPAL
K.S.R. COLLEGE OF ENGINEERING
K.S.R. KALVI NAGAR,
TIRUCHENGODE-637 215

Copy to:
Association Incharge file and HoD file



DATE:12.06.2022

TIME:09:30AM

DEPARTMENT CIRCULAR

Classification	ROUTINE	URGENT
ORIGINATOR: HoD-CSE	CIRCULATED TO: All FIRST YEAR STUDENTS	

Sub: Value Added Course – “Knowledge sharing: Emerging Trends in IT industry” – Reg

It is planned to conduct a Value Added Course for First year CSE Students on the topic of “Knowledge sharing: Emerging Trends in IT Industry” from 20.06.2022 to 24.06.2022, Time 09.30 am - 4.30 pm at CSE NET LAB, C-Block Third Floor. All the Willing students should register their name to Course Coordinator Mr. M. Namasivayam, Assistant Professor/CSE. The resource person and other details are given below.

Resource Persons:

Dr. N.S. Nithya/Professor/CSE

Dr. V. Vennila/ASP/CSE

Course Coordinator:

Dr.A. Rajivkannan

Professor & Head, Dept. of CSE.

Mr.M. Namasivayam

Assistant Professor, Dept. of CSE.

Course Content:

- Introduction
- Big Data
- Artificial Intelligence
- Internet of Things
- Cloud Computing
- Block Chain

Instructions to the students through Course Coordinator

1. Dress Code (Self Grooming, Formal wear with shoes)
2. Discipline and attendance is compulsory to attend the program.
3. Punctuality

If any student not follows the above, he/she may not be allowed to proceed further.



PRINCIPAL
K.S.R. COLLEGE OF ENGINEERING
K.S.R. KALVI NAGAR,
TIRUCHENGODE-637 215

HoD-CSE
[Signature]

Date: 24.06.2022

K.S.R. COLLEGE OF ENGINEERING (Autonomous)
(An Autonomous Institution, approved by AICTE, Accredited by NAAC with A grade
& Affiliated to Anna University)

**K.S.R. Kalvi Nagar, Tiruchengode – 637 215,
Namakkal District, Tamil Nadu**

Phone: 04288-274213

Fax: 04288-274757

E - mail: principal@ksrce.ac.in

Department of Computer Science and Engineering

Phone :9842761811(HoD)

E - mail:ksrcecsedept@gmail.com

Value added Course

On

“Knowledge Sharing: Emerging Trends in IT industry”

Coordinator Details	Resource Person Details
Dr.A. Rajivkannan Professor & Head, Dept. of CSE. K.S.R. College of Engineering. Mr. M. Namasivayam Assistant Professor, Dept. of CSE. K.S.R. College of Engineering.	Dr. N. S. Nithya Professor, Dept. of CSE. K.S.R. College of Engineering. Dr. V.Vennila Associate Professor, Dept. of CSE. K.S.R. College of Engineering.

Course Outcomes:

Through this course student will be able to:

- Learning the emerging trends from its scratch: its syntax, idioms, patterns and styles.
- Illustrate the essentials of the concepts, and learn how to learn about other parts of the industry trends when you need them.
- Understand the features of IT Industry to apply on real world problems.
- Learn the basics of learning problems with hypothesis and version spaces.

 COURSE CO-ORDINATOR

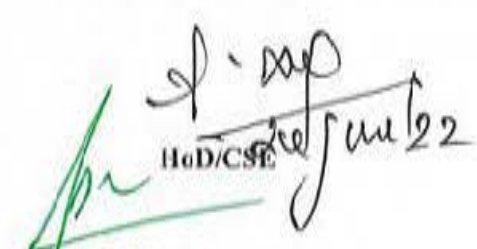

 PRINCIPAL

K.S.R.COLLEGE OF ENGINEERING
 K.S.R.Kalvi Nagar, Tiruchengode-637 215
 Namakkal Dist., Tamilnadu

K.S.R. COLLEGE OF ENGINEERING (Autonomous), TIRUCHENGODE – 637215
DEPARTMENT OF COMPUTER SCIENCE AND ENGINEERING

Value Added Course "Knowledge Sharing: Emerging Trends in IT industry"

Course Schedule

Date: 12.06.2022

Timings: 9.30 am to 4.30 pm

S.No	Date	Course Contents
1	20.06.2022	<ul style="list-style-type: none"> ✓ Introduction to emerging trends ✓ Characteristics of Big Data ✓ Data Analytics
2	21.06.2022	<ul style="list-style-type: none"> ✓ Artificial Intelligence ✓ Machine Learning ✓ Natural Language Processing (NLP) ✓ Virtual Reality ✓ Augmented Reality ✓ Robotics
3	22.06.2022	<ul style="list-style-type: none"> ✓ Internet of Things: Introduction ✓ Web of Things ✓ Sensors, Smart Cities
4	23.06.2022	<ul style="list-style-type: none"> ✓ Cloud Computing: Cloud Services ✓ Infrastructure as a Service ✓ Platform as a Service ✓ Software as a Service
5	24.06.2022	<ul style="list-style-type: none"> ✓ Blockchain: Introduction ✓ Blockchain Network, Mining Mechanism ✓ Cryptocurrency

M. Vallabhan
12/6/22
COURSE COORDINATOR



[Signature]
HOD / CSE
12/6/22

[Signature]
PRINCIPAL
K.S.R. COLLEGE OF ENGINEERING
K.S.R. KALVI NAGAR,
TIRUCHENGODE-637 215

K.S.R. COLLEGE OF ENGINEERING, TIRUCHENGODE – 637 215.

(AUTONOMOUS)

DEPARTMENT OF COMPUTER SCIENCE AND ENGINEERING

FACULTY PROFILE

01. Name : N.S.Nithya
02. Designation : Associate.Professor
03. Date of Birth : 5.4.1980
04. Date of Joining : 13.12.2010
05. Qualification :



Sl. No.	Name of the Degree	Specialization	Name of the Institution / University	Name of the University	Year of		Class & % of Marks
					Admitted	Completed	
1	PhD	CSE	K.S.Rangasamy Collge of Technology	Anna University, Coimbatore	2009	2015	-
2.	M.E	CSE	College of Engineering, Guindy	Anna University, Chennai	2006	2008	First class& 72.6%
3.	B.E	EEE	Erode Sengunthar Engineering college,	Bharathiyar University Coimbatore	1997	2001	First class& 76%

06. Experience, Promotion & Designation Details (Chronological):

a. Teaching:

Sl. No.	Name of the Institution	Designation	Nature of work	Period	
				From	To
1.	M.P.N.M.J.Engineering College	Lecturer	Teaching	11.8.2003	31.05.2006
2.	Velalar College of Engineering and Technology	Lecturer	Teaching	3.06.2008	30.11.2009
		Asst.Professor		1.12.2009	4.12.2010
3.	K.S.R.College Of Engineering	Asst.Professor	Teaching	13.12.2010	30.06.2012
		Assoc.Professor		01.07.2012	Till now
Total year of Experience(s)				12years	

b. Industry:

Sl. No.	Name of the Organization	Designation	Nature of work	Period	
				From	To
1	ALFA Engineers	Design Engineer	Panel designing	02.07.2001	09.08.2003
Total year of Experience(s)				2years	



PRINCIPAL
K.S.R.COLLEGE OF ENGINEERING
K.S.R.Kalvi Nagar, Tiruchengode-637 215
Namakkal Dist., Tamilnadu

07. Publication Details:**a. Conference Details:****National:**

Sl. No.	Title of the Research paper	Name of the author(s)	Publisher / Journal Name	Month & Year of publication	DOI & ISSN No.	IF / SJR / SNIP / H index / K index
2008-09						
1	Mobile Agent Based QoS Routing in Mobile Ad-hoc Networks	N.S.Nithya & Dr.K.Duraiswamy	National conference on Advanced Computing Technologies(BIT,Sathy)	April 2008		
2009-10						
2	Extended Naïve Bayes Techniques for classification and Retrieval of Data	N.S.Nithya & Dr.K.Duraiswamy	National Conference on Recent Trends in Computer Applications (VCET,Thindal)	March 2010	-	-
2010-2011						
3	Prediction of Heart Disease by Frequent Feature selection Method	N.S.Nithya & S.Sarumathi	National conference on Recent Trends in Advanced Computing (NCRTAC-11)	October 2011	-	-
2012-2013						
4	Mutual Information and IFS Based Similarity Measures for Micro Array Gene Expression	N.S.Nithya	National Conference on Networking and Communication Systems	Feb 2013	-	-



PRINCIPAL
K.S.R. COLLEGE OF ENGINEERING
K.S.R. Kalvi Nagar, Tiruchengode-637 215
Namakkal Dist., Tamilnadu

22.	73152113043	JAYAMURUGAN V	I-A	/	/	/	/	/	/	/	/	/	/
23.	73152113044	JAYASHREE A	I-A	/	/	/	a	/	/	/	/	a	/
24.	73152113047	KAMALESH S	I-A	/	/	/	/	/	/	/	/	/	/
25.	73152113048	KARTHICK R	I-A	/	/	/	/	/	/	/	/	/	/
26.	73152113053	KEERTHANA A	I-A	a	/	/	/	/	/	/	/	a	/
27.	73152113056	KESAVAN K	I-A	/	/	a	/	/	a	/	/	/	/
28.	73152113060	MADHUNANDHA G	I-A	/	/	/	/	/	/	/	/	/	/
29.	73152113061	MANI MOZHI K	I-A	/	/	/	a	/	/	/	/	/	/
30.	73152113062	MANOJ N	I-A	/	/	/	/	/	/	a	/	/	/
31.	73152113067	MOHAN RAJ V B	I-B	/	/	/	/	/	/	/	/	/	/
32.	73152113068	MOHANAMURALI G	I-B	/	a	/	/	/	/	/	/	/	/
33.	73152113075	PRABHAKARAN S	I-B	/	/	/	/	/	/	/	/	/	/
34.	73152113077	PRAVEEN KUMAR S	I-B	/	/	/	/	/	/	/	/	/	/
35.	73152113081	PRITHIV RAJ R	I-B	/	/	/	/	/	a	/	/	/	/
36.	73152113082	PRIYADARSHINI K	I-B	/	/	a	/	/	/	/	/	/	/
37.	73152113083	RAGHUL B	I-B	/	/	/	/	/	/	/	/	/	/
38.	73152113085	RANJITH S	I-B	/	/	/	/	/	/	/	a	/	/
39.	73152113086	RANJITHKUMAR VR	I-B	/	/	/	a	/	/	/	/	/	a
40.	73152113087	REVATHI P	I-B	/	/	/	/	/	/	/	/	/	a
41.	73152113089	SABESH MURALI M	I-B	/	/	/	/	/	/	/	/	/	/
42.	73152113090	SAHANA N	I-B	/	/	/	/	/	/	/	/	/	/
43.	73152113092	SAKTHIPRIYA P	I-B	/	/	/	a	/	/	/	/	/	a
44.	73152113093	SAKTHIVEL RAJAN N	I-B	/	/	/	/	/	/	/	/	a	/
45.	73152113094	SANGEETHA S	I-B	/	/	/	/	/	/	/	/	/	/
46.	73152113096	SARAVANAKUMAR N	I-B	/	a	/	/	/	/	/	/	/	/
47.	73152113097	SATHISH K	I-B	/	/	/	/	/	/	/	/	/	/
48.	73152113102	SRIDHAR J	I-B	/	/	/	/	/	/	/	/	/	/
49.	73152113103	SRINIVASAN S	I-B	a	/	/	/	/	/	/	/	/	/
50.	73152113109	SURENDHAR N D	I-B	/	/	/	/	/	/	/	/	/	/
51.	73152113111	SYEDIRFAN S	I-B	/	a	a	/	/	/	/	/	/	/

52.	73152113112	THRISHA S	-B	/	/	/	9	/	/	/	/	/	/
53.	73152113114	VARUN Y	-B	/	/	/	/	9	/	/	/	/	/
54.	73152113115	VASANTH K	-B	/	9	/	/	/	/	/	/	/	/
55.	73152113116	VASANTH V	-B	/	/	/	/	9	/	/	/	/	/
56.	73152113118	VENKATESH G	-B	/	/	/	/	/	/	/	/	/	/
57.	73152113119	VIGNESH C	-B	/	9	/	/	/	/	/	/	/	/
58.	73152113121	VIJAY P	-B	/	/	/	/	/	/	/	/	/	/
59.	73152113122	VDAYAKUMAR R	-B	/	/	/	/	/	/	/	/	/	/
60.	73152113123	VIMAL P	-B	/	/	/	/	/	9	/	/	/	/

COURSE-COORDINATOR

HoD/CSE



PRINCIPAL
K.S.R. COLLEGE OF ENGINEERING
 K.S.R. Kalvi Nagar, Tiruchengode-637 215
 Namakkal Dist., Tamilnadu

K.S.R COLLEGE OF ENGINEERING, TIRUCHENGODE-637 215

DEPARTMENT OF CSE

VALUE ADDED COURSE ON "KNOWLEDGE SHARING: EMERGING TRENDS
IN IT INDUSTRY"

Date:15.06.2022

Willing Name List

S.No	Reg.No	Name	Class
1.	73152113001	ABINAYA R	I-A
2.	73152113002	ABINESH P	I-A
3.	73152113007	ARULKUMAR S	I-A
4.	73152113008	ARULMURUGAN B	I-A
5.	73152113013	BALAMAHESHWARI S	I-A
6.	73152113014	BARANIDHARAN M	I-A
7.	73152113018	BHARATHVAJ M	I-A
8.	73152113019	CHANDNI N	I-A
9.	73152113020	DEEPAK S [09-07-2003]	I-A
10.	73152113021	DEEPAK S [11-03-2004]	I-A
11.	73152113022	DEEPAN R	I-A
12.	73152113025	DHARSHINI M	I-A
13.	73152113027	DIVYA M S	I-A
14.	73152113029	GAYATHRI A	I-A
15.	73152113031	GOKUL S	I-A
16.	73152113034	GURU PRIYA L	I-A
17.	73152113036	HAREESH G T	I-A
18.	73152113038	HARISH P [13.12.2003]	I-A
19.	73152113039	HARISH P [15.12.2003]	I-A
20.	73152113040	IMRAN A	I-A
21.	73152113042	JAYADEV K	I-A
22.	73152113043	JAYAMURUGAN V	I-A
23.	73152113044	JAYASHREE A	I-A
24.	73152113047	KAMALESH S	I-A
25.	73152113048	KARTHICK R	I-A
26.	73152113053	KEERTHANA A	I-A
27.	73152113056	KESAVAN K	I-A
28.	73152113060	MADHUNANDHA G	I-A
29.	73152113061	MANI MOZHI K	I-A
30.	73152113062	MANOJ N	I-A
31.	73152113067	MOHAN RAJ V B	I-B
32.	73152113068	MOHANAMURALI G	I-B
33.	73152113075	PRABHAKARAN S	I-B
34.	73152113077	PRAVEEN KUMAR S	I-B
35.	73152113081	PRITHIV RAJ R	I-B

K.S.R. COLLEGE OF ENGINEERING (AUTONOMOUS), TIRUCHENGODE - 637 215

DEPARTMENT OF CSE

Academic Year 2021-2022Value Added Course on "Knowledge Sharing: Emerging Trends in IT Industry"**FEEDBACK FORM**

Kindly provide your valuable feedback about this value added course to course to improve the quality in future.

Name of the Student. : VIGNESH C

Register No. : 73152113119

Kindly evaluate in the following scale by ticking on the relevant grade.

1. Excellent 2. Good 3. Satisfactory 4. Poor

Description	Excellent	Good	Satisfactory	Poor
The course as a whole was:	✓			
The course content was:	✓			
The instructor's contribution to the course was:		✓		
The instructor's effectiveness in teaching the subject matter was:		✓		
Explanations by instructor were:		✓		
Encouragement given to students to participate was:	✓			
Amount you learned was:	✓			
Relevance of course content was:		✓		
Amount of assigned work was:		✓		
Relevance to industry and placement opportunities	✓			

Date: 24/08/2022



C. Vignesh
Signature

PRINCIPAL

K.S.R. COLLEGE OF ENGINEERING
K.S.R. Kalvi Nagar, Tiruchengode-637 215
Namakkal Dist., Tamilnadu

K.S.R. COLLEGE OF ENGINEERING (AUTONOMOUS), TIRUCHENGODE - 637 215

DEPARTMENT OF CSE

Academic Year 2021-2022Value Added Course on "Knowledge Sharing: Emerging Trends in IT industry"FEEDBACK FORM

Kindly provide your valuable feedback about this value added course to course to improve the quality in future.

Name of the Student : SARATHI VEJ RAJAN NRegister No. : 7315213093

Kindly evaluate in the following scale by ticking on the relevant grade.

1. Excellent 2. Good 3. Satisfactory 4. Poor

Description	Excellent	Good	Satisfactory	Poor
The course as a whole was:	<input checked="" type="checkbox"/>	<input type="checkbox"/>	<input type="checkbox"/>	<input type="checkbox"/>
The course content was:	<input type="checkbox"/>	<input checked="" type="checkbox"/>	<input type="checkbox"/>	<input type="checkbox"/>
The instructor's contribution to the course was:	<input checked="" type="checkbox"/>	<input type="checkbox"/>	<input type="checkbox"/>	<input type="checkbox"/>
The instructor's effectiveness in teaching the subject matter was:	<input type="checkbox"/>	<input checked="" type="checkbox"/>	<input type="checkbox"/>	<input type="checkbox"/>
Explanations by instructor were:	<input checked="" type="checkbox"/>	<input type="checkbox"/>	<input type="checkbox"/>	<input type="checkbox"/>
Encouragement given to students to participate was:	<input type="checkbox"/>	<input checked="" type="checkbox"/>	<input type="checkbox"/>	<input type="checkbox"/>
Amount you learned was:	<input checked="" type="checkbox"/>	<input type="checkbox"/>	<input type="checkbox"/>	<input type="checkbox"/>
Relevance of course content was:	<input type="checkbox"/>	<input checked="" type="checkbox"/>	<input type="checkbox"/>	<input type="checkbox"/>
Amount of assigned work was:	<input checked="" type="checkbox"/>	<input type="checkbox"/>	<input type="checkbox"/>	<input type="checkbox"/>
Relevance to industry and placement opportunities	<input type="checkbox"/>	<input checked="" type="checkbox"/>	<input type="checkbox"/>	<input type="checkbox"/>

Date: 24.6.22

 PRINCIPAL
 K.S.R. COLLEGE OF ENGINEERING
 Page 1 / K.S.R. Kalvi Nagar, Tiruchengode-637 215
 Namakkal Dist., Tamilnadu

Signature

K.S.R. COLLEGE OF ENGINEERING (AUTONOMOUS), TIRUCHENGODE - 637 215

DEPARTMENT OF CSE

Academic Year 2021-2022Value Added Course on "Knowledge Sharing: Emerging Trends in IT industry"FEEDBACK FORM

Kindly provide your valuable feedback about this value added course to course to improve the quality in future.

Name of the Student : VISA Y P
Register No. : 73152113121

Kindly evaluate in the following scale by ticking on the relevant grade.

1. Excellent 2. Good 3. Satisfactory 4. Poor

Description	Excellent	Good	Satisfactory	Poor
The course as a whole was:	<input checked="" type="checkbox"/>	<input type="checkbox"/>	<input type="checkbox"/>	<input type="checkbox"/>
The course content was:	<input type="checkbox"/>	<input checked="" type="checkbox"/>	<input type="checkbox"/>	<input type="checkbox"/>
The instructor's contribution to the course was:	<input type="checkbox"/>	<input type="checkbox"/>	<input type="checkbox"/>	<input type="checkbox"/>
The instructor's effectiveness in teaching the subject matter was:	<input type="checkbox"/>	<input type="checkbox"/>	<input type="checkbox"/>	<input type="checkbox"/>
Explanations by instructor were:	<input type="checkbox"/>	<input checked="" type="checkbox"/>	<input type="checkbox"/>	<input type="checkbox"/>
Encouragement given to students to participate was:	<input type="checkbox"/>	<input type="checkbox"/>	<input type="checkbox"/>	<input type="checkbox"/>
Amount you learned was:	<input type="checkbox"/>	<input type="checkbox"/>	<input type="checkbox"/>	<input type="checkbox"/>
Relevance of course content was:	<input type="checkbox"/>	<input type="checkbox"/>	<input type="checkbox"/>	<input type="checkbox"/>
Amount of assigned work was:	<input type="checkbox"/>	<input type="checkbox"/>	<input type="checkbox"/>	<input type="checkbox"/>
Relevance to industry and placement opportunities	<input checked="" type="checkbox"/>	<input type="checkbox"/>	<input type="checkbox"/>	<input type="checkbox"/>

Date: 24-06-2022



Page 1/1

[Signature]
PRINCIPAL
K.S.R. COLLEGE OF ENGINEERING
K.S.R. Kalvi Nagar, Tiruchengode-637 215
Namakkal Dist., Tamilnadu

[Signature]
Signature

K.S.R. COLLEGE OF ENGINEERING (AUTONOMOUS), TIRUCHENGODE - 637 215

DEPARTMENT OF CSE

Academic Year 2021-2022Value Added Course on "Knowledge Sharing: Emerging Trends in IT Industry"FEEDBACK FORM

Kindly provide your valuable feedback about this value added course to course to improve the quality in future.

Name of the Student : MANJUN
Register No. : 73152113062

Kindly evaluate in the following scale by ticking on the relevant grade.

1. Excellent Good 3. Satisfactory 4. Poor

Description	Excellent	Good	Satisfactory	Poor
The course as a whole was:	<input checked="" type="checkbox"/>	<input checked="" type="checkbox"/>		
The course content was:	<input checked="" type="checkbox"/>			
The instructor's contribution to the course was:				
The instructor's effectiveness in teaching the subject matter was:				
Explanations by instructor were:				
Encouragement given to students to participate was:	<input checked="" type="checkbox"/>	<input checked="" type="checkbox"/>		
Amount you learned was:	<input checked="" type="checkbox"/>			
Relevance of course content was:	<input checked="" type="checkbox"/>			
Amount of assigned work was:	<input checked="" type="checkbox"/>			
Relevance to industry and placement opportunities	<input checked="" type="checkbox"/>			

Date: 24-06-2022



Page 1/1

Signature
PRINCIPAL
K.S.R. COLLEGE OF ENGINEERING
K.S.R. Kalvi Nagar, Tiruchengode-637 215
Namakkal Dist., Tamilnadu

K.S.R. COLLEGE OF ENGINEERING (AUTONOMOUS), TIRUCHENGODE - 637 215

DEPARTMENT OF CSE

Academic Year 2021-2022Value Added Course on " Knowledge Sharing: Emerging Trends in IT industry"**FEEDBACK FORM**

Kindly provide your valuable feedback about this value added course to course to improve the quality in future.

Name of the Student : Arul Kumar SRegister No. : 78152113007

Kindly evaluate in the following scale by ticking on the relevant grade.

1. Excellent 2. Good 3. Satisfactory 4. Poor

Description	Excellent	Good	Satisfactory	Poor
The course as a whole was:	<input checked="" type="checkbox"/>			
The course content was:	<input checked="" type="checkbox"/>			
The instructor's contribution to the course was:	<input checked="" type="checkbox"/>			
The instructor's effectiveness in teaching the subject matter was:		<input checked="" type="checkbox"/>		
Explanations by instructor were:	<input checked="" type="checkbox"/>			
Encouragement given to students to participate was:		<input checked="" type="checkbox"/>		
Amount you learned was:	<input checked="" type="checkbox"/>			
Relevance of course content was:	<input checked="" type="checkbox"/>			
Amount of assigned work was:	<input checked="" type="checkbox"/>			
Relevance to industry and placement opportunities	<input checked="" type="checkbox"/>			

Date: 24-06-2022

Arul Kumar S
Signature



PRINCIPAL
K.S.R. COLLEGE OF ENGINEERING
Page 6/8, Kalvi Nagar, Tiruchengode-637 215
Namakkal Dist., Tamilnadu



K.S.R.

COLLEGE OF ENGINEERING

[Autonomous]

TIRUCHENGODE-637215.
TAMILNADU, INDIA.



Department of Computer Science and Engineering

Certificate of Participation

This is to certify that Mr./Ms. Gokul S
of K.S.R. COLLEGE OF ENGINEERING participated in Value
Added Training Program on “**KNOWLEDGE SHARING:
EMERGING TRENDS IN IT INDUSTRY**” organized by
Department of Computer Science and Engineering in
K.S.R. College of Engineering held from 20th to 24th July, 2022.

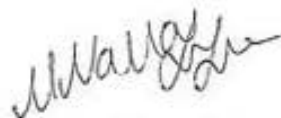
Co-ordinator

HoD



Principal
K.S.R. COLLEGE OF ENGINEERING
K.S.R. KALAI NAGAR,
TIRUCHENGODE-637 215



K.S.R.

COLLEGE OF ENGINEERING

[Autonomous]

TIRUCHENGODE-637215.
TAMILNADU, INDIA.



Department of Computer Science and Engineering

Certificate of Participation

This is to certify that Mr./Ms. SAHANE N

of K.S.R.COLLEGE OF ENGINEERING participated in Value Added Training Program on “**KNOWLEDGE SHARING: EMERGING TRENDS IN IT INDUSTRY**” organized by Department of Computer Science and Engineering in K.S.R.College of Engineering held from 20th to 24th July, 2022.

Co-ordinator

HoD



Principal
K.S.R. COLLEGE OF ENGINEERING
K.S.R. KALINAGAR,
TIRUCHENGODE-637 215



K.S.R.

COLLEGE OF ENGINEERING

[Autonomous]

TIRUCHENGODE-637216.
TAMILNADU,INDIA.



Department of Computer Science and Engineering

Certificate of Participation

This is to certify that Mr./Ms. VIJAY.D
of K.S.R.COLLEGE OF ENGINEERING participated in Value
Added Training Program on “**KNOWLEDGE SHARING:
EMERGING TRENDS IN IT INDUSTRY**” organized by
Department of Computer Science and Engineering in
K.S.R.College of Engineering held from 20th to 24th July,2022.



M. Vallabhan
Co-ordinator

[Signature]
HoD

[Signature]
Principal
K.S.R. COLLEGE OF ENGINEERING
K.S.R. KALVI NAGAR,
TIRUCHENGODE-637 216



K.S.R.

COLLEGE OF ENGINEERING

[Autonomous]

TIRUCHENGODE-637215.
TAMILNADU, INDIA.



Department of Computer Science and Engineering

Certificate of Participation

This is to certify that Mr./Ms. SATHISH. J.

of K.S.R.COLLEGE OF ENGINEERING participated in Value Added Training Program on “**KNOWLEDGE SHARING: EMERGING TRENDS IN IT INDUSTRY**” organized by Department of Computer Science and Engineering in K.S.R.College of Engineering held from 20th to 24th July, 2022.



Manjula
Co-ordinator

[Signature]
HoD

[Signature]
Principal
K.S.R. COLLEGE OF ENGINEERING
K.S.R. KALVI NAGAR,
TIRUCHENGODE-637 215



K.S.R.

COLLEGE OF ENGINEERING

[Autonomous]

TIRUCHENGODE-637216.
TAMILNADU, INDIA.



Department of Computer Science and Engineering

Certificate of Participation

This is to certify that Mr./Ms. DHIVYA M.S

of K.S.R.COLLEGE OF ENGINEERING participated in Value Added Training Program on “**KNOWLEDGE SHARING: EMERGING TRENDS IN IT INDUSTRY**” organized by Department of Computer Science and Engineering in K.S.R.College of Engineering held from 20th to 24th July,2022.



Co-ordinator

HoD

Principal
K.S.R. COLLEGE OF ENGINEERING
K.S.R. KALVI NAGAR,
TIRUCHENGODE-637 215

K.S.R. COLLEGE OF ENGINEERING: TIRUCHENGODE – 637 215
DEPARTMENT OF ELECTRICAL AND ELECTRONICS ENGINEERING

CHECK LIST FOR VALUE ADDED COURSE

Name of the Programme: Value Added course on "printed Circuit Board Design and Fabrication"

Type of Programme : Self Supported / Sponsored

Funding Agency & Amount (if Funded): -

Date of the Programme: 25th April 2022 to 28th April 2022

Name of the Coordinator(s): Dr. M. Ramasamy and Dr. M. Vijayakumar

Check list for the submission of documents for Value Added Course (VAC)

S.No.	Particular	Tick
1.	Approval/Permission Letter	Yes/No
2.	Circular	Yes/No
3.	Invitation, Acceptance and Thanks Letters	Yes/No
4.	Profile of the Resource Person	Yes/No
5.	Course Content with Course Outcome	Yes/No
6.	Course Fees Details	Yes/No
7.	Quotation (if applicable)	Yes/No
8.	List of Participants	Yes/No
9.	Attendance Sheet	Yes/No
10.	Sample Certificates	Yes/No
11.	Feedback of the Participants	Yes/No
12.	Expenditure Details	Yes/No
13.	Photographs of the Programme	Yes/No
14.	Course Materials (If Any)	Yes/No

M. Ramasamy
15/04/2022
Coordinator



[Signature]
PRINCIPAL

K.S.R. COLLEGE OF ENGINEERING
K.S.R. Kalvi Nagar, Tiruchengode-637 215
Namakkal Dist., Tamilnadu

[Signature]
15/4/22
HoD/EEE

From

Dr.M.Ramasamy,
Associate Professor / EEE,
K.S.R. College of Engineering,
Tiruchengode - 637215.

To

The Principal,
K.S.R. College of Engineering,
K.S.R. Kalvi Nagar,
Tiruchengode – 637215.

Sir,

Sub.: Requisition to grant the Permission to Conduct a Value Added Course on Printed Circuit Board Design and Fabrication – Reg.,

The department of EEE has planned to conduct a Value Added Course on "Printed Circuit Board Design and Fabrication" to third year students during 05.04.2022 to 08.04.2022. Kindly grant the permission to conduct the above said course in our college premises during the above said period.

Course Schedule:

Duration of the Course	: 05.04.2022 to 08.04.2022 (04 Days)
No. of Hours	: 32 Hours (8 Hrs/Day)
Course Fees	: 800 / Students
Total Number of Students	: 24
Venue	: Electronics Laboratory

Resource Person: Mr.T.Anand, Innospace Automation Services Private Limited,
Chennai – 600083.

Faculty In-charge: 1. Dr.M.Ramasamy, ASP/EEE 2. Dr.M.Vijayakumar, AP/EEE

Thanking You

Yours Faithfully,

Dr.M.Ramasamy
01/04/2022
(Dr.M.Ramasamy)

Dr.M.Ramasamy
PRINCIPAL
K.S.R.COLLEGE OF ENGINEERING
K.S.R.Kalvi Nagar, Tiruchengode-637 215
Namakkal Dist., Tamilnadu



K.S.R.COLLEGE OF ENGINEERING: TIRUCHENGODE - 637 215
DEPARTMENT OF ELECTRICAL AND ELECTRONICS ENGINEERING
(Autonomous)

Date: 04-04-2022

Time: 09.30 a.m.

CIRCULAR

Classification	√ ROUTINE	IMMEDIATE
ORIGINATOR: HoD / EEE		CIRCULATED TO: III EEE & Faculty Concern

Sub.: Conduction of Value Added Course on "Printed Circuit Board Design and Fabrication" – Reg.,

The department of Electrical and Electronics Engineering has planned to conduct a Value Added Course on "Printed Circuit Board Design and Fabrication" to Third Year EEE students during 05th April 2022 to 08th April 2022. In connection with this, the regular classes for the following registered candidates are cancelled and the faculty members are asked to mark their absents as on duty/permission.

List of Students Registered

S. No.	Reg. No.	Name of the Student
1.	1914009	GOWTHAM V
2.	1914010	HARI GOKUL S
3.	1914011	HARI VIGNESH S
4.	1914012	HEMNATH V
5.	1914013	INFANTJENIFER R
6.	1914014	JANANI S
7.	1914015	JEEVANANDHAM S
8.	1914016	JEEVITHA G
9.	1914019	KARMUKILAN S
10.	1914020	KAVIN C
11.	1914022	KEERTHINATHAN R
12.	1914024	KISHORE S

S. No.	Reg. No.	Name of the Student
13.	1914029	NALAN R
14.	1914030	NAVEEN A
15.	1914031	NAVEEN KUMAR P
16.	1914032	PERUMAL D
17.	1914035	PREM PRAKASH S
18.	1914036	RANJITHKUMAR R
19.	1914042	SOMESHKANNAN V
20.	1914043	SRIDHAR A
21.	1914044	SUBASH G
22.	1914046	SURYAPRAKASH S
23.	1914503	GOWRIT T
24.	1914504	GUNA M

Handwritten signature
 Course Coordinator



Handwritten signature
 PRINCIPAL

K.S.R.COLLEGE OF ENGINEERING
 K.S.R. Kalvi Nagar, Tiruchengode-637 215
 Namakkal Dist., Tamilnadu

Handwritten signature
 HoD/EEE



K.S.R. COLLEGE OF ENGINEERING

(An Autonomous Institution, Approved by AICTE, New Delhi, Affiliated to Anna University, Chennai,
Accredited by NAAC with 'A' Grade and ISO 9001:2008 Certified Institution)

R. SRINIVASAN B.B.M.,

Chairman cum Managing Trustee

Dr. P. SENTHIL KUMAR M.E., Ph.D., (IITM)

Principal

Date: 30.03.2022

To

Mr.T.Anand

Training Engineer,

Innospace Automation Services Private Limited,

Chennai – 600083.

Dear Sir,

Sub.: Special Guest Invitation for the Value Added Course Titled "Printed Circuit Board Design and Fabrication" – Reg.,

The department of Electrical and Electronics Engineering has planned to organize a Value Added Course on "**Printed Circuit Board Design and Fabrication**" during **05th April 2022 to 08th April 2022** for the Third Year Students of our branch. In this regard, we have an immense pleasure to invite you to the above said value added course. I am eagerly expecting your acceptance at the earliest.

Thanking You.

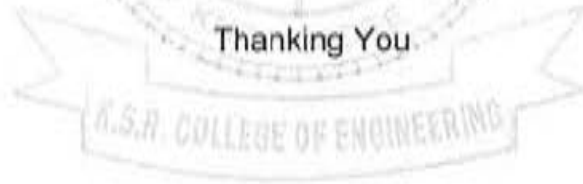

PRINCIPAL

PRINCIPAL
K.S.R. COLLEGE OF ENGINEERING
K.S.R. KALVI NAGAR,
TIRUCHENGODE-637 215.





K.S.R. COLLEGE OF ENGINEERING

(An Autonomous Institution, Approved by AICTE, New Delhi, Affiliated to Anna University, Chennai,
Accredited by NAAC with 'A' Grade and ISO 9001:2008 Certified Institution)

R. SRINIVASAN B.B.M.,
Chairman cum Managing Trustee

Dr. P. SENTHIL KUMAR M.E., Ph.D.,(ITM)
Principal

Date: 08.04.2022

To

Mr.T.Anand,
Training Engineer,
Innospace Automation Services Private Limited,
Chennai – 600083.

Sir,

Sub.: Letter of Appreciation – Reg.,

We glad to thank you very much for delivering an informative and thought providing lecture in the Value Added Course Titled “**Printed Circuit Board Design and Fabrication**” jointly organised by the Department of Electrical and Electronics Engineering and Innospace Automation Services Private Limited, Chennai - 600083 conducted during **05th April 2022 to 08th April 2022**. We are looking forward for your cooperation for the promotion of professional education in future as well.

Thank You

K.S.R. COLLEGE OF ENGINEERING

PRINCIPAL

PRINCIPAL
K.S.R. COLLEGE OF ENGINEERING
K.S.R. KALVI NAGAR,
TIRUCHENGODE-637 215



ANAND T

PERSONAL DETAILS

Name : Anand T
Date of birth : 15.12.1990
Address : 2/17B, Vairam Street,
Municipal colony,
Erode – 638004.
Mobile : 9790928992
E-mail : Richianand1990@gmail.com
LinkedIn : linkedin.com/in/anand-kumar-280522141

PROFILE

I'm an efficient Candidate, who has been consistently praised as hard-working by my co-worker and management. Highly flexible in adjusting work pace to meet evolving client needs. I am enthusiastic and I work with decisiveness. Overall, I have consistently demonstrated creative thinking and teamwork abilities.

SUMMARY OF SKILLS

- Good experience in C, Python programming.
- Good knowledge in designing Hardware Circuits and PCB.
- Proficient in Arduino, Tina, Eagle CAD, Google Sketch Up.
- Good Knowledge in ARM Cortex M4, AVR, 8051, PIC.
- Basic Knowledge in Neural Network, Machine learning.
- Good Knowledge in Python Flask, Flask MQTT, Threads, Paho MQTT, Sockets, Matplotlib.
- Proficient in NetBeans, Android Studio.
- Good Experience in EEPROM, ADC, DAC, Interrupts, SPI, I2C and UART serial interface.
- Developed admin panel with HTML, CSS, JQuery, AJAX and MySQL using Flask.

INTERESTS & EXTRA INFORMATION

13/10/16 – 15/10/16 **PCB Design Workshop**
Conducted workshop on PCB Board Making for 30 Students.

- Using Eagle CAD, PCB layouts were designed.
- With Photo-Resist Method, PCB-boards were made.

01/2017 – 03/2017 **Home Automation**
Converted my Home into smart home with my Mapping Technique

- Collect the data from the Nodes and Stores the data in server database.
- AJAX is used to get Synchronize data, which Node sends.
- Android application was created and the URL is called by Asyn Task
- Stand alone application was created with Java FX for the User Interface.



PRINCIPAL
K.S.R. COLLEGE OF ENGINEERING
K.S.R. Kalvi Nagar, Tiruchengode-637 215
Namakkal Dist., Tamilnadu

EDUCATION

- 2015 – 2017 **Master of Engineering**
KSR College of Engineering, Tiruchengode.
- Power Electronics and Drives.
 - Graduate with **86%**.
- 2008 – 2012 **Bachelor of Engineering**
Hindustan University, Chennai.
- Electrical and Electronics Engineering
 - Graduate with **59.9%**.
- 2005 – 2008 **Schooling**
Vedhha Vikass Higher Secondary School, Salem.
- State board
 - Graduate with **77.8%** in 12th and **71.2%** in 10th

ACADEMIC PROJECT

- 01/2013 – 04/2015 **Uninterrupted power supply using Arduino with remote control**
Developed a remote control system to operate the UPS remotely
- Fans lights were controlled remotely which is connected to the UPS.
 - Designed Inverter with unipolar PWM switching.
- 07/2016 – 05/2017 **Automated Node Network Interface using CoAP with NRF24I01**
Converted Home into smart home using CoAP
- Nodes were connected automatically through Wireless Transceiver.
 - User can easily access his/her home using Mobile/Laptop/Tablet via CoAP.

COURSE COMPLETED

- 02/07/12 – 19/08/12 **PCB Design Course**
Successfully completed PCB Design Course in Sienna ECAD, Bangalore.
- Cadence Allegro was used to design the PCB Layout.
 - Designed up to 4 layers Layout Board.
 - Components were created in the library for different Packages.
- 01/03/13 – 30/03/13 **AutoCAD 2D**
Successfully completed AutoCAD Course in CADD center, Dharmapuri.
- Designed BLDC motor using Reverse Engineering Technique.
 - Designed Electrical Panel Board for Textile Industry.

ANAND T



PRINCIPAL

K.S.R. COLLEGE OF ENGINEERING Page 3 of 3
K.S.R. Kalvi Nagar, Tiruchengode-637 215
Namakkal Dist., Tamilnadu

K.S.R. COLLEGE OF ENGINEERING, TIRUCHENGODE – 637 215

(An Autonomous Institution, Affiliated to Anna University, Chennai & Accredited by NAAC with 'A' Grade)

DEPARTMENT OF ELECTRICAL AND ELECTRONICS ENGINEERING

Value Added Course (VAC)

On

"Printed Circuit Board Design and Fabrication"

05th April 2022 to 08th April 2022

Date: 12.04.2022

OUTCOME	Related POs and PSOs
<p>Course Outcomes:</p> <p>On Completion of this Course, the student will be able to</p> <ol style="list-style-type: none"> 1 Understand the necessity and evolution of PCB types. 2. Understand the steps involved in schematic layout, fabrication and assembly process of PCB design. 3 Apply advance techniques, skills and modern tools for designing and fabrication of PCBs. 4 Design (schematic and layout) PCB for analog circuits, digital circuits and mixed circuits. 5. Design (schematic and layout) and fabricate PCB for simple circuits. 	<p>PO1,PO2,PO3,PO4, PO5,PO6,PO7,PO9, PO12,PSO1,PSO2</p>

12/04/2022
Course Coordinator



PRINCIPAL

K.S.R.COLLEGE OF ENGINEERING
K.S.R.Kalvi Nagar, Tiruchengode-637 215
Namakkal Dist., Tamilnadu

12/04/2022
HoD/EEE

K.S.R. COLLEGE OF ENGINEERING (Autonomous): TIRUCHENGODE – 637 215
DEPARTMENT OF ELECTRICAL AND ELECTRONICS ENGINEERING



Value Added Course on
"Printed Circuit Board Design and Fabrication"
COURE FEES DETAILS

05th April 2022 to 08th April 2022

S. No.	Reg. No.	Name of the Student	Course Fees in Rs.	Signature
1.	1914009	GOWTHAM V	800	Gowtham V.
2.	1914010	HARI GOKUL S	800	S. Hari
3.	1914011	HARI VIGNESH S	800	S. Hari
4.	1914012	HEMNATH V	800	Hemnath V.
5.	1914013	INFANTJENIFER R	800	R. Jennifer
6.	1914014	JANANI S	800	S. Janani
7.	1914015	JEEVANANDHAM S	800	S. Jeevanandham
8.	1914016	JEEVITHA G	800	G. Jeevitha
9.	1914019	KARMUKILAN S	800	S. Karmukilan
10.	1914020	KAVIN C	800	Kavin C.
11.	1914022	KEERTHINATHAN R	800	R. Keerthi
12.	1914024	KISHORE S	800	S. Kishore
13.	1914029	NALAN R	800	R. Nalan
14.	1914030	NAVEEN A	800	A. Naveen
15.	1914031	NAVEEN KUMAR P	800	P. Naveen
16.	1914032	PERUMAL D	800	D. Perumal
17.	1914035	PREM PRAKASH S	800	S. Prem
18.	1914036	RANJITHKUMAR R	800	R. Ranjith Kumar
19.	1914042	SOMESHKANNAN V	800	V. Someshkannan
20.	1914043	SRIDHAR A	800	A. Sridhar
21.	1914044	SUBASH G	800	G. Subash
22.	1914046	SURYAPRAKASH S	800	S. Suryaprakash
23.	1914503	GOWRIT T	800	T. Gowrit
24.	1914504	GUNA M	800	M. Guna
Total Amount in Rs.			19200/-	

Prasanna
 01/04/2022
 Course Coordinator



[Signature]

PRINCIPAL

K.S.R. COLLEGE OF ENGINEERING
 K.S.R. Kalvi Nagar, Tiruchengode-637 215
 Namakkal Dist., Tamilnadu

[Signature]
 HoD/EEE

K.S.R. COLLEGE OF ENGINEERING (Autonomous): TIRUCHENGODE – 637 215

DEPARTMENT OF ELECTRICAL AND ELECTRONICS ENGINEERING



Value Added Course on

"Printed Circuit Board Design and Fabrication"

05th April 2022 to 08th April 2022

LIST OF PARTICIPANTS

S. No.	Reg. No.	Name of the Student
1.	1914009	GOWTHAM V
2.	1914010	HARI GOKUL S
3.	1914011	HARI VIGNESH S
4.	1914012	HEMNATH V
5.	1914013	INFANTJENIFER R
6.	1914014	JANANI S
7.	1914015	JEEVANANDHAM S
8.	1914016	JEEVITHA G
9.	1914019	KARMUKILAN S
10.	1914020	KAVIN C
11.	1914022	KEERTHINATHAN R
12.	1914024	KISHORE S
13.	1914029	NALAN R
14.	1914030	NAVEEN A
15.	1914031	NAVEEN KUMAR P
16.	1914032	PERUMAL D
17.	1914035	PREM PRAKASH S
18.	1914036	RANJITHKUMAR R
19.	1914042	SOMESHKANNAN V
20.	1914043	SRIDHAR A
21.	1914044	SUBASH G
22.	1914046	SURYAPRAKASH S
23.	1914503	GOWRIT T
24.	1914504	GUNA M

Principals
01/04/2022
Course Coordinator



[Handwritten Signature]

PRINCIPAL

K.S.R. COLLEGE OF ENGINEERING
K.S.R. Kalvi Nagar, Tiruchengode-637 215
Namakkal Dist., Tamilnadu

[Handwritten Signature]
HoD/EEE

K.S.R. COLLEGE OF ENGINEERING: TIRUCHENGODE – 637 215
DEPARTMENT OF ELECTRICAL AND ELECTRONICS ENGINEERING
Value Added Course on "Printed Circuit Board Design and Fabrication"
05th April 2022 to 08th April 2022

S. No.	Reg. No.	Name of the Student	05.04.2022		06.04.2022		07.04.2022		08.04.2022	
			FN	AN	FN	AN	FN	AN	FN	AN
1.	1914009	GOWTHAM V	Gowtham	Gowtham	Gowtham	Gowtham	Gowtham	Gowtham	Gowtham	Gowtham
2.	1914010	HARI GOKUL S	S. Hari	S. Hari	S. Hari	S. Hari	S. Hari	S. Hari	S. Hari	S. Hari
3.	1914011	HARI VIGNESH S	S. Hari	S. Hari	S. Hari	S. Hari	S. Hari	S. Hari	S. Hari	S. Hari
4.	1914012	HEMNATH V	Hemnath	Hemnath	Hemnath	Hemnath	Hemnath	Hemnath	Hemnath	Hemnath
5.	1914013	INFANTJENIFER R	R. Infant	R. Infant	R. Infant	R. Infant	R. Infant	R. Infant	R. Infant	R. Infant
6.	1914014	JANANI S	S. Janani	S. Janani	S. Janani	S. Janani	S. Janani	S. Janani	S. Janani	S. Janani
7.	1914015	JEEVANANDHAM S	S. Jeevan	S. Jeevan	S. Jeevan	S. Jeevan	S. Jeevan	S. Jeevan	S. Jeevan	S. Jeevan
8.	1914016	JEEVITHA G	G. Jeevitha	G. Jeevitha	G. Jeevitha	G. Jeevitha	G. Jeevitha	G. Jeevitha	G. Jeevitha	G. Jeevitha
9.	1914019	KARMUKILAN S	S. Karmu	S. Karmu	S. Karmu	S. Karmu	S. Karmu	S. Karmu	S. Karmu	S. Karmu
10.	1914020	KAVIN C	C. Kavitha	C. Kavitha	C. Kavitha	C. Kavitha	C. Kavitha	C. Kavitha	C. Kavitha	C. Kavitha
11.	1914022	KEERTHINATHAN R	R. Keerthi	R. Keerthi	R. Keerthi	R. Keerthi	R. Keerthi	R. Keerthi	R. Keerthi	R. Keerthi
12.	1914024	KISHORE S	S. Kishore	S. Kishore	S. Kishore	S. Kishore	S. Kishore	S. Kishore	S. Kishore	S. Kishore
13.	1914029	NALAN R	R. Nalan	R. Nalan	R. Nalan	R. Nalan	R. Nalan	R. Nalan	R. Nalan	R. Nalan
14.	1914030	NAVEEN A	A. Naveen	A. Naveen	A. Naveen	A. Naveen	A. Naveen	A. Naveen	A. Naveen	A. Naveen
15.	1914031	NAVEEN KUMAR P	P. Naveen	P. Naveen	P. Naveen	P. Naveen	P. Naveen	P. Naveen	P. Naveen	P. Naveen
16.	1914032	PERUMAL D	D. Perumal	D. Perumal	D. Perumal	D. Perumal	D. Perumal	D. Perumal	D. Perumal	D. Perumal
17.	1914035	PREM PRAKASH S	S. Prem	S. Prem	S. Prem	S. Prem	S. Prem	S. Prem	S. Prem	S. Prem
18.	1914036	RANJITHKUMAR R	R. Ranjith	R. Ranjith	R. Ranjith	R. Ranjith	R. Ranjith	R. Ranjith	R. Ranjith	R. Ranjith
19.	1914042	SOMESHKANNAN V	V. Somesh	V. Somesh	V. Somesh	V. Somesh	V. Somesh	V. Somesh	V. Somesh	V. Somesh
20.	1914043	SRIDHAR A	A. Sridhar	A. Sridhar	A. Sridhar	A. Sridhar	A. Sridhar	A. Sridhar	A. Sridhar	A. Sridhar
21.	1914044	SUBASH G	G. Subash	G. Subash	G. Subash	G. Subash	G. Subash	G. Subash	G. Subash	G. Subash
22.	1914046	SURYAPRAKASH S	S. Surya	S. Surya	S. Surya	S. Surya	S. Surya	S. Surya	S. Surya	S. Surya
23.	1914503	GOWRIT T	T. Gowrit	T. Gowrit	T. Gowrit	T. Gowrit	T. Gowrit	T. Gowrit	T. Gowrit	T. Gowrit
24.	1914504	GUNA M	M. Guna	M. Guna	M. Guna	M. Guna	M. Guna	M. Guna	M. Guna	M. Guna

Course Coordinator



HoD/EEE

PRINCIPAL

 K.S.R. COLLEGE OF ENGINEERING
 K.S.R. Kalvi Nagar, Tiruchengode-637 215
 Namakkal Dist., Tamilnadu

K.S.R. COLLEGE OF ENGINEERING

(Autonomous)

TIRUCHENGODE-637215



Certificate of Participation

This to certify that **S. HARI GOKUL**, Department of Electrical and Electronics Engineering, K.S.R. College of Engineering has attended a Value Added Course on **“Printed Circuit Board Design and Fabrication”** jointly organized by the Department of EEE, K.S.R. College of Engineering and Innospace Automation Services Private Limited, Chennai during 05.04.2022 to 08.04.2022.

Dr.M.Ramasamy
Coordinator

K.S.R. College of Engineering
Tiruchengode



PRINCIPAL
K.S.R.COLLEGE OF ENGINEERING

K.S.R. Kalvi Nagar, Tiruchengode-637 215
Namakkal Dist., Tamil Nadu

T.Anand
Training Engineer

Innospace Automation Services Private Limited
Chennai

K.S.R. COLLEGE OF ENGINEERING

(Autonomous)

TIRUCHENGODE-637215



Certificate of Participation

This to certify that **S. HARI VIGNESH**, Department of Electrical and Electronics Engineering, K.S.R. College of Engineering has attended a Value Added Course on **“Printed Circuit Board Design and Fabrication”** jointly organized by the Department of EEE, K.S.R. College of Engineering and Innospace Automation Services Private Limited, Chennai during 05.04.2022 to 08.04.2022.

Dr.M.Ramasamy

Coordinator

K.S.R. College of Engineering
Tiruchengode



PRINCIPAL

K.S.R. COLLEGE OF ENGINEERING,
K.S.R. Kalvi Nagar, Tiruchengode-637 215
Namakkal Dist., Tamilnadu

T.Anand

Training Engineer

Innospace Automation Services Private Limited
Chennai

K.S.R. COLLEGE OF ENGINEERING

(Autonomous)

TIRUCHENGODE-637215



Certificate of Participation

This to certify that **V. HEMNATH**, Department of Electrical and Electronics Engineering, K.S.R. College of Engineering has attended a Value Added Course on **“Printed Circuit Board Design and Fabrication”** jointly organized by the Department of EEE, K.S.R. College of Engineering and Innospace Automation Services Private Limited, Chennai during 05.04.2022 to 08.04.2022.

Dr.M.Ramasamy
Coordinator
K.S.R. College of Engineering
Tiruchengode



PRINCIPAL
K.S.R. COLLEGE OF ENGINEERING
K.S.R. Kalvi Nagar, Tiruchengode-637 215
Namakkal Dist. Tamilnadu

T.Anand
Training Engineer
Innospace Automation Services Private Limited
Chennai



K.S.R. COLLEGE OF ENGINEERING

(Autonomous)

TIRUCHENGODE-637215



Certificate of Participation

This to certify that **R. INFANT JENIFER**, Department of Electrical and Electronics Engineering, K.S.R. College of Engineering has attended a Value Added Course on **“Printed Circuit Board Design and Fabrication”** jointly organized by the Department of EEE, K.S.R. College of Engineering and Innospace Automation Services Private Limited, Chennai during 05.04.2022 to 08.04.2022.

Dr.M.Ramasamy

Coordinator

K.S.R. College of Engineering
Tiruchengode



PRINCIPAL

K.S.R.COLLEGE OF ENGINEERING
K.S.R.Kalvi Nagar, Tiruchengode-637 215
Namakkal Dist., Tamilnadu

T.Anand

Training Engineer

Innospace Automation Services Private Limited
Chennai

K.S.R. COLLEGE OF ENGINEERING

(Autonomous)

TIRUCHENGODE-637215



Certificate of Participation

This to certify that **R. NALAN**, Department of Electrical and Electronics Engineering, K.S.R. College of Engineering has attended a Value Added Course on “**Printed Circuit Board Design and Fabrication**” jointly organized by the Department of EEE, K.S.R. College of Engineering and Innospace Automation Services Private Limited, Chennai during 05.04.2022 to 08.04.2022.

Dr.M.Ramasamy
Coordinator

K.S.R. College of Engineering
Tiruchengode



PRINCIPAL
K.S.R.COLLEGE OF ENGINEERING
K.S.R.Kalvi Nagar, Tiruchengode-637 215
Namakkal Dist., Tamilnadu

T.Anand
Training Engineer

Innospace Automation Services Private Limited
Chennai

K.S.R. COLLEGE OF ENGINEERING

(Autonomous)

TIRUCHENGODE-637215



Certificate of Participation

This to certify that **V. GOWTHAM**, Department of Electrical and Electronics Engineering, K.S.R. College of Engineering has attended a Value Added Course on “**Printed Circuit Board Design and Fabrication**” jointly organized by the Department of EEE, K.S.R. College of Engineering and Innospace Automation Services Private Limited, Chennai during 05.04.2022 to 08.04.2022.

Dr.M.Ramasamy
Coordinator

K.S.R. College of Engineering
Tiruchengode



PRINCIPAL
K.S.R. COLLEGE OF ENGINEERING
K.S.R. Kalvi Nagar, Tiruchengode-637 215
Namakkal Dist., Tamilnadu

T.Anand
Training Engineer

Innospace Automation Services Private Limited
Chennai

K.S.R. COLLEGE OF ENGINEERING, TIRUCHENGODE – 637 215

(An Autonomous Institution, Affiliated to Anna University, Chennai & Accredited by NAAC with 'A' Grade)

DEPARTMENT OF ELECTRICAL AND ELECTRONICS ENGINEERING**Value Added Course (VAC)**

On

**“Printed Circuit Board Design and Fabrication”**05th April 2022 to 08th April 2022**FEEDBACK ANALYSIS**

sl.no	Parameters	Excellent	Good	Satisfactory	Poor
1	Have you understood the concepts PCB Design?	10	13	1	-
2	Are you satisfied with the components that could be used for PCB Design?	5	15	4	-
3	Are you familiar with programming concepts of PCB Design?	10	11	3	-
4	Have you got enough idea about PCB design Process?	7	14	3	-
5	What is your opinion about the industry person content delivery and time management?	7	15	2	-
6	Did the Course cover what you were expecting?	8	10	6	-
7	Have you recommend the course in future?	21(yes)	3(No)	-	-
Total		68	81	19	-
		40.47%	48.21%	11.30%	-

Prasanna
11/04/2022
Course Coordinator



[Signature]
PRINCIPAL
K.S.R. COLLEGE OF ENGINEERING
K.S.R. Kalai Nagar, Tiruchengode-637 215
Namakkal Dist., Tamilnadu

[Signature]
HoD/EEE

K.S.R. COLLEGE OF ENGINEERING, TIRUCHENGODE – 637 215

(An Autonomous Institution, Affiliated to Anna University, Chennai & Accredited by NAAC with 'A' Grade)

DEPARTMENT OF ELECTRICAL AND ELECTRONICS ENGINEERING

Value Added Course (VAC)

On

"Printed Circuit Board Design and Fabrication"

05th April 2022 to 08th April 2022

Date: 08.04.2022



FEEDBACK FORM

1. Have you understood the concepts PCB Design?
 a) Excellent b) Good c) Satisfactory d) Poor
2. Are you satisfied with the components that could be used for PCB Design?
 a) Excellent b) Good c) Satisfactory d) Poor
3. Are you familiar with programming concepts of PCB Design?
 a) Excellent b) Good c) Satisfactory d) Poor
4. Have you got enough idea about PCB design Process?
 a) Excellent b) Good c) Satisfactory d) Poor
5. What is your opinion about the industry person content delivery and time management?
 a) Excellent b) Good c) Satisfactory d) Poor
6. Did the Course cover what you were expecting?
 a) Excellent b) Good c) Satisfactory d) Poor
7. Have you recommend the course in future?
 a) Yes b) No

Suggestions if any: NIL



[Handwritten Signature]
PRINCIPAL
 K.S.R. COLLEGE OF ENGINEERING
 K.S.R. Kalvi Nagar, Tiruchengode-637 215
 Namakkal Dist., Tamilnadu

[Handwritten Signature] / 22
Signature of the student with date

K.S.R. COLLEGE OF ENGINEERING, TIRUCHENGODE – 637 215

(An Autonomous Institution, Affiliated to Anna University, Chennai & Accredited by NAAC with 'A' Grade)

DEPARTMENT OF ELECTRICAL AND ELECTRONICS ENGINEERING

Value Added Course (VAC)

On

"Printed Circuit Board Design and Fabrication"

05th April 2022 to 08th April 2022

Date: 08.04.2022



FEEDBACK FORM

1. Have you understood the concepts PCB Design?
 a) Excellent b) Good c) Satisfactory d) Poor
2. Are you satisfied with the components that could be used for PCB Design?
 a) Excellent b) Good c) Satisfactory d) Poor
3. Are you familiar with programming concepts of PCB Design?
 a) Excellent b) Good c) Satisfactory d) Poor
4. Have you got enough idea about PCB design Process?
 a) Excellent b) Good c) Satisfactory d) Poor
5. What is your opinion about the industry person content delivery and time management?
 a) Excellent b) Good c) Satisfactory d) Poor
6. Did the Course cover what you were expecting?
 a) Excellent b) Good c) Satisfactory d) Poor
7. Have you recommend the course in future?
 a) Yes b) No

Suggestions if any:



[Handwritten signature in green ink]

PRINCIPAL
K.S.R.COLLEGE OF ENGINEERING
K.S.R.Kalvi Nagar, Tiruchengode-637 215
Namakkal Dist., Tamilnadu

[Handwritten signature in blue ink]
P. Noorjahan 8/4/2022

Signature of the student with date

K.S.R. COLLEGE OF ENGINEERING, TIRUCHENGODE – 637 215

(An Autonomous Institution, Affiliated to Anna University, Chennai & Accredited by NAAC with 'A' Grade)

DEPARTMENT OF ELECTRICAL AND ELECTRONICS ENGINEERING

Value Added Course (VAC)

On

"Printed Circuit Board Design and Fabrication"

05th April 2022 to 08th April 2022

Date: 08.04.2022





FEEDBACK FORM

1. Have you understood the concepts PCB Design?
 a) Excellent b) Good c) Satisfactory d) Poor
2. Are you satisfied with the components that could be used for PCB Design?
 a) Excellent b) Good c) Satisfactory d) Poor
3. Are you familiar with programming concepts of PCB Design?
 a) Excellent b) Good c) Satisfactory d) Poor
4. Have you got enough idea about PCB design Process?
 a) Excellent b) Good c) Satisfactory d) Poor
5. What is your opinion about the industry person content delivery and time management?
 a) Excellent b) Good c) Satisfactory d) Poor
6. Did the Course cover what you were expecting?
 a) Excellent b) Good c) Satisfactory d) Poor
7. Have you recommend the course in future?
 a) Yes b) No

Suggestions if any:



PRINCIPAL
 K.S.R. COLLEGE OF ENGINEERING
 K.S.R. Kalvi Nagar, Tiruchengode-637 215
 Namekkal Dist., Tamilnadu

Signature of the student with date

KSRCE/IQAC/2021-2022/EEE/IC4-64

K.S.R. COLLEGE OF ENGINEERING, TIRUCHENGODE – 637 215**(An Autonomous Institution, Affiliated to Anna University, Chennai & Accredited by NAAC with 'A' Grade)****DEPARTMENT OF ELECTRICAL AND ELECTRONICS ENGINEERING****Value Added Course (VAC)****On****"Printed Circuit Board Design and Fabrication"****05th April 2022 to 08th April 2022****Date: 08.04.2022****FEEDBACK FORM**

1. Have you understood the concepts PCB Design?
a) Excellent b) Good c) Satisfactory d) Poor
2. Are you satisfied with the components that could be used for PCB Design?
a) Excellent b) Good c) Satisfactory d) Poor
3. Are you familiar with programming concepts of PCB Design?
a) Excellent b) Good c) Satisfactory d) Poor
4. Have you got enough idea about PCB design Process?
a) Excellent b) Good c) Satisfactory d) Poor
5. What is your opinion about the industry person content delivery and time management?
a) Excellent b) Good c) Satisfactory d) Poor
6. Did the Course cover what you were expecting?
a) Excellent b) Good c) Satisfactory d) Poor
7. Have you recommend the course in future?
a) Yes b) No

Suggestions if any:
Signature of the student with date

PRINCIPAL
K.S.R. COLLEGE OF ENGINEERING
K.S.R. Kalvi Nagar, Tiruchengode-637 215
Namakkal Dist., Tamilnadu

KSRCE/IQAC/2021-2022/EEE/IC4-64

K.S.R. COLLEGE OF ENGINEERING, TIRUCHENGODE – 637 215**(An Autonomous Institution, Affiliated to Anna University, Chennai & Accredited by NAAC with 'A' Grade)****DEPARTMENT OF ELECTRICAL AND ELECTRONICS ENGINEERING****Value Added Course (VAC)****On****"Printed Circuit Board Design and Fabrication"****05th April 2022 to 08th April 2022****Date: 08.04.2022****FEEDBACK FORM**

1. Have you understood the concepts PCB Design?
a) Excellent b) Good c) Satisfactory d) Poor
2. Are you satisfied with the components that could be used for PCB Design?
a) Excellent b) Good c) Satisfactory d) Poor
3. Are you familiar with programming concepts of PCB Design?
a) Excellent b) Good c) Satisfactory d) Poor
4. Have you got enough idea about PCB design Process?
a) Excellent b) Good c) Satisfactory d) Poor
5. What is your opinion about the industry person content delivery and time management?
a) Excellent b) Good c) Satisfactory d) Poor
6. Did the Course cover what you were expecting?
a) Excellent b) Good c) Satisfactory d) Poor
7. Have you recommend the course in future?
a) Yes b) No

Suggestions if any:

R. K. S. / 8/4/22
Signature of the student with date

PRINCIPAL
K.S.R. COLLEGE OF ENGINEERING
K.S.R. Kalvi Nagar, Tiruchengode-637 215
Namakkal Dist., Tamilnadu

KSRCE/IQAC/2021-2022/EEE/IC4-64

K.S.R. COLLEGE OF ENGINEERING, TIRUCHENGODE – 637 215

(An Autonomous Institution, Affiliated to Anna University, Chennai & Accredited by NAAC with 'A' Grade)

DEPARTMENT OF ELECTRICAL AND ELECTRONICS ENGINEERING

Value Added Course (VAC)

On

"Printed Circuit Board Design and Fabrication"

05th April 2022 to 08th April 2022

Date: 08.04.2022

FEEDBACK FORM

1. Have you understood the concepts PCB Design?
a) Excellent b) ~~Good~~ c) Satisfactory d) Poor
2. Are you satisfied with the components that could be used for PCB Design?
a) ~~Excellent~~ b) Good c) Satisfactory d) Poor
3. Are you familiar with programming concepts of PCB Design?
a) Excellent b) ~~Good~~ c) Satisfactory d) Poor
4. Have you got enough idea about PCB design Process?
a) ~~Excellent~~ b) Good c) Satisfactory d) Poor
5. What is your opinion about the industry person content delivery and time management?
a) Excellent b) ~~Good~~ c) Satisfactory d) Poor
6. Did the Course cover what you were expecting?
a) ~~Excellent~~ b) Good c) Satisfactory d) Poor
7. Have you recommend the course in future?
a) ~~Yes~~ b) No

Suggestions if any:



Signature of the student with date

PRINCIPAL
K.S.R. COLLEGE OF ENGINEERING
K.S.R. Kalvi Nagar, Tiruchengode-637 215
Namakkal Dist., Tamilnadu

KSRCE/IQAC/2021-2022/EEE/IC4-64

K.S.R. COLLEGE OF ENGINEERING, TIRUCHENGODE – 637 215**(An Autonomous Institution, Affiliated to Anna University, Chennai & Accredited by NAAC with 'A' Grade)****DEPARTMENT OF ELECTRICAL AND ELECTRONICS ENGINEERING****Value Added Course (VAC)****On****"Printed Circuit Board Design and Fabrication"****05th April 2022 to 08th April 2022****Date: 08.04.2022****FEEDBACK FORM**

1. Have you understood the concepts PCB Design?
 a) Excellent b) Good c) Satisfactory d) Poor
2. Are you satisfied with the components that could be used for PCB Design?
 a) Excellent b) Good c) Satisfactory d) Poor
3. Are you familiar with programming concepts of PCB Design?
 a) Excellent b) Good c) Satisfactory d) Poor
4. Have you got enough idea about PCB design Process?
 a) Excellent b) Good c) Satisfactory d) Poor
5. What is your opinion about the industry person content delivery and time management?
 a) Excellent b) Good c) Satisfactory d) Poor
6. Did the Course cover what you were expecting?
 a) Excellent b) Good c) Satisfactory d) Poor
7. Have you recommend the course in future?
 a) Yes b) No

Suggestions if any:
Signature of the student with date

PRINCIPAL
K.S.R. COLLEGE OF ENGINEERING
K.S.R. Kalvi Nagar, Tiruchengode-637 215
Namakkal Dist., Tamilnadu

A. Nowsen / 08/04/2022

K.S.R. COLLEGE OF ENGINEERING, TIRUCHENGODE – 637 215**(An Autonomous Institution, Affiliated to Anna University, Chennai & Accredited by NAAC with 'A' Grade)****DEPARTMENT OF ELECTRICAL AND ELECTRONICS ENGINEERING****Value Added Course (VAC)****On****"Printed Circuit Board Design and Fabrication"****05th April 2022 to 08th April 2022****Date: 08.04.2022****FEEDBACK FORM**

1. Have you understood the concepts PCB Design?
a) Excellent b) Good c) Satisfactory d) Poor
2. Are you satisfied with the components that could be used for PCB Design?
a) Excellent b) Good c) Satisfactory d) Poor
3. Are you familiar with programming concepts of PCB Design?
a) Excellent b) Good c) Satisfactory d) Poor
4. Have you got enough idea about PCB design Process?
a) Excellent b) Good c) Satisfactory d) Poor
5. What is your opinion about the industry person content delivery and time management?
a) Excellent b) Good c) Satisfactory d) Poor
6. Did the Course cover what you were expecting?
 a) Excellent b) Good c) Satisfactory d) Poor
7. Have you recommend the course in future?
 a) Yes b) No

Suggestions if any:

R. Ranjith Kumar
08.04.22.
Signature of the student with date

PRINCIPAL
K.S.R. COLLEGE OF ENGINEERING
K.S.R. Kalvi Nagar, Tiruchengode-637 215
Namakkal Dist., Tamilnadu

KSRCE/IQAC/2021-2022/EEE/IC4-64

K.S.R. COLLEGE OF ENGINEERING, TIRUCHENGODE – 637 215**(An Autonomous Institution, Affiliated to Anna University, Chennai & Accredited by NAAC with 'A' Grade)****DEPARTMENT OF ELECTRICAL AND ELECTRONICS ENGINEERING****Value Added Course (VAC)****On****"Printed Circuit Board Design and Fabrication"****05th April 2022 to 08th April 2022****Date: 08.04.2022****FEEDBACK FORM**

1. Have you understood the concepts PCB Design?
a) Excellent b) Good c) ~~Satisfactory~~ d) Poor
2. Are you satisfied with the components that could be used for PCB Design?
a) Excellent b) ~~Good~~ c) Satisfactory d) Poor
3. Are you familiar with programming concepts of PCB Design?
a) Excellent b) Good c) ~~Satisfactory~~ d) Poor
4. Have you got enough idea about PCB design Process?
a) Excellent b) ~~Good~~ c) Satisfactory d) Poor
5. What is your opinion about the industry person content delivery and time management?
a) Excellent b) ~~Good~~ c) Satisfactory d) Poor
6. Did the Course cover what you were expecting?
a) Excellent b) Good c) ~~Satisfactory~~ d) Poor
7. Have you recommend the course in future?
a) ~~Yes~~ b) No

Suggestions if any:

PRINCIPAL
K.S.R. COLLEGE OF ENGINEERING
K.S.R. Kalvi Nagar, Tiruchengode-637 215
Namakkal Dist., Tamilnadu

Signature of the student with date

[Handwritten Signature]
08/04/2022

K.S.R. COLLEGE OF ENGINEERING, TIRUCHENGODE – 637 215

(An Autonomous Institution, Affiliated to Anna University, Chennai & Accredited by NAAC with 'A' Grade)

DEPARTMENT OF ELECTRICAL AND ELECTRONICS ENGINEERING

Value Added Course (VAC)

On

"Printed Circuit Board Design and Fabrication"

05th April 2022 to 08th April 2022

Date: 08.04.2022

FEEDBACK FORM

1. Have you understood the concepts PCB Design?
a) Excellent b) Good c) Satisfactory d) Poor
2. Are you satisfied with the components that could be used for PCB Design?
a) Excellent b) Good c) Satisfactory d) Poor
3. Are you familiar with programming concepts of PCB Design?
a) Excellent b) Good c) Satisfactory d) Poor
4. Have you got enough idea about PCB design Process?
a) Excellent b) Good c) Satisfactory d) Poor
5. What is your opinion about the industry person content delivery and time management?
a) Excellent b) Good c) Satisfactory d) Poor
6. Did the Course cover what you were expecting?
a) Excellent b) Good c) Satisfactory d) Poor
7. Have you recommend the course in future?
 a) Yes b) No

Suggestions if any:



[Handwritten signature in green ink]

PRINCIPAL

**K.S.R. COLLEGE OF ENGINEERING
K.S.R. Kalvi Nagar, Tiruchengode-637 215
Namakkal Dist., Tamilnadu**

[Handwritten signature in black ink]
08/04/2022

Signature of the student with date

K.S.R. COLLEGE OF ENGINEERING, TIRUCHENGODE – 637 215

(An Autonomous Institution, Affiliated to Anna University, Chennai & Accredited by NAAC with 'A' Grade)

DEPARTMENT OF ELECTRICAL AND ELECTRONICS ENGINEERING

Value Added Course (VAC)

On

"Printed Circuit Board Design and Fabrication"

05th April 2022 to 08th April 2022

Date: 08.04.2022



FEEDBACK FORM

1. Have you understood the concepts PCB Design?
 a) Excellent b) Good c) Satisfactory d) Poor
2. Are you satisfied with the components that could be used for PCB Design?
 a) Excellent b) Good c) Satisfactory d) Poor
3. Are you familiar with programming concepts of PCB Design?
 a) Excellent b) Good c) Satisfactory d) Poor
4. Have you got enough idea about PCB design Process?
 a) Excellent b) Good c) Satisfactory d) Poor
5. What is your opinion about the industry person content delivery and time management?
 a) Excellent b) Good c) Satisfactory d) Poor
6. Did the Course cover what you were expecting?
 a) Excellent b) Good c) Satisfactory d) Poor
7. Have you recommend the course in future?
 a) Yes b) No

Suggestions if any:

PRINCIPAL
K.S.R.COLLEGE OF ENGINEERING
K.S.R.Kalvi Nagar, Tiruchengode-637 215
Namakkal Dist., Tamilnadu

Signature of the student with date

S. Sankar
8/4/22



KSRCE/IQAC/2021-2022/EEE/IC4-64

K.S.R. COLLEGE OF ENGINEERING, TIRUCHENGODE – 637 215**(An Autonomous Institution, Affiliated to Anna University, Chennai & Accredited by NAAC with 'A' Grade)****DEPARTMENT OF ELECTRICAL AND ELECTRONICS ENGINEERING****Value Added Course (VAC)****On****"Printed Circuit Board Design and Fabrication"****05th April 2022 to 08th April 2022****Date: 08.04.2022****FEEDBACK FORM**

1. Have you understood the concepts PCB Design?
 a) Excellent b) Good c) Satisfactory d) Poor
2. Are you satisfied with the components that could be used for PCB Design?
 a) Excellent b) Good c) Satisfactory d) Poor
3. Are you familiar with programming concepts of PCB Design?
 a) Excellent b) Good c) Satisfactory d) Poor
4. Have you got enough idea about PCB design Process?
 a) Excellent b) Good c) Satisfactory d) Poor
5. What is your opinion about the industry person content delivery and time management?
 a) Excellent b) Good c) Satisfactory d) Poor
6. Did the Course cover what you were expecting?
 a) Excellent b) Good c) Satisfactory d) Poor
7. Have you recommend the course in future?
 a) Yes b) No

Suggestions If any:
PRINCIPAL
K.S.R. COLLEGE OF ENGINEERING
K.S.R. Kalvi Nagar, Tiruchengode-637 215
Namakkal Dist., Tamilnadu
Signature of the student with date

8/4/22

K.S.R. COLLEGE OF ENGINEERING, TIRUCHENGODE – 637 215**(An Autonomous Institution, Affiliated to Anna University, Chennai & Accredited by NAAC with 'A' Grade)****DEPARTMENT OF ELECTRICAL AND ELECTRONICS ENGINEERING****Value Added Course (VAC)****On****"Printed Circuit Board Design and Fabrication"****05th April 2022 to 08th April 2022****Date: 08.04.2022****FEEDBACK FORM**

1. Have you understood the concepts PCB Design?
 a) Excellent b) Good c) Satisfactory d) Poor
2. Are you satisfied with the components that could be used for PCB Design?
 a) Excellent b) Good c) Satisfactory d) Poor
3. Are you familiar with programming concepts of PCB Design?
 a) Excellent b) Good c) Satisfactory d) Poor
4. Have you got enough idea about PCB design Process?
 a) Excellent b) Good c) Satisfactory d) Poor
5. What is your opinion about the industry person content delivery and time management?
 a) Excellent b) Good c) Satisfactory d) Poor
6. Did the Course cover what you were expecting?
 a) Excellent b) Good c) Satisfactory d) Poor
7. Have you recommend the course in future?
 a) Yes b) No

Suggestions if any:**PRINCIPAL**

K.S.R. COLLEGE OF ENGINEERING
 K.S.R. Kalvi Nagar, Tiruchengode-637
 Namakkal Dist., Tamilnadu

[Handwritten Signature]
 08/4/22

Signature of the student with date

K.S.R. COLLEGE OF ENGINEERING, TIRUCHENGODE – 637 215**(An Autonomous Institution, Affiliated to Anna University, Chennai & Accredited by NAAC with 'A' Grade)****DEPARTMENT OF ELECTRICAL AND ELECTRONICS ENGINEERING****Value Added Course (VAC)****On****"Printed Circuit Board Design and Fabrication"****05th April 2022 to 08th April 2022****Date: 08.04.2022****FEEDBACK FORM**

1. Have you understood the concepts PCB Design?
a) Excellent b) Good c) Satisfactory d) Poor
2. Are you satisfied with the components that could be used for PCB Design?
a) Excellent b) Good c) Satisfactory d) Poor
3. Are you familiar with programming concepts of PCB Design?
a) Excellent b) Good c) Satisfactory d) Poor
4. Have you got enough idea about PCB design Process?
a) Excellent b) Good c) Satisfactory d) Poor
5. What is your opinion about the industry person content delivery and time management?
a) Excellent b) Good c) Satisfactory d) Poor
6. Did the Course cover what you were expecting?
a) Excellent b) Good c) Satisfactory d) Poor
7. Have you recommend the course in future?
a) Yes b) No

Suggestions if any:**PRINCIPAL**

K.S.R. COLLEGE OF ENGINEERING
K.S.R. Kalvi Nagar, Tiruchengode-637 215
Namakkal Dist., Tamilnadu

V. Somashekar
8.4.22

Signature of the student with date

K.S.R. COLLEGE OF ENGINEERING, TIRUCHENGODE – 637 215

(An Autonomous Institution, Affiliated to Anna University, Chennai & Accredited by NAAC with 'A' Grade)

DEPARTMENT OF ELECTRICAL AND ELECTRONICS ENGINEERING

Value Added Course (VAC)

On



“Printed Circuit Board Design and Fabrication”

05th April 2022 to 08th April 2022

Date: 08.04.2022

FEEDBACK FORM

1. Have you understood the concepts PCB Design?
 a) Excellent b) Good c) Satisfactory d) Poor
2. Are you satisfied with the components that could be used for PCB Design?
 a) Excellent b) Good c) Satisfactory d) Poor
3. Are you familiar with programming concepts of PCB Design?
 a) Excellent b) Good c) Satisfactory d) Poor
4. Have you got enough idea about PCB design Process?
 a) Excellent b) Good c) Satisfactory d) Poor
5. What is your opinion about the industry person content delivery and time management?
 a) Excellent b) Good c) Satisfactory d) Poor
6. Did the Course cover what you were expecting?
 a) Excellent b) Good c) Satisfactory d) Poor
7. Have you recommend the course in future?
 a) Yes b) No

Suggestions if any:

[Handwritten Signature]
PRINCIPAL

S. Sanyal 8/4/22
Signature of the student with date

K.S.R.COLLEGE OF ENGINEERING
K.S.R.Kalvi Nagar, Tiruchengode-637 215
Namakkal Dist., Tamilnadu



K.S.R. COLLEGE OF ENGINEERING, TIRUCHENGODE – 637 215

(An Autonomous Institution, Affiliated to Anna University, Chennai & Accredited by NAAC with 'A' Grade)

DEPARTMENT OF ELECTRICAL AND ELECTRONICS ENGINEERING

Value Added Course (VAC)

On

"Printed Circuit Board Design and Fabrication"

05th April 2022 to 08th April 2022

Date: 08.04.2022



FEEDBACK FORM

1. Have you understood the concepts PCB Design?
 a) Excellent b) Good c) Satisfactory d) Poor
2. Are you satisfied with the components that could be used for PCB Design?
 a) Excellent b) Good c) Satisfactory d) Poor
3. Are you familiar with programming concepts of PCB Design?
 a) Excellent b) Good c) Satisfactory d) Poor
4. Have you got enough idea about PCB design Process?
 a) Excellent b) Good c) Satisfactory d) Poor
5. What is your opinion about the industry person content delivery and time management?
 a) Excellent b) Good c) Satisfactory d) Poor
6. Did the Course cover what you were expecting?
 a) Excellent b) Good c) Satisfactory d) Poor
7. Have you recommend the course in future?
 a) Yes b) No

Suggestions if any: *NIL*

[Handwritten Signature]

PRINCIPAL
K.S.R.COLLEGE OF ENGINEERING
K.S.R.Kalvi Nagar, Tiruchengode-637 215
Namakkal Dist., Tamilnadu

[Handwritten Signature]
Signature of the student with date
08/04/22



KSRCE/IQAC/2021-2022/EEE/IC4-64

K.S.R. COLLEGE OF ENGINEERING, TIRUCHENGODE – 637 215**(An Autonomous Institution, Affiliated to Anna University, Chennai & Accredited by NAAC with 'A' Grade)****DEPARTMENT OF ELECTRICAL AND ELECTRONICS ENGINEERING****Value Added Course (VAC)****On****“Printed Circuit Board Design and Fabrication”****05th April 2022 to 08th April 2022****Date: 08.04.2022****FEEDBACK FORM**

1. Have you understood the concepts PCB Design?
 a) Excellent b) Good c) Satisfactory d) Poor
2. Are you satisfied with the components that could be used for PCB Design?
 a) Excellent b) Good c) Satisfactory d) Poor
3. Are you familiar with programming concepts of PCB Design?
 a) Excellent b) Good c) Satisfactory d) Poor
4. Have you got enough idea about PCB design Process?
 a) Excellent b) Good c) Satisfactory d) Poor
5. What is your opinion about the industry person content delivery and time management?
 a) Excellent b) Good c) Satisfactory d) Poor
6. Did the Course cover what you were expecting?
 a) Excellent b) Good c) Satisfactory d) Poor
7. Have you recommend the course in future?
 a) Yes b) No

Suggestions if any:

PRINCIPAL
 K.S.R. COLLEGE OF ENGINEERING
 K.S.R. Kalvi Nagar, Tiruchengode-637 215
 Namakkal Dist., Tamilnadu

S. Kammuraj
 08/04/22
Signature of the student with date



KSRCE/IQAC/2021-2022/EEE/IC4-64

K.S.R. COLLEGE OF ENGINEERING, TIRUCHENGODE – 637 215**(An Autonomous Institution, Affiliated to Anna University, Chennai & Accredited by NAAC with 'A' Grade)****DEPARTMENT OF ELECTRICAL AND ELECTRONICS ENGINEERING****Value Added Course (VAC)****On****“Printed Circuit Board Design and Fabrication”****05th April 2022 to 08th April 2022****Date: 08.04.2022****FEEDBACK FORM**

1. Have you understood the concepts PCB Design?
 a) Excellent b) Good c) Satisfactory d) Poor
2. Are you satisfied with the components that could be used for PCB Design?
 a) Excellent b) Good c) Satisfactory d) Poor
3. Are you familiar with programming concepts of PCB Design?
 a) Excellent b) Good c) Satisfactory d) Poor
4. Have you got enough idea about PCB design Process?
 a) Excellent b) Good c) Satisfactory d) Poor
5. What is your opinion about the industry person content delivery and time management?
 a) Excellent b) Good c) Satisfactory d) Poor
6. Did the Course cover what you were expecting?
 a) Excellent b) Good c) Satisfactory d) Poor
7. Have you recommend the course in future?
 a) Yes b) No

Suggestions if any: NIL**PRINCIPAL**

K.S.R. COLLEGE OF ENGINEERING
K.S.R. Kalvi Nagar, Tiruchengode-637 215
Namakkal Dist., Tamilnadu

R. Dady
 08/04/22
Signature of the student with date

K.S.R. COLLEGE OF ENGINEERING, TIRUCHENGODE – 637 215

(An Autonomous Institution, Affiliated to Anna University, Chennai & Accredited by NAAC with 'A' Grade)

DEPARTMENT OF ELECTRICAL AND ELECTRONICS ENGINEERING

Value Added Course (VAC)

On

“Printed Circuit Board Design and Fabrication”

05th April 2022 to 08th April 2022

Date: 08.04.2022



FEEDBACK FORM

- 1. Have you understood the concepts PCB Design?
 a) Excellent b) Good c) Satisfactory d) Poor
- 2. Are you satisfied with the components that could be used for PCB Design?
 a) Excellent b) Good c) Satisfactory d) Poor
- 3. Are you familiar with programming concepts of PCB Design?
 a) Excellent b) Good c) Satisfactory d) Poor
- 4. Have you got enough idea about PCB design Process?
 a) Excellent b) Good c) Satisfactory d) Poor
- 5. What is your opinion about the industry person content delivery and time management?
 a) Excellent b) Good c) Satisfactory d) Poor
- 6. Did the Course cover what you were expecting?
 a) Excellent b) Good c) Satisfactory d) Poor
- 7. Have you recommend the course in future?
 a) Yes b) No

Suggestions if any: NIL

PRINCIPAL
K.S.R.COLLEGE OF ENGINEERING
K.S.R.Kalvi Nagar, Tiruchengode-6
Namakkal Dist., Tamilnadu

D. Perumal
08/04/22

Signature of the student with date



K.S.R. COLLEGE OF ENGINEERING, TIRUCHENGODE – 637 215

(An Autonomous Institution, Affiliated to Anna University, Chennai & Accredited by NAAC with 'A' Grade)

DEPARTMENT OF ELECTRICAL AND ELECTRONICS ENGINEERING

Value Added Course (VAC)

On

"Printed Circuit Board Design and Fabrication"

05th April 2022 to 08th April 2022

Date: 08.04.2022



FEEDBACK FORM

1. Have you understood the concepts PCB Design?
 a) Excellent b) Good c) Satisfactory d) Poor
2. Are you satisfied with the components that could be used for PCB Design?
 a) Excellent b) Good c) Satisfactory d) Poor
3. Are you familiar with programming concepts of PCB Design?
 a) Excellent b) Good c) Satisfactory d) Poor
4. Have you got enough idea about PCB design Process?
 a) Excellent b) Good c) Satisfactory d) Poor
5. What is your opinion about the industry person content delivery and time management?
 a) Excellent b) Good c) Satisfactory d) Poor
6. Did the Course cover what you were expecting?
 a) Excellent b) Good c) Satisfactory d) Poor
7. Have you recommend the course in future?
 a) Yes b) No

Suggestions if any:

[Handwritten signature in green ink]

PRINCIPAL
K.S.R.COLLEGE OF ENGINEERING
K.S.R.Kalvi Nagar, Tiruchengode-637 215
Namakkal Dist., Tamilnadu

V. Sreelakshmi 08/04/2022

Signature of the student with date



K.S.R. COLLEGE OF ENGINEERING, TIRUCHENGODE – 637 215**(An Autonomous Institution, Affiliated to Anna University, Chennai & Accredited by NAAC with 'A' Grade)****DEPARTMENT OF ELECTRICAL AND ELECTRONICS ENGINEERING****Value Added Course (VAC)****On****"Printed Circuit Board Design and Fabrication"****05th April 2022 to 08th April 2022****Date: 08.04.2022****FEEDBACK FORM**

1. Have you understood the concepts PCB Design?
a) Excellent b) Good c) Satisfactory d) Poor
2. Are you satisfied with the components that could be used for PCB Design?
a) Excellent b) Good c) Satisfactory d) Poor
3. Are you familiar with programming concepts of PCB Design?
a) Excellent b) Good c) Satisfactory d) Poor
4. Have you got enough idea about PCB design Process?
a) Excellent b) Good c) Satisfactory d) Poor
5. What is your opinion about the industry person content delivery and time management?
a) Excellent b) Good c) Satisfactory d) Poor
6. Did the Course cover what you were expecting?
a) Excellent b) Good c) Satisfactory d) Poor
7. Have you recommend the course in future?
a) Yes b) No

Suggestions if any: -

A.P. Raj 8.4.22

Signature of the student with date**PRINCIPAL**

K.S.R. COLLEGE OF ENGINEERING
K.S.R. Kalvi Nagar, Tiruchengode-637 215
Namakkal Dist., Tamilnadu

K.S.R. COLLEGE OF ENGINEERING, TIRUCHENGODE – 637 215**(An Autonomous Institution, Affiliated to Anna University, Chennai & Accredited by NAAC with 'A' Grade)****DEPARTMENT OF ELECTRICAL AND ELECTRONICS ENGINEERING****Value Added Course (VAC)****On****"Printed Circuit Board Design and Fabrication"****05th April 2022 to 08th April 2022****Date: 08.04.2022****FEEDBACK FORM**

1. Have you understood the concepts PCB Design?
a) Excellent b) Good c) Satisfactory d) Poor
2. Are you satisfied with the components that could be used for PCB Design?
a) Excellent b) Good c) Satisfactory d) Poor
3. Are you familiar with programming concepts of PCB Design?
a) Excellent b) Good c) Satisfactory d) Poor
4. Have you got enough idea about PCB design Process?
a) Excellent b) Good c) Satisfactory d) Poor
5. What is your opinion about the industry person content delivery and time management?
a) Excellent b) Good c) Satisfactory d) Poor
6. Did the Course cover what you were expecting?
a) Excellent b) Good c) Satisfactory d) Poor
7. Have you recommend the course in future?
a) Yes b) No

Suggestions if any:

PRINCIPAL
K.S.R. COLLEGE OF ENGINEERING
K.S.R. Kalvi Nagar, Tiruchengode-637 215
Namakkal Dist., Tamilnadu

Signature of the student with date

N. G. Prathap
8.04.22

K.S.R. COLLEGE OF ENGINEERING, TIRUCHENGODE – 637 215

(An Autonomous Institution, Affiliated to Anna University, Chennai & Accredited by NAAC with 'A' Grade)

DEPARTMENT OF ELECTRICAL AND ELECTRONICS ENGINEERING

Value Added Course (VAC)

On



“Printed Circuit Board Design and Fabrication”

05th April 2022 to 08th April 2022

Date: 08.04.2022

FEEDBACK FORM

1. Have you understood the concepts PCB Design?
 a) Excellent b) Good c) Satisfactory d) Poor
2. Are you satisfied with the components that could be used for PCB Design?
 a) Excellent b) Good c) Satisfactory d) Poor
3. Are you familiar with programming concepts of PCB Design?
 a) Excellent b) Good c) Satisfactory d) Poor
4. Have you got enough idea about PCB design Process?
 a) Excellent b) Good c) Satisfactory d) Poor
5. What is your opinion about the industry person content delivery and time management?
 a) Excellent b) Good c) Satisfactory d) Poor
6. Did the Course cover what you were expecting?
 a) Excellent b) Good c) Satisfactory d) Poor
7. Have you recommend the course in future?
 a) Yes b) No

Suggestions if any:



[Handwritten signature in green ink]

PRINCIPAL
K.S.R. COLLEGE OF ENGINEERING
K.S.R. Kalvi Nagar, Tiruchengode-637 215
Namakkal Dist., Tamilnadu

[Handwritten signature in black ink]
21/4/22

Signature of the student with date

K.S.R. COLLEGE OF ENGINEERING, TIRUCHENGODE – 637 215**(An Autonomous Institution, Affiliated to Anna University, Chennai & Accredited by NAAC with 'A' Grade)****DEPARTMENT OF ELECTRICAL AND ELECTRONICS ENGINEERING****Value Added Course (VAC)****On****"Printed Circuit Board Design and Fabrication"****05th April 2022 to 08th April 2022****Date: 08.04.2022****FEEDBACK FORM**

1. Have you understood the concepts PCB Design?
a) Excellent b) Good c) Satisfactory d) Poor
2. Are you satisfied with the components that could be used for PCB Design?
a) Excellent b) Good c) Satisfactory d) Poor
3. Are you familiar with programming concepts of PCB Design?
a) Excellent b) Good c) Satisfactory d) Poor
4. Have you got enough idea about PCB design Process?
a) Excellent b) Good c) Satisfactory d) Poor
5. What is your opinion about the industry person content delivery and time management?
a) Excellent b) Good c) Satisfactory d) Poor
6. Did the Course cover what you were expecting?
a) Excellent b) Good c) Satisfactory d) Poor
7. Have you recommend the course in future?
a) Yes b) No

Suggestions if any:

PRINCIPAL
K.S.R. COLLEGE OF ENGINEERING
 K.S.R., Kalvi Nagar, Tiruchengode-637 215
 Namakkal Dist., Tamilnadu

Signature of the student with date



K.S.R.COLLEGE OF ENGINEERING, TIRUCHENGODE – 637 215

(An Autonomous Institution, Affiliated to Anna University, Chennai & Accredited by NAAC with 'A' Grade)

DEPARTMENT OF ELECTRICAL AND ELECTRONICS ENGINEERING

Value Added Course (VAC)

On

"Printed Circuit Board Design and Fabrication"

05th April 2022 to 08th April 2022

PHOTOGRAPHY

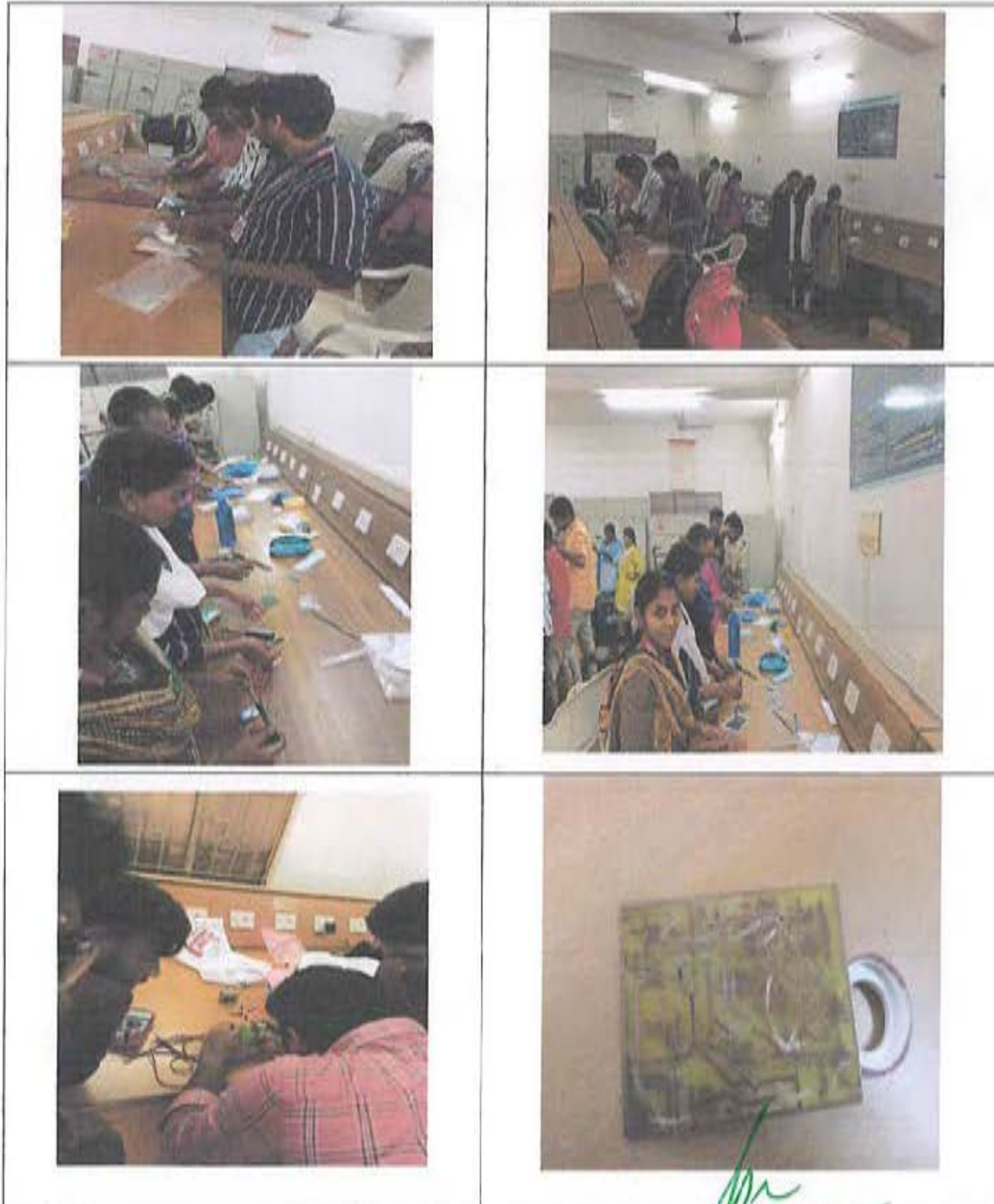

Planned
12/04/2022
Course Coordinator
(Dr. M. Ramasa)



[Signature]
PRINCIPAL
K.S.R.COLLEGE OF ENGINEERING
K.S.R.Kalvi Nagar, Tiruchengode-637 215
Namakkal Dist., Tamilnadu

[Signature]
HOD/EEE

Printed Circuit Board Design and Fabrication

Presented By

T. Anand M.E
Training Engineer
Innospace Automation Services Private
Limited
Chennai - 600 083

- And multi layer is not possible to manufacturing at home.
- Conductors on different layers are connected with plated-through holes called vias.
- And also it is very easy to make a PCB at home at very low of cost.



Introduction

- A **Printed Circuit Board (PCB)** electrically connects electronic components using tracks, pads
- PCBs can be single sided, double sided or multi-layer.
- Total thickness of PCB is 1.6mm

PCB Tools

- Altium Designer
- AutoDesk Eagle
- Cadence
- Allegro
- KiCad
- EasyEDA
- Etc...

PRINCIPAL
K.S.R.COLLEGE OF ENGINEERING
K.S.R.Kalvi Nagar, Tiruchengode-637 215
Namakkal Dist., Tamilnadu

Procedure for Electronic Circuit Design

- Circuit Analysis
- Design and Simulation
- Component Selection
- Testing
- Making Schematic
- Prepare BOM File
- Board Design
- Fabrication
- Placement
- Overall Testing

Design Procedure for PCB

- Making Schematic
- Creating Library if Needed
- ERC (Error Rule Check)
- Generate BOM
- Creating Board
- Set Board Dimension
- Placement
- Tracing
- DRC (Design Rule Check)
- Gerber Generation
- Send to Fabricator

Design Layers for Double Side

- Top layer
- Bottom Layer
- Solder Mask Top
- Solder Mask Bottom
- Silk Screen Top
- Silk Screen Bottom



PRINCIPAL
K.S.R. COLLEGE OF ENGINEERING
K.S.R. Kalvi Nagar, Tiruchengode-637 215
Namakkal Dist., Tamilnadu

Layers

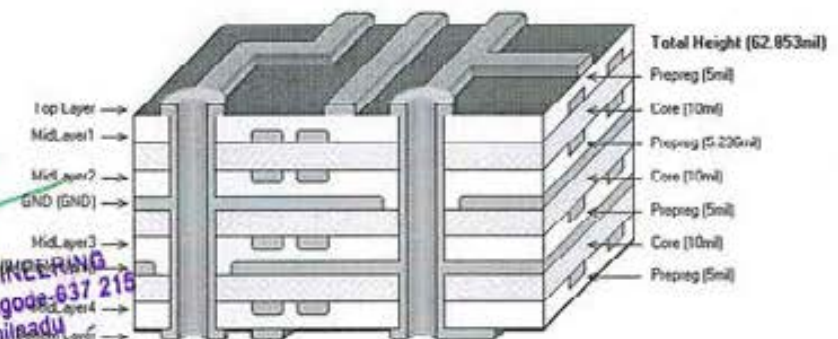

Silk Screen and Solder Mask

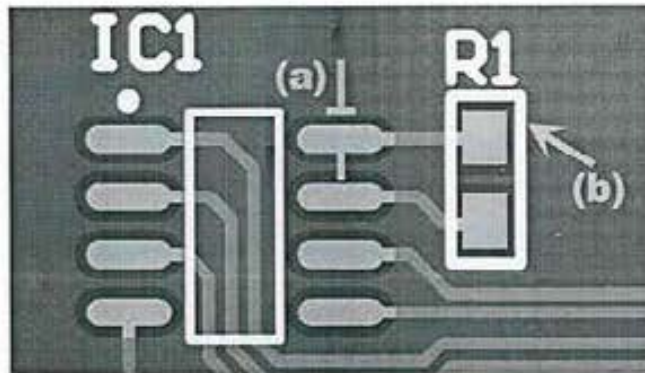

Gerber File

- BOM – Bill Of Material
- Copper Top
- Copper Bottom
- Solder Mask Top
- Solder Mask Bottom
- Solder Paste Top
- Solder Paste Bottom
- Silk Screen Top
- Silk Screen Bottom
- Drill File
- Mechanical Layer (if required)
- Pick and Place file (if required) – for SMD

PCB Fabricators

- PCBPower
- ZXHPCB
- PCBWAY
- JLCPCB
- AIIPCB



PCB Process

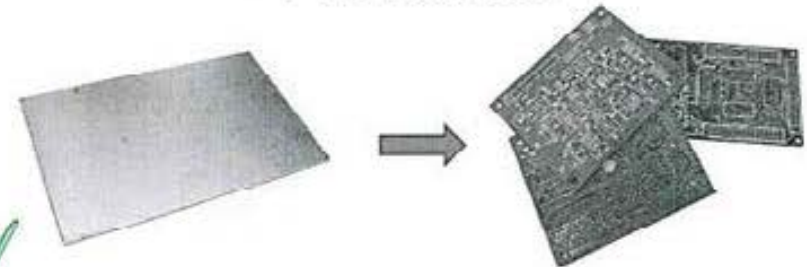

- Changing the copper clad into Printed circuit board with trace, holes, Vias etc.,

At least components are soldered with lead and soldering iron.

PRINCIPAL
K.S.R. COLLEGE OF ENGINEERING
K.S.R. Kalvi Nagar, Tiruchengode-617 215
Namakkal Dist., Tamilnadu

Methods of Manufacturing PCB at Home

There are so many methods are they some of the methods where mentioned below.

1. Toner Transfer method
2. Photo-resist method
3. Screen printing method and etc.,

Toner Transfer Method

- Toner Transfer method is used to manufacture Small quantity of board. i.e. one or two
- It is very simple method
- Ferric chloride is used as Etching solution
- Glossy paper is used to transfer the Trace to the board.

Toner Transfer Process

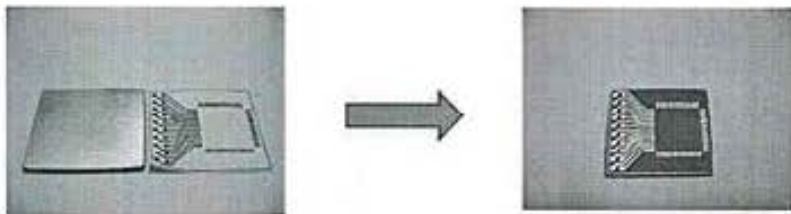

- At first heat the copper clad and then place the glossy paper which contains trace and place it on the surface of the clad.
- And heat once again with laminator and remove the paper now trace will stick to the clad.
- Using Ferric chloride as Etching solution will etch the copper and then clean with acetone.



Pictures of Toner Transfer Method



PRINCIPAL
S.R. COLLEGE OF ENGINEERING
K.S.R. Nagar, Tiruchengode-637 215
Tamilnadu

Merits and Demerits of Toner Transfer Method

Merits:-

- It is very cheap to do
- Time consumption to make a PCB is very less

Demerits:-

- Accuracy of the trace is very less.
- Solder-Mask can't be done by this method.

Photo-Resist Method

- Photo-Resist method is used to manufacture Maximum amount of board. i.e. one to Many boards.
- It is also very simple and easy method.
- Time consumption is low when compared to the Toner Transfer method.
- Instead of glossy paper, the OHP sheet and Photo-Resist film is used.
- Using this method double side trace can be done.
- And UV lights are used to expose the photo-resist film.

Photo-Resist Process

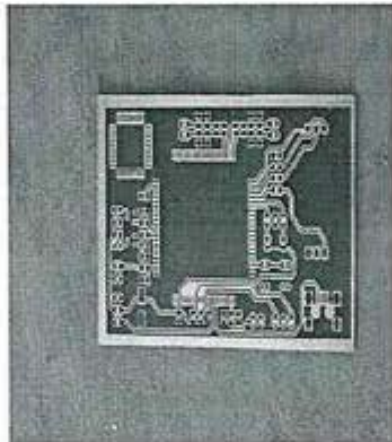

- Clean and dry the clad, Photo-resist film is placed in the surface of the clad
- Now the clad is expose to the UV light with Trace where OHP is printed.
- At last the clad is ready to etch



Pictures of Photo-Resist Method

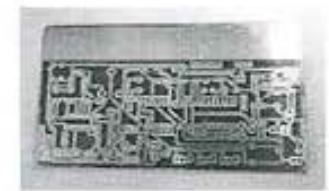

PRINCIPAL
K.S.R. COLLEGE OF ENGINEERING
K.S.R. Kalvi Nagar, Tiruchengode-637 015
Namakkal Dist., Tamil Nadu

Merits and Demerits of Photo-Resist Method

Merits:-

- It is very cheap to do and large amount of order can be done by this method.
- Accuracy of the trace is very high like professional.

Demerits:-

- For larger amount the cost of the PCB is More Photo – resist film is need to buy.
- Time consumption to make a PCB is more when compared to the Toner Transfer method.

Screen Printing Method

- Screen Printing method is used to manufacture Maximum amount of board only. i.e. More than 10 boards. If reduce the board then increase the manufacture cost.
- It is hard to make when compare to the other methods.
- Time consumption is low while manufacture large amount of clad.
- Instead of glossy paper, OHP sheet and Photo-Resist film the photo screen printing solution is used.

Screen Printing Process



- Using photo screen printing solution trace, silk screen and solder mask template is prepared.
- Ink is used for trace, silk screen and solder mask.
- By sliding the ink from Upside to downside in the template then the ink is spread evenly on the copper clad.
- Now it is ready to expose in the UV light.



Pictures of Screen Printing Method



PRINCIPAL
K.S.R. COLLEGE OF ENGINEERING
K.S.R. Kalvi Nagar, Tiruchengode-637 215
Namakkal Dist., Tamilnadu

Merits and Demerits of Screen Printing Method

Merits:-

- It is very cheap to do and large amount of order can be done by this method.
- Accuracy of the trace is very high like professional.

Demerits:-

- Making template is little complex.
- More UV ink is required to do.

Overall Advantages

- Time consumption to make a PCB is very less
- PCB can be manufacture using House hold products.
- Both double layer and single layer can be done
- Solder Mask is also can be done.

Overall Disadvantages

- Chemicals which is used are very toxic
- Disposal of chemical is very complicated.
- Proper protection should be takes place.
- Multi layer PCBs can't be manufacture at the home



PRINCIPAL
 K.S.R.COLLEGE OF ENGINEERING
 K. S.R. Kalvi Nagar, Tiruchengode-637 215
 Namakkal Dist., Tamilnadu

K.S.R. COLLEGE OF ENGINEERING: TIRUCHENGODE – 637 215
DEPARTMENT OF ELECTRICAL AND ELECTRONICS ENGINEERING

CHECK LIST FOR VALUE ADDED COURSE

Name of the Programme: Value Added Course on.....

"Programmable Logic Controller".....

Type of Programme : Self Supported / Sponsored

Funding Agency & Amount (if Funded):

Date of the Programme: 19.04.2022 to 22.04.2022.....

Name of the Coordinator(s): Dr. M. Ramasamy & Dr. M. Vijayakumar.....

Check list for the submission of documents for Value Added Course (VAC)

S.No.	Particular	Tick
1.	Approval/Permission Letter	Yes/No
2.	Circular	Yes/No
3.	Invitation, Acceptance and Thanks Letters	Yes/No
4.	Profile of the Resource Person	<input checked="" type="checkbox"/> Yes/No
5.	Course Content with Course Outcome	<input checked="" type="checkbox"/> Yes/No
6.	Course Fees Details	<input checked="" type="checkbox"/> Yes/No
7.	Quotation (if applicable)	Yes/ <input checked="" type="checkbox"/> No
8.	List of Participants	<input checked="" type="checkbox"/> Yes/No
9.	Attendance Sheet	<input checked="" type="checkbox"/> Yes/No
10.	Sample Certificates	<input checked="" type="checkbox"/> Yes/No
11.	Feedback of the Participants	<input checked="" type="checkbox"/> Yes/No
12.	Expenditure Details	<input checked="" type="checkbox"/> Yes/No
13.	Photographs of the Programme	<input checked="" type="checkbox"/> Yes/No
14.	Course Materials (If Any)	<input checked="" type="checkbox"/> Yes/No

28/04/2022
 Coordinator



 HoD/EEE

PRINCIPAL
 K.S.R. COLLEGE OF ENGINEERING
 K.S.R. Kalvi Nagar, Tiruchengode-637 215
 Namakkal Dist., Tamilnadu

From

Dr.M.Ramasamy,
Associate Professor / EEE,
K.S.R. College of Engineering,
Tiruchengode - 637215.

To

The Principal,
K.S.R. College of Engineering,
K.S.R. Kalvi Nagar,
Tiruchengode – 637215.

Sir,

Sub.: Requisition to grant the Permission to Conduct a Value Added Course on Programmable Logic Controller (PLC) – Reg.,

The department of EEE has planned to conduct a Value Added Course on “Programmable Logic Controller (PLC)” to Final Year EEE students during 19.04.2022 to 22.04.2022. Kindly grant the permission to conduct the above said course in our college premises during the above said period.

Course Schedule:

Duration of the Course	: 19.04.2022 to 22.04.2022 (04 Days)
No. of Hours	: 32 Hours (8 Hrs/Day)
Course Fees	: 1000 / Students
Total Number of Students	: 28
Venue	: Computer Laboratory

Resource Person: Mr. Mohammed Fareed, Project Engineer, IPCS Global Solutions Private Limited – 636004.

Faculty In-charge: 1. Dr.M.Ramasamy, ASP/EEE 2. Dr.M.Vijayakumar, AP/EEE

Thanking You

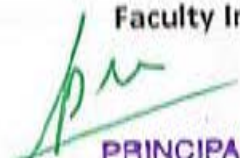
PRINCIPAL
K.S.R.COLLEGE OF ENGINEERING
K.S.R.Kalvi Nagar, Tiruchengode - 637 215
Namakkal Dist., Tamilnadu

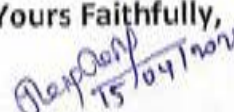

Yours Faithfully,

(Dr.M.Ramasamy)

K.S.R. COLLEGE OF ENGINEERING: TIRUCHENGODE - 637 215
DEPARTMENT OF ELECTRICAL AND ELECTRONICS ENGINEERING
(Autonomous)

Date: 18.04.2022

Time: 10.30 a.m.

CIRCULAR

Classification	√ ROUTINE	IMMEDIATE
ORIGINATOR: HoD / EEE	CIRCULATED TO: IV EEE Students & Faculty Concern	

Sub.: Conduction of Value Added Course on Programmable Logic Controller (PLC) – Reg.,

The department of EEE has planned to conduct a Value Added Course on "Programmable Logic Controller (PLC)" to Final Year EEE students during 19th April 2022 to 22nd April 2022. In connection with this, the regular classes for the following registered candidates are cancelled and the faculty members are asked to mark their absents as on duty/permission.

LIST OF PARTICIPANTS

S. No.	Reg. No.	Name of the Student
1.	1914009	GOWTHAM V
2.	1914010	HARI GOKUL S
3.	1914011	HARI VIGNESH S
4.	1914012	HEMNATH V
5.	1914013	INFANTJENIFER R
6.	1914014	JANANI S
7.	1914015	JEEVANANDHAM S
8.	1914016	JEEVITHA G
9.	1914019	KARMUKILAN S
10.	1914020	KAVIN C
11.	1914022	KEERTHINATHAN R
12.	1914024	KISHORE S
13.	1914029	NALAN R
14.	1914030	NAVEEN A
15.	1914031	NAVEEN KUMAR P
16.	1914032	PERUMAL D
17.	1914035	PREM PRAKASH S
18.	1914036	RANJITHKUMAR R
19.	1914042	SOMESHKANNAN V
20.	1914043	SRIDHAR A
21.	1914044	SUBASH G
22.	1914046	SURYAPRAKASH S
23.	1914503	GOWRIT T
24.	1914504	GUNA M



18/04/2022
 Course Coordinator

[Signature]
 PRINCIPAL

K.S.R. COLLEGE OF ENGINEERING
 K.S.R. Kalvi Nagar, Tiruchengode-637 215
 Namakkal Dist., Tamilnadu

[Signature]
 HoD/EEE



K.S.R. COLLEGE OF ENGINEERING

(An Autonomous Institution, Approved by AICTE, New Delhi, Affiliated to Anna University, Chennai,
Accredited by NAAC with 'A' Grade and ISO 9001:2008 Certified Institution)

R. SRINIVASAN B.B.M.,
Chairman cum Managing Trustee

Dr. P. SENTHIL KUMAR M.E., Ph.D.,(ITM)
Principal

Date: 14.04.2022

To

MOHAMMED FAREED
PROJECT ENGINEER,
JPCS GLOBAL SOLUTIONS PRIVATE LIMITED,
SALEM - 636004.

Dear Sir,

Sub.: Guest Invitation for the Value Added Course Titled "**Programmable Logic Controller (PLC)**" – Reg.,

The Electrical and Electronics Engineering Department intends to offer a Value Added Course on "**Programmable Logic Controller (PLC)**" to our branch's final-year students from 19th April 2022 to 22nd April 2022. In this regard, it gives us great pleasure to extend an invitation to you for the aforementioned value-added course. Your knowledge and experience will definitely improve the programme, in my opinion. I'm really anticipating your approval as soon as possible.

Thanking You



PRINCIPAL

PRINCIPAL
K.S.R. COLLEGE OF ENGINEERING
K.S.R. KALVI NAGAR,
TIRUCHENGODE-637 215



K.S.R. COLLEGE OF ENGINEERING

(An Autonomous Institution, Approved by AICTE, New Delhi, Affiliated to Anna University, Chennai,
Accredited by NAAC with 'A' Grade and ISO 9001:2008 Certified Institution)

R. SRINIVASAN B.B.M.,
Chairman cum Managing Trustee

Dr. P. SENTHIL KUMAR M.E., Ph.D., (IITM)
Principal

Date: 22.04.2022

To

MOHAMMED FAREED
PROJECT ENGINEER,
IPCS GLOBAL SOLUTIONS PRIVATE LIMITED,
SALEM - 636004.

Sir,

Sub.: Letter of Appreciation – Reg.,

We would like to express our gratitude for your informative and stimulating lecture in the Value Added Course Titled "**Programmable Logic Controller (PLC)**", which was co-hosted by the Department of Electrical and Electronics Engineering and IPCS Global Solutions Private Limited, Salem, from 19th April 2022 to 22nd April 2022. In order to continue promoting professional education in the future, we look forward to your cooperation.

Thanking You



PRINCIPAL

PRINCIPAL
K.S.R. COLLEGE OF ENGINEERING
K.S.R. KALVI NAGAR,
TIRUCHENGODE-637 215



MOHAMMED FAREED B.E(EEE)

Project Engineer

IPCS GLOBAL SOLUTIONS PVT. LTD.

PERSONAL SUMMARY

A competent Project Engineer with excellent communication, organization and co-ordination skills. Possessing a proven track record of preparing and executing project plans and programmes, ensuring that work is carried out in accordance with the companies procedures and clients satisfaction. Able to ensure timely, safe and cost effective design and implementation during the life cycle of projects from conception till customer satisfaction.

Currently looking for a suitable Project Engineer or consultant position with a forward thinking employer

AREAS OF EXPERTISE

- Project management*
- Industrial Automation*
- IT skills*
- Technical plans*
- Oil & Gas industry*

PERSONAL SKILLS

- Commercial acumen*
- Enthusiastic*
- Attention to detail*

PERSONAL DETAILS

Mohammed Fareed
mdfareed.contact@gmail.com

ACADEMIC

QUALIFICATIONS

B.E (ELECTRICAL & ELECTRONICS ENGINEERING) - KARPAGAM COLLEGE OF ENGINEERING, COIMBATORE.

WORK EXPERIENCE

IPCS GLOBAL SOLUTIONS PVT LTD

PROJECT ENGINEER April 2021 - Present

LSS -Logical Support and Solutions

PROJECT ENGINEER March 2020 – April 2021

Ensuring that all engineering work is carried out in accordance with specifications, statutory requirements, laws, rules, regulations and other contractual requirements. With due regards to safety, operability and maintainability

Duties:

- Managing projects from conception, pre-production through to completion.
- Providing technical support to the project team and wider regional teams.
- Responsible for overseeing the review, initiation and execution of contracts.
- Overseeing the maintenance of projects after completion.
- Responsible for the completion of all documentation.
- Producing Test Plans and reports.
- Carrying out effective client liaison for all projects undertaken.

Projects Handled:

- PLC program for Heating System in IOCL, Hyderabad.
- Automating Wooden Cutting machine
- PLC programming and HMI programming for Warping and beaming machine.
- Automatic Chocolate grinding machine for Australian client.
- Smart Electric Vehicle.
- Scada System development and programming for oil and gas industry.
- Automating pre existing machineries in Food Industry.

KEY SKILLS AND COMPETENCIES

- Extensive experience of planning, project management, design & client liaison.
- Experience of interpreting specifications and preparing technical proposals.
- Ability to multi-task in a demanding engineering environment.
- A strong track record in delivering projects on time and within budget.
- Resolving complex technical issues and coming up with fast efficient solutions.



[Signature]
PRINCIPAL
K.S.R. COLLEGE OF ENGINEERING
 K.S.R. Kalvi Nagar, Tiruchengode-637 215
 Namakkal Dist., Tamilnadu



K.S.R.COLLEGE OF ENGINEERING, TIRUCHENGODE – 637 215
(An Autonomous Institution, Affiliated to Anna University, Chennai & Accredited by NAAC with 'A' Grade)

DEPARTMENT OF ELECTRICAL AND ELECTRONICS ENGINEERING

Value Added Course

On

“Programmable Logic Controller (PLC)”

19th April 2022 to 22nd April 2022

OUTCOME	Related POs and PSOs
<p>Course Outcomes:</p> <p>On Completion of this Course, the student will be able to</p> <ol style="list-style-type: none"> 1. Explain the major components of programmable logic controller and its applications. 2. Summarize the logical functions, timers and counters of PLC. 3. Discuss the various instructions and modes of operation related to PLC. 4. Examine the different applications of PLC and Distributed Control Systems. 5. Develop PLC program and importance of SCADA in DCS in industrial application. 	<p>PO1,PO2,PO3,PO6,PO7, PO12,PSO1</p>

Plan/Sigab
25/04/2022
Coordinator



[Signature]
PRINCIPAL

K.S.R.COLLEGE OF ENGINEERING
K.S.R.Kalvi Nagar, Tiruchengode-637 215
Namakkal Dist., Tamilnadu

[Signature]
HoD/EEE

K.S.R: COLLEGE OF ENGINEERING (Autonomous): TIRUCHENGODE – 637 215

DEPARTMENT OF ELECTRICAL AND ELECTRONICS ENGINEERING



Value Added Course (VAC)

On

"Programmable Logic Controller (PLC)"

19th April 2022 to 22nd April 2022COURSE FEES DETAILS

S. No.	Reg. No.	Name of the Student	Course Fees in Rs.	Signature
1.	1814001	AKASH K	1000	Akash
2.	1814003	DEEPANRAJ M	1000	Deepanraj
3.	1814006	GOKILA R	1000	Gokila
4.	1814009	KARANSANTH E	1000	Karansanth
5.	1814011	MANORANJITH S	1000	Manoranjith
6.	1814013	SABAREESWARAN M	1000	Sabareeswaran
7.	1814016	SRIDHAR M	1000	Sridhar
8.	1814017	SRIRAM M	1000	Sriram
9.	1814501	AJITH N	1000	Ajith
10.	1814502	AJITHKUMAR M	1000	Ajithkumar
11.	1814503	ARUNRAJ	1000	Arunraj
12.	1814506	ELAMATHI S	1000	S. Elamathi
13.	1814507	ELANGO M	1000	Elango
14.	1814512	JEEVANANTHAM S	1000	Jeevanantham
15.	1814513	JEGANATHAN V	1000	Jeganathan
16.	1814516	MANIVEL M	1000	Manivel
17.	1814517	MONISHWARAN S	1000	Monishwaran
18.	1814518	NARAYANAN M	1000	Narayanan
19.	1814519	NAVEEN K	1000	Naveen
20.	1814520	NAVEEN KUMAR M	1000	Naveen Kumar
21.	1814521	NIRMALNATHAN B	1000	Nirmalnathan
22.	1814522	NITHESHWARAN K	1000	Nitheshwaran
23.	1814525	RANJITH P	1000	Ranjith
24.	1814529	SELVAKUMAR V	1000	Selvakumar
25.	1814530	SHARMILA J	1000	Sharmila
26.	1814531	SHIBIN JOSWA E	1000	Shibin
27.	1814532	THAMARAISELVAN V	1000	Thamaraivelvan
28.	1814537	VIVEKA S	1000	S. Viveka
Total Amount in Rs.			28000/-	



Course Coordinator

(Dr. M. Ramasamy)

PRINCIPAL
K.S.R. COLLEGE OF ENGINEERING
K.S.R. Kalvi Nagar, Tiruchengode-637 215
Namakkal Dist., Tamilnadu

HoD/EEE

K.S.R. COLLEGE OF ENGINEERING (Autonomous): TIRUCHENGODE – 637 215
DEPARTMENT OF ELECTRICAL AND ELECTRONICS ENGINEERING



Value Added Course (VAC)
On
“Programmable Logic Controller (PLC)”
19th April 2022 to 22nd April 2022

LIST OF REGISTERED PARTICIPANTS

S. No.	Reg. No.	Name of the Student	S. No.	Reg. No.	Name of the Student
1.	1814001	AKASH K	15.	1814513	JEGANATHAN V
2.	1814003	DEEPANRAJ M	16.	1814516	MANIVEL M
3.	1814006	GOKILA R	17.	1814517	MONISHWARAN S
4.	1814009	KARANSANTH E	18.	1814518	NARAYANAN M
5.	1814011	MANORANJITH S	19.	1814519	NAVEEN K
6.	1814013	SABAREESWARAN M	20.	1814520	NAVEEN KUMAR M
7.	1814016	SRIDHAR M	21.	1814521	NIRMALNATHAN B
8.	1814017	SRIRAM M	22.	1814522	NITHESHWARAN K
9.	1814501	AJITH N	23.	1814525	RANJITH P
10.	1814502	AJITHKUMAR M	24.	1814529	SELVAKUMAR V
11.	1814503	ARUNRAJ	25.	1814530	SHARMILA J
12.	1814506	ELAMATHI S	26.	1814531	SHIBIN JOSWA E
13.	1814507	ELANGO M	27.	1814532	THAMARAISELVAN V
14.	1814512	JEEVANANTHAM S	28.	1814537	VIVEKA S

Dr. M. Ramasamy
18/04/2022
Course Coordinator
(Dr. M. Ramasamy)

[Signature]
18/04/22
HoD/EEE



[Signature]
PRINCIPAL
K.S.R. COLLEGE OF ENGINEERING
K.S.R. Kalvi Nagar, Tiruchengode-637 215
Namakkal Dist., Tamilnadu



K.S.R. COLLEGE OF ENGINEERING: TIRUCHENGODE – 637 215
DEPARTMENT OF ELECTRICAL AND ELECTRONICS ENGINEERING

Value Added Course (VAC) On
“Programmable Logic Controller (PLC)”
19th April 2022 to 22nd April 2022

S. No.	Reg. No.	Name of the Student	19.04.2022		20.04.2022		21.04.2022		22.04.2022	
			FN	AN	FN	AN	FN	AN	FN	AN
1.	1814001	AKASH K	Akash	Akash	Akash	Akash	Akash	Akash	Akash	Akash
2.	1814003	DEEPANRAJ M	Deepanraj	Deepanraj	Deepanraj	Deepanraj	Deepanraj	Deepanraj	Deepanraj	Deepanraj
3.	1814006	GOKILA R	Gokila	Gokila	Gokila	Gokila	Gokila	Gokila	Gokila	Gokila
4.	1814009	KARANSANTH E	Karansanth	Karansanth	Karansanth	Karansanth	Karansanth	Karansanth	Karansanth	Karansanth
5.	1814011	MANORANJITH S	Manoranjith	Manoranjith	Manoranjith	Manoranjith	Manoranjith	Manoranjith	Manoranjith	Manoranjith
6.	1814013	SABAREESWARAN M	Sabareeswaran	Sabareeswaran	Sabareeswaran	Sabareeswaran	Sabareeswaran	Sabareeswaran	Sabareeswaran	Sabareeswaran
7.	1814016	SRIDHAR M	Sridhar	Sridhar	Sridhar	Sridhar	Sridhar	Sridhar	Sridhar	Sridhar
8.	1814017	SRIRAM M	Sriram	Sriram	Sriram	Sriram	Sriram	Sriram	Sriram	Sriram
9.	1814501	AJITH N	Ajith	Ajith	Ajith	Ajith	Ajith	Ajith	Ajith	Ajith
10.	1814502	AJITHKUMAR M	Ajithkumar	Ajithkumar	Ajithkumar	Ajithkumar	Ajithkumar	Ajithkumar	Ajithkumar	Ajithkumar
11.	1814503	ARUNRAJ	Arunraj	Arunraj	Arunraj	Arunraj	Arunraj	Arunraj	Arunraj	Arunraj
12.	1814506	ELAMATHI S	Elamathi	Elamathi	Elamathi	Elamathi	Elamathi	Elamathi	Elamathi	Elamathi
13.	1814507	ELANGO M	Elango	Elango	Elango	Elango	Elango	Elango	Elango	Elango
14.	1814512	JEEVANANTHAM S	Jeevanantham	Jeevanantham	Jeevanantham	Jeevanantham	Jeevanantham	Jeevanantham	Jeevanantham	Jeevanantham
15.	1814513	JEGANATHAN V	Jeganathan	Jeganathan	Jeganathan	Jeganathan	Jeganathan	Jeganathan	Jeganathan	Jeganathan
16.	1814516	MANIVEL M	Manivel	Manivel	Manivel	Manivel	Manivel	Manivel	Manivel	Manivel
17.	1814517	MONISHWARAN S	Monishwaran	Monishwaran	Monishwaran	Monishwaran	Monishwaran	Monishwaran	Monishwaran	Monishwaran
18.	1814518	NARAYANAN M	Narayanan	Narayanan	Narayanan	Narayanan	Narayanan	Narayanan	Narayanan	Narayanan
19.	1814519	NAVEEN K	Naveen	Naveen	Naveen	Naveen	Naveen	Naveen	Naveen	Naveen
20.	1814520	NAVEEN KUMAR M	Naveenkumar	Naveenkumar	Naveenkumar	Naveenkumar	Naveenkumar	Naveenkumar	Naveenkumar	Naveenkumar
21.	1814521	NIRMALNATHAN B	Nirmalnathan	Nirmalnathan	Nirmalnathan	Nirmalnathan	Nirmalnathan	Nirmalnathan	Nirmalnathan	Nirmalnathan
22.	1814522	NITHESHWARAN K	Nitheshwaran	Nitheshwaran	Nitheshwaran	Nitheshwaran	Nitheshwaran	Nitheshwaran	Nitheshwaran	Nitheshwaran
23.	1814525	RANJITH P	Ranjith	Ranjith	Ranjith	Ranjith	Ranjith	Ranjith	Ranjith	Ranjith
24.	1814529	SELVAKUMAR V	Selvakumar	Selvakumar	Selvakumar	Selvakumar	Selvakumar	Selvakumar	Selvakumar	Selvakumar
25.	1814530	SHARMILA J	Sharmila	Sharmila	Sharmila	Sharmila	Sharmila	Sharmila	Sharmila	Sharmila
26.	1814531	SHIBIN JOSWA E	Shibin	Shibin	Shibin	Shibin	Shibin	Shibin	Shibin	Shibin
27.	1814532	THAMARASELVAN V	Thamaraselvan	Thamaraselvan	Thamaraselvan	Thamaraselvan	Thamaraselvan	Thamaraselvan	Thamaraselvan	Thamaraselvan
28.	1814537	VIVEKA S	Viveka	Viveka	Viveka	Viveka	Viveka	Viveka	Viveka	Viveka



Manojkumar
22/04/2022
Course Coordinator

[Signature]
PRINCIPAL
 K.S.R.COLLEGE OF ENGINEERING
 K.S.R.Kalvi Nagar, Tiruchengode-637 215
 Namakkal Dist., Tamilnadu

[Signature]
HoD/EEE

K.S.R. College of Engineering

in Association with

IPCS Global Solutions



Certificate of Participation

This is to certify that **V. Gowtham** of Department of Electrical and Electronics Engineering has participated in the four days value added course on “**Programmable Logic Controller (PLC)**” held from **19th April 2022 to 22nd April 2022** conducted by **IPCS Global Solutions Private Limited** at K.S.R. College of Engineering, Tiruchengode.

S. Aravinth
Branch Manager

IPCS Global Solutions Private Limited
Salem



PRINCIPAL
K.S.R. COLLEGE OF ENGINEERING
K.S.R. Kalvi Nagar, Tiruchengode-637 215
Namakkal Dist., Tamilnadu

K.S.R. College of Engineering

in Association with

IPCS Global Solutions



Certificate of Participation

This is to certify that **S. Hari Gokul** of Department of Electrical and Electronics Engineering has participated in the four days value added course on “**Programmable Logic Controller (PLC)**” held from **19th April 2022 to 22nd April 2022** conducted by **IPCS Global Solutions Private Limited** at K.S.R. College of Engineering, Tiruchengode.

S. Aravinth
Branch Manager

IPCS Global Solutions Private Limited
Salem



PRINCIPAL
K.S.R. COLLEGE OF ENGINEERING
K.S.R. Kalvi Nagar, Tiruchengode-637 215
Namakkal Dist., Tamilnadu

K.S.R. College of Engineering

in Association with

IPCS Global Solutions



Certificate of Participation

This is to certify that **S. Hari Vignesh** of Department of Electrical and Electronics Engineering has participated in the four days value added course on “**Programmable Logic Controller (PLC)**” held from **19th April 2022 to 22nd April 2022** conducted by **IPCS Global Solutions Private Limited** at K.S.R. College of Engineering, Tiruchengode.

S. Aravinth
Branch Manager

IPCS Global Solutions Private Limited
Salem



PRINCIPAL
K.S.R. COLLEGE OF ENGINEERING
K.S.R. Kalvi Nagar, Tiruchengode-637 215
Namakkal Dist., Tamilnadu

K.S.R. College of Engineering

in Association with

IPCS Global Solutions



Certificate of Participation

This is to certify that **V. Hemnath** of Department of Electrical and Electronics Engineering has participated in the four days value added course on “**Programmable Logic Controller (PLC)**” held from **19th April 2022 to 22nd April 2022** conducted by **IPCS Global Solutions Private Limited** at K.S.R. College of Engineering, Tiruchengode.

S. Aravinth
Branch Manager

IPCS Global Solutions Private Limited
Salem



PRINCIPAL
K.S.R. COLLEGE OF ENGINEERING
K.S.R. Kalvi Nagar, Tiruchengode-637 215
Namakkal Dist., Tamilnadu

K.S.R. College of Engineering

in Association with

IPCS Global Solutions



Certificate of Participation

This is to certify that **S.Janani** of Department of Electrical and Electronics Engineering has participated in the four days value added course on “**Programmable Logic Controller (PLC)**” held from **19th April 2022 to 22nd April 2022** conducted by **IPCS Global Solutions Private Limited** at K.S.R. College of Engineering, Tiruchengode.

S. Aravinth
Branch Manager

IPCS Global Solutions Private Limited
Salem



PRINCIPAL
K.S.R. COLLEGE OF ENGINEERING
K.S.R. Kalvi Nagar, Tiruchengode-637 215
Namakkal Dist., Tamilnadu

K.S.R. College of Engineering

in Association with

IPCS Global Solutions



Certificate of Participation

This is to certify that **C.KAVIN** of Department of Electrical and Electronics Engineering has participated in the four days value added course on “**Programmable Logic Controller (PLC)**” held from **19th April 2022 to 22nd April 2022** conducted by **IPCS Global Solutions Private Limited** at K.S.R. College of Engineering, Tiruchengode.

S. Aravinth
Branch Manager

IPCS Global Solutions Private Limited
Salem



PRINCIPAL
K.S.R. COLLEGE OF ENGINEERING
K.S.R. Kalvi Nagar, Tiruchengode-637 215
Namakkal Dist., Tamilnadu

K.S.R. College of Engineering

in Association with

IPCS Global Solutions



Certificate of Participation

This is to certify that **R. KEERTHINATHAN** of Department of Electrical and Electronics Engineering has participated in the four days value added course on **“Programmable Logic Controller (PLC)”** held from **19th April 2022 to 22nd April 2022** conducted by **IPCS Global Solutions Private Limited** at K.S.R. College of Engineering, Tiruchengode.

S. Aravinth

Branch Manager

IPCS Global Solutions Private Limited

Salem





PRINCIPAL

K.S.R. COLLEGE OF ENGINEERING
K.S.R. Kalvi Nagar, Tiruchengode-637 215
Namakkal Dist., Tamilnadu

K.S.R. College of Engineering

in Association with

IPCS Global Solutions



Certificate of Participation

This is to certify that **A. Naveen** of Department of Electrical and Electronics Engineering has participated in the four days value added course on “**Programmable Logic Controller (PLC)**” held from **19th April 2022 to 22nd April 2022** conducted by **IPCS Global Solutions Private Limited** at K.S.R. College of Engineering, Tiruchengode.

S. Aravinth
Branch Manager

IPCS Global Solutions Private Limited
Salem



PRINCIPAL
K.S.R. COLLEGE OF ENGINEERING
K.S.R. Kalvi Nagar, Tiruchengode-637 215
Namakkal Dist., Tamilnadu

K.S.R. College of Engineering

in Association with

IPCS Global Solutions



Certificate of Participation

This is to certify that **P. Naveen Kumar** of Department of Electrical and Electronics Engineering has participated in the four days value added course on “**Programmable Logic Controller (PLC)**” held from **19th April 2022 to 22nd April 2022** conducted by **IPCS Global Solutions Private Limited** at K.S.R. College of Engineering, Tiruchengode.

S. Aravinth
Branch Manager

IPCS Global Solutions Private Limited
Salem



PRINCIPAL
K.S.R.COLLEGE OF ENGINEERING
K.S.R.Kalvi Nagar, Tiruchengode-637 215
Namakkal Dist., Tamilnadu

K.S.R. College of Engineering

in Association with

IPCS Global Solutions



Certificate of Participation

This is to certify that **M. Guna** of Department of Electrical and Electronics Engineering has participated in the four days value added course on “**Programmable Logic Controller (PLC)**” held from **19th April 2022 to 22nd April 2022** conducted by **IPCS Global Solutions Private Limited** at K.S.R. College of Engineering, Tiruchengode.

S. Aravinth
Branch Manager

IPCS Global Solutions Private Limited
Salem



PRINCIPAL
K.S.R. COLLEGE OF ENGINEERING
K.S.R. Kalvi Nagar, Tiruchengode-637 215
Namakkal Dist., Tamilnadu

**K.S.R.COLLEGE OF ENGINEERING, TIRUCHENGODE – 637 215**

(An Autonomous Institution, Affiliated to Anna University, Chennai & Accredited by NAAC with 'A' Grade)

DEPARTMENT OF ELECTRICAL AND ELECTRONICS ENGINEERING**Value Added Course (VAC)****On****“Programmable Logic Controller (PLC)”****19th April 2022 to 22nd April 2022****FEEDBACK ANALYSIS**

S.No.	Parameters	Excellent	Good	Satisfactory	Poor
1	Have you understood the function of PLC?	6	22	-	-
2	How was the content discuss the types of programmable logic controllers?	9	13	6	-
3	Are you satisfied with the components that make the programmable logic controller work?	10	10	8	-
4	Have you got enough idea about sequence of PLC operation?	6	18	4	-
5	Are you familiar with programming concepts?	10	11	7	-
6	What is your opinion about the knowledge of the industry person?	12	12	3	1
7	Did the Course cover what you were expecting?	11	14	3	-
	Total	64	100	31	1
		32.65%	51.02%	15.81%	-

Course Coordinator
25/4/22
HoD/EEE
25/4/22**PRINCIPAL**
K.S.R.COLLEGE OF ENGINEERING
K.S.R.Kalvi Nagar, Tiruchengode-637 215
Namakkal Dist., Tamilnadu



K.S.R.COLLEGE OF ENGINEERING, TIRUCHENGODE – 637 215

(An Autonomous Institution, Affiliated to Anna University, Chennai & Accredited by NAAC with 'A' Grade)

DEPARTMENT OF ELECTRICAL AND ELECTRONICS ENGINEERING

Value Added Course (VAC)

On

“Programmable Logic Controller (PLC)”

19th April 2022 to 22nd April 2022

FEEDBACK FORM

1. Have you understood the function of PLC?

a) Excellent	b) <u>Good</u>	c) Satisfactory	d) Poor
--------------	----------------	-----------------	---------
2. How was the content discuss the types of programmable logic controllers?

a) Excellent	b) <u>Good</u>	c) Satisfactory	d) Poor
--------------	----------------	-----------------	---------
3. Are you satisfied with the components that make the programmable logic controller work?

a) Excellent	b) Good	c) <u>Satisfactory</u>	d) Poor
--------------	---------	------------------------	---------
4. Have you got enough idea about sequence of PLC operation?

a) Excellent	b) <u>Good</u>	c) Satisfactory	d) Poor
--------------	----------------	-----------------	---------
5. Are you familiar with programming concepts?

a) Excellent	b) Good	c) <u>Satisfactory</u>	d) Poor
--------------	---------	------------------------	---------
6. What is your opinion about the knowledge of the industry person?

a) Excellent	b) <u>Good</u>	c) Satisfactory	d) Poor
--------------	----------------	-----------------	---------
7. Did the Course cover what you were expecting?

a) Excellent	b) <u>Good</u>	c) Satisfactory	d) Poor
--------------	----------------	-----------------	---------

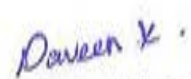

 PRINCIPAL
 K.S.R.COLLEGE OF ENGINEERING
 K.S.R.Kalvi Nagar, Tiruchengode-637 215
 Namakkal Dist., Tamil Nadu

 Signature of the student



K.S.R.COLLEGE OF ENGINEERING, TIRUCHENGODE – 637 215

(An Autonomous Institution, Affiliated to Anna University, Chennai & Accredited by NAAC with 'A' Grade)

DEPARTMENT OF ELECTRICAL AND ELECTRONICS ENGINEERING

Value Added Course (VAC)

On

“Programmable Logic Controller (PLC)”

19th April 2022 to 22nd April 2022

FEEDBACK FORM

1. Have you understood the function of PLC?

a) Excellent b) Good c) Satisfactory d) Poor

2. How was the content discuss the types of programmable logic controllers?

a) Excellent b) Good c) Satisfactory d) Poor

3. Are you satisfied with the components that make the programmable logic controller work?

a) Excellent b) Good c) Satisfactory d) Poor

4. Have you got enough idea about sequence of PLC operation?

a) Excellent b) Good c) Satisfactory d) Poor

5. Are you familiar with programming concepts?

a) Excellent b) Good c) Satisfactory d) Poor

6. What is your opinion about the knowledge of the industry person?

a) Excellent b) Good c) Satisfactory d) Poor

7. Did the Course cover what you were expecting?

a) Excellent b) Good c) Satisfactory d) Poor



PRINCIPAL

K.S.R.COLLEGE OF ENGINEERING
K.S.R.Kalvi Nagar, Tiruchengode-637 215,
Namakkal Dist., Tamilnadu.

Signature of the student



K.S.R.COLLEGE OF ENGINEERING, TIRUCHENGODE – 637 215

[An Autonomous Institution, Affiliated to Anna University, Chennai & Accredited by NAAC with 'A' Grade]

DEPARTMENT OF ELECTRICAL AND ELECTRONICS ENGINEERING

Value Added Course (VAC)

On

“Programmable Logic Controller (PLC)”

19th April 2022 to 22nd April 2022

FEEDBACK FORM

1. Have you understood the function of PLC?

- a) Excellent
- b) Good
- c) Satisfactory
- d) Poor

2. How was the content discuss the types of programmable logic controllers?

- a) Excellent
- b) Good
- c) Satisfactory
- d) Poor

3. Are you satisfied with the components that make the programmable logic controller work?

- a) Excellent
- b) Good
- c) Satisfactory
- d) Poor

4. Have you got enough idea about sequence of PLC operation?

- a) Excellent
- b) Good
- c) Satisfactory
- d) Poor

5. Are you familiar with programming concepts?

- a) Excellent
- b) Good
- c) Satisfactory
- d) Poor

6. What is your opinion about the knowledge of the industry person?

- a) Excellent
- b) Good
- c) Satisfactory
- d) Poor

7. Did the Course cover what you were expecting?

- a) Excellent
- b) Good
- c) Satisfactory
- d) Poor



[Handwritten signature in green ink]

PRINCIPAL
K.S.R.COLLEGE OF ENGINEERING
K.S.R.Kalvi Nagar, Tiruchengode-637 215
Namakkal Dist., Tamilnadu

[Handwritten signature in black ink]

Signature of the student



K.S.R.COLLEGE OF ENGINEERING, TIRUCHENGODE – 637 215

(An Autonomous Institution, Affiliated to Anna University, Chennai & Accredited by NAAC with 'A' Grade)

DEPARTMENT OF ELECTRICAL AND ELECTRONICS ENGINEERING

Value Added Course (VAC)

On

“Programmable Logic Controller (PLC)”

19th April 2022 to 22nd April 2022

FEEDBACK FORM

1. Have you understood the function of PLC?

- a) Excellent
- b) Good
- c) Satisfactory
- d) Poor

2. How was the content discuss the types of programmable logic controllers?

- a) Excellent
- b) Good
- c) Satisfactory
- d) Poor

3. Are you satisfied with the components that make the programmable logic controller work?

- a) Excellent
- b) Good
- c) Satisfactory
- d) Poor

4. Have you got enough idea about sequence of PLC operation?

- a) Excellent
- b) Good
- c) Satisfactory
- d) Poor

5. Are you familiar with programming concepts?

- a) Excellent
- b) Good
- c) Satisfactory
- d) Poor

6. What is your opinion about the knowledge of the industry person?

- a) Excellent
- b) Good
- c) Satisfactory
- d) Poor

7. Did the Course cover what you were expecting?

- a) Excellent
- b) Good
- c) Satisfactory
- d) Poor



PRINCIPAL
K.S.R.COLLEGE OF ENGINEERING
K.S.R.Kalvi Nagar, Tiruchengode-637 215
Namakkal Dist., Tamilnadu

Signature of the student



K.S.R.COLLEGE OF ENGINEERING, TIRUCHENGODE – 637 215

(An Autonomous Institution, Affiliated to Anna University, Chennai & Accredited by NAAC with 'A' Grade)

DEPARTMENT OF ELECTRICAL AND ELECTRONICS ENGINEERING

Value Added Course (VAC)

On

“Programmable Logic Controller (PLC)”

19th April 2022 to 22nd April 2022

FEEDBACK FORM

1. Have you understood the function of PLC?

a) Excellent b) Good c) Satisfactory d) Poor

2. How was the content discuss the types of programmable logic controllers?

a) Excellent b) Good c) Satisfactory d) Poor

3. Are you satisfied with the components that make the programmable logic controller work?

a) Excellent b) Good c) Satisfactory d) Poor

4. Have you got enough idea about sequence of PLC operation?

a) Excellent b) Good c) Satisfactory d) Poor

5. Are you familiar with programming concepts?

a) Excellent b) Good c) Satisfactory d) Poor

6. What is your opinion about the knowledge of the industry person?

a) Excellent b) Good c) Satisfactory d) Poor

7. Did the Course cover what you were expecting?

a) Excellent b) Good c) Satisfactory d) Poor



[Handwritten Signature]

PRINCIPAL
K.S.R.COLLEGE OF ENGINEERING
K.S.R.Kalvi Nagar, Tiruchengode-637 215
Namakkal Dist., Tamilnadu

[Handwritten Signature]
Signature of the student



K.S.R.COLLEGE OF ENGINEERING, TIRUCHENGODE – 637 215

(An Autonomous Institution, Affiliated to Anna University, Chennai & Accredited by NAAC with 'A' Grade)

DEPARTMENT OF ELECTRICAL AND ELECTRONICS ENGINEERING

Value Added Course (VAC)

On

“Programmable Logic Controller (PLC)”

19th April 2022 to 22nd April 2022

FEEDBACK FORM

1. Have you understood the function of PLC?

a) Excellent b) Good c) Satisfactory d) Poor

2. How was the content discuss the types of programmable logic controllers?

a) Excellent b) Good c) Satisfactory d) Poor

3. Are you satisfied with the components that make the programmable logic controller work?

a) Excellent b) Good c) Satisfactory d) Poor

4. Have you got enough idea about sequence of PLC operation?

a) Excellent b) Good c) Satisfactory d) Poor

5. Are you familiar with programming concepts?

a) Excellent b) Good c) Satisfactory d) Poor

6. What is your opinion about the knowledge of the industry person?

a) Excellent b) Good c) Satisfactory d) Poor

7. Did the Course cover what you were expecting?

a) Excellent b) Good c) Satisfactory d) Poor



PRINCIPAL
K.S.R.COLLEGE OF ENGINEERING
K.S.R.Kaivi Nagar, Tiruchengode-637 215
Namakkal Dist., Tamilnadu

Deepanshu

Signature of the student



K.S.R.COLLEGE OF ENGINEERING, TIRUCHENGODE – 637 215

(An Autonomous Institution, Affiliated to Anna University, Chennai & Accredited by NAAC with 'A' Grade)

DEPARTMENT OF ELECTRICAL AND ELECTRONICS ENGINEERING

Value Added Course (VAC)

On

“Programmable Logic Controller (PLC)”

19th April 2022 to 22nd April 2022

FEEDBACK FORM

1. Have you understood the function of PLC?

a) Excellent b) Good c) Satisfactory d) Poor

2. How was the content discuss the types of programmable logic controllers?

a) Excellent b) Good c) Satisfactory d) Poor

3. Are you satisfied with the components that make the programmable logic controller work?

a) Excellent b) Good c) Satisfactory d) Poor

4. Have you got enough Idea about sequence of PLC operation?

a) Excellent b) Good c) Satisfactory d) Poor

5. Are you familiar with programming concepts?

a) Excellent b) Good c) Satisfactory d) Poor

6. What is your opinion about the knowledge of the industry person?

a) Excellent b) Good c) Satisfactory d) Poor

7. Did the Course cover what you were expecting?

a) Excellent b) Good c) Satisfactory d) Poor



PRINCIPAL
K.S.R.COLLEGE OF ENGINEERING
K.S.R.Kaivi Nagar, Tiruchengode-637 215
Namakkal Dist., Tamilnadu

Signature of the student



K.S.R.COLLEGE OF ENGINEERING, TIRUCHENGODE – 637 215

(An Autonomous Institution, Affiliated to Anna University, Chennai & Accredited by NAAC with 'A' Grade)

DEPARTMENT OF ELECTRICAL AND ELECTRONICS ENGINEERING

Value Added Course (VAC)

On

“Programmable Logic Controller (PLC)”

19th April 2022 to 22nd April 2022

FEEDBACK FORM

1. Have you understood the function of PLC?

a) Excellent b) Good c) Satisfactory d) Poor

2. How was the content discuss the types of programmable logic controllers?

a) Excellent b) Good c) Satisfactory d) Poor

3. Are you satisfied with the components that make the programmable logic controller work?

a) Excellent b) Good c) Satisfactory d) Poor

4. Have you got enough idea about sequence of PLC operation?

a) Excellent b) Good c) Satisfactory d) Poor

5. Are you familiar with programming concepts?

a) Excellent b) Good c) Satisfactory d) Poor

6. What is your opinion about the knowledge of the industry person?

a) Excellent b) Good c) Satisfactory d) Poor

7. Did the Course cover what you were expecting?

a) Excellent b) Good c) Satisfactory d) Poor



PRINCIPAL
K.S.R. COLLEGE OF ENGINEERING
K.S.R. Kalvi Nagar, Tiruchengode-637 215
Namakkal Dist., Tamilnadu

S. Anbu
Signature of the student



K.S.R.COLLEGE OF ENGINEERING, TIRUCHENGODE – 637 215

(An Autonomous Institution, Affiliated to Anna University, Chennai & Accredited by NAAC with 'A' Grade)

DEPARTMENT OF ELECTRICAL AND ELECTRONICS ENGINEERING

Value Added Course (VAC)

On

“Programmable Logic Controller (PLC)”

19th April 2022 to 22nd April 2022

FEEDBACK FORM

1. Have you understood the function of PLC?

a) Excellent b) Good c) Satisfactory d) Poor

2. How was the content discuss the types of programmable logic controllers?

a) Excellent b) Good c) Satisfactory d) Poor

3. Are you satisfied with the components that make the programmable logic controller work?

a) Excellent b) Good c) Satisfactory d) Poor

4. Have you got enough idea about sequence of PLC operation?

a) Excellent b) Good c) Satisfactory d) Poor

5. Are you familiar with programming concepts?

a) Excellent b) Good c) Satisfactory d) Poor

6. What is your opinion about the knowledge of the industry person?

a) Excellent b) Good c) Satisfactory d) Poor

7. Did the Course cover what you were expecting?

a) Excellent b) Good c) Satisfactory d) Poor



PRINCIPAL

K.S.R. COLLEGE OF ENGINEERING
K.S.R. Kalvi Nagar, Tiruchengode-637 216
Namakkal Dist., Tamilnadu

Sab
Signature of the student



K.S.R.COLLEGE OF ENGINEERING, TIRUCHENGODE – 637 215

(An Autonomous Institution, Affiliated to Anna University, Chennai & Accredited by NAAC with 'A' Grade)

DEPARTMENT OF ELECTRICAL AND ELECTRONICS ENGINEERING

Value Added Course (VAC)

On

“Programmable Logic Controller (PLC)”

19th April 2022 to 22nd April 2022

FEEDBACK FORM

1. Have you understood the function of PLC?

a) Excellent b) Good c) Satisfactory d) Poor

2. How was the content discuss the types of programmable logic controllers?

a) Excellent b) Good c) Satisfactory d) Poor

3. Are you satisfied with the components that make the programmable logic controller work?

a) Excellent b) Good c) Satisfactory d) Poor

4. Have you got enough idea about sequence of PLC operation?

a) Excellent b) Good c) Satisfactory d) Poor

5. Are you familiar with programming concepts?

a) Excellent b) Good c) Satisfactory d) Poor

6. What is your opinion about the knowledge of the industry person?

a) Excellent b) Good c) Satisfactory d) Poor

7. Did the Course cover what you were expecting?

a) Excellent b) Good c) Satisfactory d) Poor



[Signature]
PRINCIPAL
K.S.R.COLLEGE OF ENGINEERING
K.S.R.Kalyal Nagar, Tiruchengode-637 215
Namakkal Dist., Tamilnadu

[Signature]
Signature of the student



K.S.R.COLLEGE OF ENGINEERING, TIRUCHENGODE – 637 215

(An Autonomous Institution, Affiliated to Anna University, Chennai & Accredited by NAAC with 'A' Grade)

DEPARTMENT OF ELECTRICAL AND ELECTRONICS ENGINEERING

Value Added Course (VAC)

On

"Programmable Logic Controller (PLC)"

19th April 2022 to 22nd April 2022

FEEDBACK FORM

1. Have you understood the function of PLC?

a) Excellent

b) Good

c) Satisfactory

d) Poor

2. How was the content discuss the types of programmable logic controllers?

a) Excellent

b) Good

c) Satisfactory

d) Poor

3. Are you satisfied with the components that make the programmable logic controller work?

a) Excellent

b) Good

c) Satisfactory

d) Poor

4. Have you got enough idea about sequence of PLC operation?

a) Excellent

b) Good

c) Satisfactory

d) Poor

5. Are you familiar with programming concepts?

a) Excellent

b) Good

c) Satisfactory

d) Poor

6. What is your opinion about the knowledge of the industry person?

a) Excellent

b) Good

c) Satisfactory

d) Poor

7. Did the Course cover what you were expecting?

a) Excellent

b) Good

c) Satisfactory

d) Poor



[Handwritten signature in green ink]

PRINCIPAL

K.S.R.COLLEGE OF ENGINEERING
K.S.R.Kaivi Nagar, Tiruchengode-637 215
Namakkal Dist., Tamilnadu

[Handwritten signature in blue ink]
Signature of the student



K.S.R.COLLEGE OF ENGINEERING, TIRUCHENGODE – 637 215
 (An Autonomous Institution, Affiliated to Anna University, Chennai & Accredited by NAAC with 'A' Grade)
DEPARTMENT OF ELECTRICAL AND ELECTRONICS ENGINEERING

Value Added Course (VAC)
On
“Programmable Logic Controller (PLC)”

19th April 2022 to 22nd April 2022

FEEDBACK FORM

1. Have you understood the function of PLC?
 a) Excellent b) Good c) Satisfactory d) Poor
2. How was the content discuss the types of programmable logic controllers?
 a) Excellent b) Good c) Satisfactory d) Poor
3. Are you satisfied with the components that make the programmable logic controller work?
 a) Excellent b) Good c) Satisfactory d) Poor
4. Have you got enough idea about sequence of PLC operation?
 a) Excellent b) Good c) Satisfactory d) Poor
5. Are you familiar with programming concepts?
 a) Excellent b) Good c) Satisfactory d) Poor
6. What is your opinion about the knowledge of the industry person?
 a) Excellent b) Good c) Satisfactory d) Poor
7. Did the Course cover what you were expecting?
 a) Excellent b) Good c) Satisfactory d) Poor



[Signature]
 PRINCIPAL
 K.S.R. COLLEGE OF ENGINEERING
 K.S.R. Kalvi Nagar, Tiruchengode-637 215
 Namakkal Dist., Tamilnadu

[Signature]

Signature of the student



K.S.R.COLLEGE OF ENGINEERING, TIRUCHENGODE – 637 215

(An Autonomous Institution, Affiliated to Anna University, Chennai & Accredited by NAAC with 'A' Grade)

DEPARTMENT OF ELECTRICAL AND ELECTRONICS ENGINEERING

Value Added Course (VAC)

On

“Programmable Logic Controller (PLC)”

19th April 2022 to 22nd April 2022

FEEDBACK FORM

1. Have you understood the function of PLC?

a) Excellent b) Good c) Satisfactory d) Poor

2. How was the content discuss the types of programmable logic controllers?

a) Excellent b) Good c) Satisfactory d) Poor

3. Are you satisfied with the components that make the programmable logic controller work?

a) Excellent b) Good c) Satisfactory d) Poor

4. Have you got enough idea about sequence of PLC operation?

a) Excellent b) Good c) Satisfactory d) Poor

5. Are you familiar with programming concepts?

a) Excellent b) Good c) Satisfactory d) Poor

6. What is your opinion about the knowledge of the industry person?

a) Excellent b) Good c) Satisfactory d) Poor

7. Did the Course cover what you were expecting?

a) Excellent b) Good c) Satisfactory d) Poor



PRINCIPAL
K.S.R.COLLEGE OF ENGINEERING
K.S.R.Kalvi Nagar, Tiruchengode-637 215
Namakkal Dist., Tamilnadu

Signature of the student



K.S.R.COLLEGE OF ENGINEERING, TIRUCHENGODE – 637 215
 (An Autonomous Institution, Affiliated to Anna University, Chennai & Accredited by NAAC with 'A' Grade)
DEPARTMENT OF ELECTRICAL AND ELECTRONICS ENGINEERING

Value Added Course (VAC)
On
"Programmable Logic Controller (PLC)"
19th April 2022 to 22nd April 2022
FEEDBACK FORM

1. Have you understood the function of PLC?
 a) Excellent b) Good c) Satisfactory d) Poor
2. How was the content discuss the types of programmable logic controllers?
 a) Excellent b) Good c) Satisfactory d) Poor
3. Are you satisfied with the components that make the programmable logic controller work?
 a) Excellent b) Good c) Satisfactory d) Poor
4. Have you got enough idea about sequence of PLC operation?
 a) Excellent b) Good c) Satisfactory d) Poor
5. Are you familiar with programming concepts?
 a) Excellent b) Good c) Satisfactory d) Poor
6. What is your opinion about the knowledge of the industry person?
 a) Excellent b) Good c) Satisfactory d) Poor
7. Did the Course cover what you were expecting?
 a) Excellent b) Good c) Satisfactory d) Poor



[Handwritten Signature]
 PRINCIPAL
 K.S.R.COLLEGE OF ENGINEERING
 K.S.R.Kalvi Nagar, Tiruchengode-637 215
 Namakkal Dist., Tamilnadu

[Handwritten Signature]
 Signature of the student



K.S.R.COLLEGE OF ENGINEERING, TIRUCHENGODE – 637 215

(An Autonomous Institution, Affiliated to Anna University, Chennai & Accredited by NAAC with 'A' Grade)

DEPARTMENT OF ELECTRICAL AND ELECTRONICS ENGINEERING

Value Added Course (VAC)

On

“Programmable Logic Controller (PLC)”

19th April 2022 to 22nd April 2022

FEEDBACK FORM

1. Have you understood the function of PLC?

a) Excellent b) Good c) Satisfactory d) Poor

2. How was the content discuss the types of programmable logic controllers?

a) Excellent b) Good c) Satisfactory d) Poor

3. Are you satisfied with the components that make the programmable logic controller work?

a) Excellent b) Good c) Satisfactory d) Poor

4. Have you got enough idea about sequence of PLC operation?

a) Excellent b) Good c) Satisfactory d) Poor

5. Are you familiar with programming concepts?

a) Excellent b) Good c) Satisfactory d) Poor

6. What is your opinion about the knowledge of the industry person?

a) Excellent b) Good c) Satisfactory d) Poor

7. Did the Course cover what you were expecting?

a) Excellent b) Good c) Satisfactory d) Poor



PRINCIPAL

K.S.R.COLLEGE OF ENGINEERING
K.S.R.Kalvi Nagar, Tiruchengode-637 215
Namakkal Dist., Tamilnadu

[Handwritten Signature]
Signature of the student



K.S.R.COLLEGE OF ENGINEERING, TIRUCHENGODE – 637 215

(An Autonomous Institution, Affiliated to Anna University, Chennai & Accredited by NAAC with 'A' Grade)

DEPARTMENT OF ELECTRICAL AND ELECTRONICS ENGINEERING

Value Added Course (VAC)

On

“Programmable Logic Controller (PLC)”

19th April 2022 to 22nd April 2022

FEEDBACK FORM

1. Have you understood the function of PLC?

a) Excellent	<input checked="" type="radio"/> b) Good	c) Satisfactory	d) Poor
--------------	--	-----------------	---------

2. How was the content discuss the types of programmable logic controllers?

a) Excellent	b) Good	<input checked="" type="radio"/> c) Satisfactory	d) Poor
--------------	---------	--	---------

3. Are you satisfied with the components that make the programmable logic controller work?

a) Excellent	<input checked="" type="radio"/> b) Good	c) Satisfactory	d) Poor
--------------	--	-----------------	---------

4. Have you got enough idea about sequence of PLC operation?

a) Excellent	<input checked="" type="radio"/> b) Good	c) Satisfactory	d) Poor
--------------	--	-----------------	---------

5. Are you familiar with programming concepts?

a) Excellent	b) Good	<input checked="" type="radio"/> c) Satisfactory	d) Poor
--------------	---------	--	---------

6. What is your opinion about the knowledge of the industry person?

a) Excellent	<input checked="" type="radio"/> b) Good	c) Satisfactory	d) Poor
--------------	--	-----------------	---------

7. Did the Course cover what you were expecting?

a) Excellent	<input checked="" type="radio"/> b) Good	<input checked="" type="radio"/> c) Satisfactory	d) Poor
--------------	--	--	---------



[Handwritten signature in green ink]

PRINCIPAL

K.S.R.COLLEGE OF ENGINEERING
K.S.R.Kalvi Nagar, Tiruchengode-637 215
Namakkal Dist., Tamilnadu

[Handwritten signature in blue ink]
Signature of the student



K.S.R.COLLEGE OF ENGINEERING, TIRUCHENGODE – 637 215

(An Autonomous Institution, Affiliated to Anna University, Chennai & Accredited by NAAC with 'A' Grade)

DEPARTMENT OF ELECTRICAL AND ELECTRONICS ENGINEERING

Value Added Course (VAC)

On

“Programmable Logic Controller (PLC)”

19th April 2022 to 22nd April 2022

FEEDBACK FORM

1. Have you understood the function of PLC?

a) Excellent b) Good c) Satisfactory d) Poor

2. How was the content discuss the types of programmable logic controllers?

a) Excellent b) Good c) Satisfactory d) Poor

3. Are you satisfied with the components that make the programmable logic controller work?

a) Excellent b) Good c) Satisfactory d) Poor

4. Have you got enough idea about sequence of PLC operation?

a) Excellent b) Good c) Satisfactory d) Poor

5. Are you familiar with programming concepts?

a) Excellent b) Good c) Satisfactory d) Poor

6. What is your opinion about the knowledge of the industry person?

a) Excellent b) Good c) Satisfactory d) Poor

7. Did the Course cover what you were expecting?

a) Excellent b) Good c) Satisfactory d) Poor



PRINCIPAL

K.S.R.COLLEGE OF ENGINEERING
K.S.R.Kalvi Nagar, Tiruchengode-637 215
Namakkal Dist., Tamilnadu

Neha
Signature of the student



K.S.R.COLLEGE OF ENGINEERING, TIRUCHENGODE – 637 215

(An Autonomous Institution, Affiliated to Anna University, Chennai & Accredited by NAAC with 'A' Grade)

DEPARTMENT OF ELECTRICAL AND ELECTRONICS ENGINEERING

Value Added Course (VAC)

On

“Programmable Logic Controller (PLC)”

19th April 2022 to 22nd April 2022

FEEDBACK FORM

1. Have you understood the function of PLC?

a) Excellent b) Good c) Satisfactory d) Poor

2. How was the content discuss the types of programmable logic controllers?

a) Excellent b) Good c) Satisfactory d) Poor

3. Are you satisfied with the components that make the programmable logic controller work?

a) Excellent b) Good c) Satisfactory d) Poor

4. Have you got enough idea about sequence of PLC operation?

a) Excellent b) Good c) Satisfactory d) Poor

5. Are you familiar with programming concepts?

a) Excellent b) Good c) Satisfactory d) Poor

6. What is your opinion about the knowledge of the industry person?

a) Excellent b) Good c) Satisfactory d) Poor

7. Did the Course cover what you were expecting?

a) Excellent b) Good c) Satisfactory d) Poor



PRINCIPAL

K.S.R.COLLEGE OF ENGINEERING
K.S.R.Kalvi Nagar, Tiruchengode-637 215
Namakkal Dist., Tamilnadu

Signature of the student



K.S.R.COLLEGE OF ENGINEERING, TIRUCHENGODE – 637 215

(An Autonomous Institution, Affiliated to Anna University, Chennai & Accredited by NAAC with 'A' Grade)

DEPARTMENT OF ELECTRICAL AND ELECTRONICS ENGINEERING

Value Added Course (VAC)

On

"Programmable Logic Controller (PLC)"

19th April 2022 to 22nd April 2022

FEEDBACK FORM

1. Have you understood the function of PLC?

a) Excellent

b) Good

c) Satisfactory

d) Poor

2. How was the content discuss the types of programmable logic controllers?

a) Excellent

b) Good

c) Satisfactory

d) Poor

3. Are you satisfied with the components that make the programmable logic controller work?

a) Excellent

b) Good

c) Satisfactory

d) Poor

4. Have you got enough idea about sequence of PLC operation?

a) Excellent

b) Good

c) Satisfactory

d) Poor

5. Are you familiar with programming concepts?

a) Excellent

b) Good

c) Satisfactory

d) Poor

6. What is your opinion about the knowledge of the industry person?

a) Excellent

b) Good

c) Satisfactory

d) Poor

7. Did the Course cover what you were expecting?

a) Excellent

b) Good

c) Satisfactory

d) Poor



PRINCIPAL

K.S.R.COLLEGE OF ENGINEERING
K.S.R.Kalvi Nagar, Tiruchengode-637 215
Namakkal Dist., Tamilnadu

manvel

Signature of the student



K.S.R.COLLEGE OF ENGINEERING, TIRUCHENGODE – 637 215

(An Autonomous Institution, Affiliated to Anna University, Chennai & Accredited by NAAC with 'A' Grade)

DEPARTMENT OF ELECTRICAL AND ELECTRONICS ENGINEERING

Value Added Course (VAC)

On

“Programmable Logic Controller (PLC)”

19th April 2022 to 22nd April 2022

FEEDBACK FORM

- 1. Have you understood the function of PLC?
 a) Excellent b) Good c) Satisfactory d) Poor
- 2. How was the content discuss the types of programmable logic controllers?
 a) Excellent b) Good c) Satisfactory d) Poor
- 3. Are you satisfied with the components that make the programmable logic controller work?
 a) Excellent b) Good c) Satisfactory d) Poor
- 4. Have you got enough idea about sequence of PLC operation?
 a) Excellent b) Good c) Satisfactory d) Poor
- 5. Are you familiar with programming concepts?
 a) Excellent b) Good c) Satisfactory d) Poor
- 6. What is your opinion about the knowledge of the industry person?
 a) Excellent b) Good c) Satisfactory d) Poor
- 7. Did the Course cover what you were expecting?
 a) Excellent b) Good c) Satisfactory d) Poor



[Handwritten Signature]

PRINCIPAL
K.S.R.COLLEGE OF ENGINEERING
K.S.R.Kalvi Nagar, Tiruchengode-637 215
Namakkal Dist., Tamilnadu.

[Handwritten Signature]
Signature of the student



K.S.R.COLLEGE OF ENGINEERING, TIRUCHENGODE – 637 215
 (An Autonomous Institution, Affiliated to Anna University, Chennai & Accredited by NAAC with 'A' Grade)
DEPARTMENT OF ELECTRICAL AND ELECTRONICS ENGINEERING

Value Added Course (VAC)
On
“Programmable Logic Controller (PLC)”

19th April 2022 to 22nd April 2022

FEEDBACK FORM

1. Have you understood the function of PLC?

- a) Excellent
- b) Good
- c) Satisfactory
- d) Poor

2. How was the content discuss the types of programmable logic controllers?

- a) Excellent
- b) Good
- c) Satisfactory
- d) Poor

3. Are you satisfied with the components that make the programmable logic controller work?

- a) Excellent
- b) Good
- c) Satisfactory
- d) Poor

4. Have you got enough idea about sequence of PLC operation?

- a) Excellent
- b) Good
- c) Satisfactory
- d) Poor

5. Are you familiar with programming concepts?

- a) Excellent
- b) Good
- c) Satisfactory
- d) Poor

6. What is your opinion about the knowledge of the industry person?

- a) Excellent
- b) Good
- c) Satisfactory
- d) Poor

7. Did the Course cover what you were expecting?

- a) Excellent
- b) Good
- c) Satisfactory
- d) Poor



[Handwritten Signature]
 PRINCIPAL

K.S.R.COLLEGE OF ENGINEERING
 K.S.R.Kalvi Nagar, Tiruchengode-637 215
 Namakkal Dist., Tamilnadu

[Handwritten Signature]

Signature of the student



K.S.R.COLLEGE OF ENGINEERING, TIRUCHENGODE – 637 215

(An Autonomous Institution, Affiliated to Anna University, Chennai & Accredited by NAAC with 'A' Grade)

DEPARTMENT OF ELECTRICAL AND ELECTRONICS ENGINEERING

Value Added Course (VAC)

On

“Programmable Logic Controller (PLC)”

19th April 2022 to 22nd April 2022

FEEDBACK FORM

1. Have you understood the function of PLC?

a) Excellent b) Good c) Satisfactory d) Poor

2. How was the content discuss the types of programmable logic controllers?

a) Excellent b) Good c) Satisfactory d) Poor

3. Are you satisfied with the components that make the programmable logic controller work?

a) Excellent b) Good c) Satisfactory d) Poor

4. Have you got enough idea about sequence of PLC operation?

a) Excellent b) Good c) Satisfactory d) Poor

5. Are you familiar with programming concepts?

a) Excellent b) Good c) Satisfactory d) Poor

6. What is your opinion about the knowledge of the industry person?

a) Excellent b) Good c) Satisfactory d) Poor

7. Did the Course cover what you were expecting?

a) Excellent b) Good c) Satisfactory d) Poor



PRINCIPAL

K.S.R.COLLEGE OF ENGINEERING
K.S.R.Kalvi Nagar, Tiruchengode-637 215
Namakkal Dist., Tamilnadu

Signature of the student



K.S.R.COLLEGE OF ENGINEERING, TIRUCHENGODE – 637 215

(An Autonomous Institution, Affiliated to Anna University, Chennai & Accredited by NAAC with 'A' Grade)

DEPARTMENT OF ELECTRICAL AND ELECTRONICS ENGINEERING

Value Added Course (VAC)

On

"Programmable Logic Controller (PLC)"

19th April 2022 to 22nd April 2022

FEEDBACK FORM

1. Have you understood the function of PLC?

a) Excellent b) Good c) Satisfactory d) Poor

2. How was the content discuss the types of programmable logic controllers?

a) Excellent , b) Good c) Satisfactory d) Poor

3. Are you satisfied with the components that make the programmable logic controller work?

a) Excellent b) Good c) Satisfactory d) Poor

4. Have you got enough idea about sequence of PLC operation?

a) Excellent b) Good c) Satisfactory d) Poor

5. Are you familiar with programming concepts?

a) Excellent b) Good c) Satisfactory d) Poor

6. What is your opinion about the knowledge of the industry person?

a) Excellent b) Good c) Satisfactory d) Poor

7. Did the Course cover what you were expecting?

a) Excellent b) Good c) Satisfactory d) Poor



PRINCIPAL
K.S.R.COLLEGE OF ENGINEERING
K.S.R.Kalvi Nagar, Tiruchengode-637 215
Namakkal Dist., Tamilnadu

Aravindhan
Signature of the student



K.S.R.COLLEGE OF ENGINEERING, TIRUCHENGODE – 637 215

(An Autonomous Institution, Affiliated to Anna University, Chennai & Accredited by NAAC with 'A' Grade)

DEPARTMENT OF ELECTRICAL AND ELECTRONICS ENGINEERING

Value Added Course (VAC)

On

“Programmable Logic Controller (PLC)”

19th April 2022 to 22nd April 2022

FEEDBACK FORM

1. Have you understood the function of PLC?

- a) Excellent b) Good c) Satisfactory d) Poor

2. How was the content discuss the types of programmable logic controllers?

- a) Excellent b) Good c) Satisfactory d) Poor

3. Are you satisfied with the components that make the programmable logic controller work?

- a) Excellent b) Good c) Satisfactory d) Poor

4. Have you got enough idea about sequence of PLC operation?

- a) Excellent b) Good c) Satisfactory d) Poor

5. Are you familiar with programming concepts?

- a) Excellent b) Good c) Satisfactory d) Poor

6. What is your opinion about the knowledge of the industry person?

- a) Excellent b) Good c) Satisfactory d) Poor

7. Did the Course cover what you were expecting?

- a) Excellent b) Good c) Satisfactory d) Poor



PRINCIPAL

K.S.R.COLLEGE OF ENGINEERING
K.S.R.Kalvi Nagar, Tiruchengode-637 215
Namakkal Dist., Tamilnadu

Signature of the student

Tha



K.S.R.COLLEGE OF ENGINEERING, TIRUCHENGODE – 637 215

(An Autonomous Institution, Affiliated to Anna University, Chennai & Accredited by NAAC with 'A' Grade)

DEPARTMENT OF ELECTRICAL AND ELECTRONICS ENGINEERING

Value Added Course (VAC)

On

“Programmable Logic Controller (PLC)”

19th April 2022 to 22nd April 2022

FEEDBACK FORM

1. Have you understood the function of PLC?

- a) Excellent
- b) Good
- c) Satisfactory
- d) Poor

2. How was the content discuss the types of programmable logic controllers?

- a) Excellent
- b) Good
- c) Satisfactory
- d) Poor

3. Are you satisfied with the components that make the programmable logic controller work?

- a) Excellent
- b) Good
- c) Satisfactory
- d) Poor

4. Have you got enough idea about sequence of PLC operation?

- a) Excellent
- b) Good
- c) Satisfactory
- d) Poor

5. Are you familiar with programming concepts?

- a) Excellent
- b) Good
- c) Satisfactory
- d) Poor

6. What is your opinion about the knowledge of the industry person?

- a) Excellent
- b) Good
- c) Satisfactory
- d) Poor

7. Did the Course cover what you were expecting?

- a) Excellent
- b) Good
- c) Satisfactory
- d) Poor



PRINCIPAL
 K.S.R.COLLEGE OF ENGINEERING
 K.S.R.Kalvi Nagar, Tiruchengode-637 215
 Namakkal Dist., Tamilnadu

[Handwritten signature]
 Signature of the student



K.S.R.COLLEGE OF ENGINEERING, TIRUCHENGODE – 637 215

(An Autonomous Institution, Affiliated to Anna University, Chennai & Accredited by NAAC with 'A' Grade)

DEPARTMENT OF ELECTRICAL AND ELECTRONICS ENGINEERING

Value Added Course (VAC)

On

“Programmable Logic Controller (PLC)”

19th April 2022 to 22nd April 2022

FEEDBACK FORM

1. Have you understood the function of PLC?

- a) Excellent
- b) Good
- c) Satisfactory
- d) Poor

2. How was the content discuss the types of programmable logic controllers?

- a) Excellent
- b) Good
- c) Satisfactory
- d) Poor

3. Are you satisfied with the components that make the programmable logic controller work?

- a) Excellent
- b) Good
- c) Satisfactory
- d) Poor

4. Have you got enough idea about sequence of PLC operation?

- a) Excellent
- b) Good
- c) Satisfactory
- d) Poor

5. Are you familiar with programming concepts?

- a) Excellent
- b) Good
- c) Satisfactory
- d) Poor

6. What is your opinion about the knowledge of the industry person?

- a) Excellent
- b) Good
- c) Satisfactory
- d) Poor

7. Did the Course cover what you were expecting?

- a) Excellent
- b) Good
- c) Satisfactory
- d) Poor



[Handwritten Signature]

PRINCIPAL

**K.S.R.COLLEGE OF ENGINEERING
K.S.R.Kalvi Nagar, Tiruchengode-637 215
Namakkal Dist., Tamilnadu**

[Handwritten Signature]
Signature of the student



K.S.R.COLLEGE OF ENGINEERING, TIRUCHENGODE – 637 215

(An Autonomous Institution, Affiliated to Anna University, Chennai & Accredited by NAAC with 'A' Grade)

DEPARTMENT OF ELECTRICAL AND ELECTRONICS ENGINEERING

Value Added Course (VAC)

On

“Programmable Logic Controller (PLC)”

19th April 2022 to 22nd April 2022

FEEDBACK FORM

1. Have you understood the function of PLC?

- a) Excellent
- b) Good
- c) Satisfactory
- d) Poor

2. How was the content discuss the types of programmable logic controllers?

- a) Excellent
- b) Good
- c) Satisfactory
- d) Poor

3. Are you satisfied with the components that make the programmable logic controller work?

- a) Excellent
- b) Good
- c) Satisfactory
- d) Poor

4. Have you got enough idea about sequence of PLC operation?

- a) Excellent
- b) Good
- c) Satisfactory
- d) Poor

5. Are you familiar with programming concepts?

- a) Excellent
- b) Good
- c) Satisfactory
- d) Poor

6. What is your opinion about the knowledge of the industry person?

- a) Excellent
- b) Good
- c) Satisfactory
- d) Poor

7. Did the Course cover what you were expecting?

- a) Excellent
- b) Good
- c) Satisfactory
- d) Poor



PRINCIPAL
K.S.R. COLLEGE OF ENGINEERING
K.S.R. Kalvi Nagar, Tiruchengode-637 215
Namakkal Dist., Tamilnadu

Signature of the student



K.S.R.COLLEGE OF ENGINEERING, TIRUCHENGODE – 637 215

(An Autonomous Institution, Affiliated to Anna University, Chennai & Accredited by NAAC with 'A' Grade)

DEPARTMENT OF ELECTRICAL AND ELECTRONICS ENGINEERING

Value Added Course (VAC)

On

"Programmable Logic Controller (PLC)"

19th April 2022 to 22nd April 2022

FEEDBACK FORM

1. Have you understood the function of PLC?

a) Excellent b) Good c) Satisfactory d) Poor

2. How was the content discuss the types of programmable logic controllers?

a) Excellent b) Good c) Satisfactory d) Poor

3. Are you satisfied with the components that make the programmable logic controller work?

a) Excellent b) Good c) Satisfactory d) Poor

4. Have you got enough idea about sequence of PLC operation?

a) Excellent b) Good c) Satisfactory d) Poor

5. Are you familiar with programming concepts?

a) Excellent b) Good c) Satisfactory d) Poor

6. What is your opinion about the knowledge of the industry person?

a) Excellent b) Good c) Satisfactory d) Poor

7. Did the Course cover what you were expecting?

a) Excellent b) Good c) Satisfactory d) Poor



 PRINCIPAL
 K.S.R.COLLEGE OF ENGINEERING
 K.S.R.Kalvi Nagar, Tiruchengode-637 215
 Namakkal Dist., Tamilnadu

 Signature of the student



K.S.R.COLLEGE OF ENGINEERING, TIRUCHENGODE – 637 215

(An Autonomous Institution, Affiliated to Anna University, Chennai & Accredited by NAAC with 'A' Grade)

DEPARTMENT OF ELECTRICAL AND ELECTRONICS ENGINEERING

Value Added Course (VAC)

On

“Programmable Logic Controller (PLC)”

19th April 2022 to 22nd April 2022

FEEDBACK FORM

1. Have you understood the function of PLC?

a) Excellent b) Good c) Satisfactory d) Poor

2. How was the content discuss the types of programmable logic controllers?

a) Excellent b) Good c) Satisfactory d) Poor

3. Are you satisfied with the components that make the programmable logic controller work?

a) Excellent b) Good c) Satisfactory d) Poor

4. Have you got enough idea about sequence of PLC operation?

a) Excellent b) Good c) Satisfactory d) Poor

5. Are you familiar with programming concepts?

a) Excellent b) Good c) Satisfactory d) Poor

6. What is your opinion about the knowledge of the industry person?

a) Excellent b) Good c) Satisfactory d) Poor

7. Did the Course cover what you were expecting?

a) Excellent b) Good c) Satisfactory d) Poor



PRINCIPAL

K.S.R.COLLEGE OF ENGINEERING
K.S.R.Kalvi Nagar, Tiruchengode-637 215
Namakkal Dist., Tamilnadu

Signature of the student



K.S.R.COLLEGE OF ENGINEERING, TIRUCHENGODE – 637 215

(An Autonomous Institution, Affiliated to Anna University, Chennai & Accredited by NAAC with 'A' Grade)

DEPARTMENT OF ELECTRICAL AND ELECTRONICS ENGINEERING

Value Added Course (VAC)

On

“Programmable Logic Controller (PLC)”

19th April 2022 to 22nd April 2022

PHOTOGRAPHY

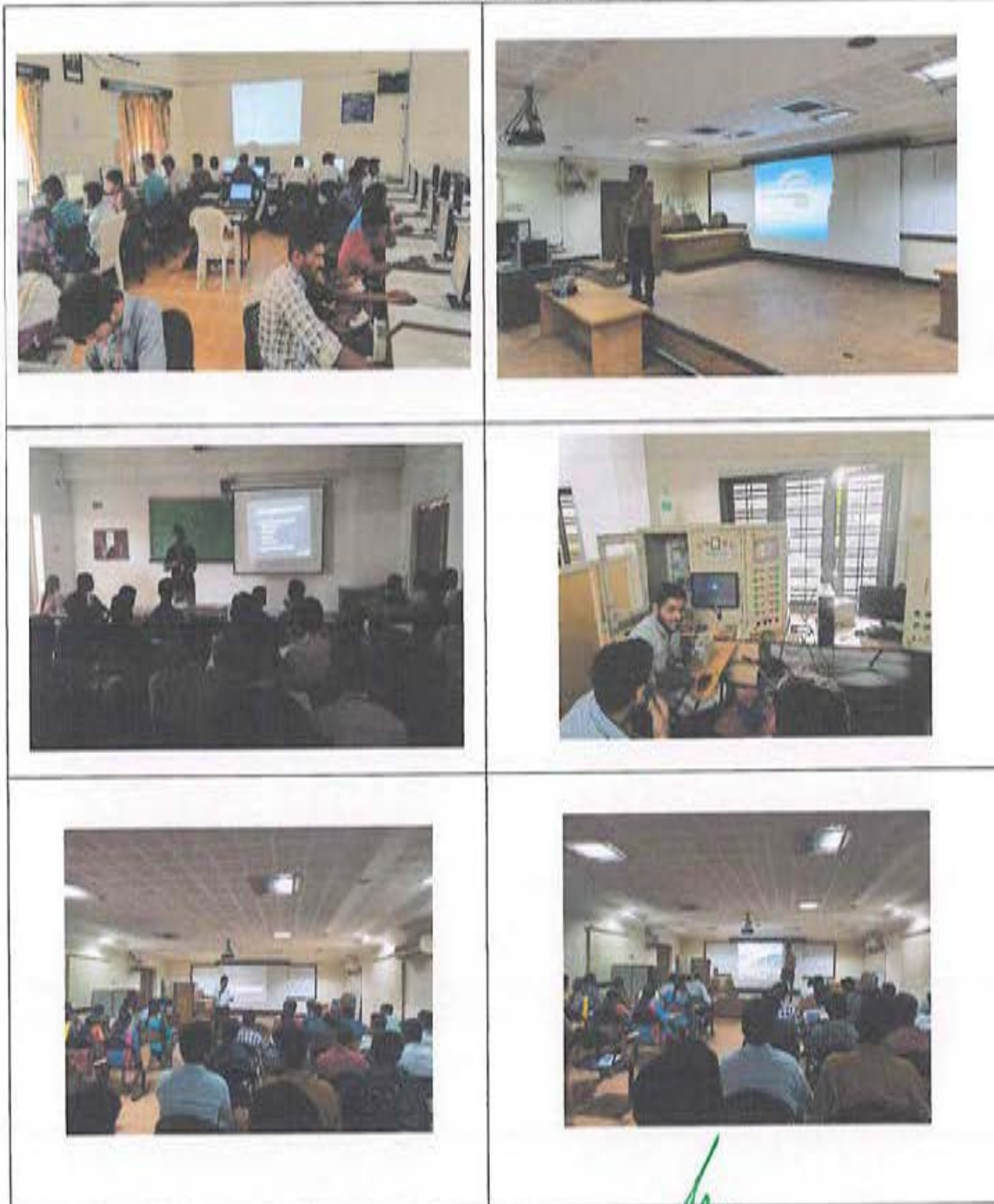

Pragadeep
26/04/2022
Course Coordinator
Dr. P. Ramasamy



PRINCIPAL
K.S.R.COLLEGE OF ENGINEERING
K.S.R. Kalvi Nagar, Tiruchengode-637 215
Namakkal Dist., Tamilnadu

HOD/EEE

Value Added Course on Programmable Logic Controller (PLC)

19th April 2022 to 22nd April 2022

Mohammed Feroed
Project Engineer
IPCS Global Solutions Private Limited
Salem - 636004

WHAT IS AUTOMATION ?

The term 'AUTOMATION' is derived from the Greek word *automata* which mean-self dictated .

Automation is basically the delegation of human control functions to technical equipment aimed towards achieving

- Higher productivity.
- Superior quality of end product.
- Efficient usage of energy and raw materials.
- Improved safety in working condition

© IPCSB

Why automation?

- To reduce human efforts
- To get maximum efficiency from machine and control them with minimum human effort.
- To reduce complex circuitry of entire system
- To eliminate the high costs associated with inflexible, relay-controlled systems.

© IPCSB

AUTOMATION is now everywhere



© IPCSB

INDUSTRIAL AUTOMATION

It is Automation applied to Industry.
It is the use of advanced systems/techniques to control industrial machinery and processes, reducing the need for human intervention.



Objectives of Industrial Automation

- Improve quality
- Increase rate of production
- Increase efficiency
- Increase safety
- Reduce downtime

[Handwritten Signature]
PRINCIPAL

K.S.R.COLLEGE OF ENGINEERING
K.S.R.Kalvi Nagar, Tiruchengode-637 215
Namakkal Dist., Tamilnadu

History of automation

- Manual control
- Hardwired control
- Electronic control
- Programmable Logic Control

© IPCR

Manual Control

Controlling of a process which is fully depended on humans.



© IPCR

Disadvantages:

- More man power
- Less accuracy
- Less productivity
- More time
- Less efficiency

© IPCR

Hardwired Control

Controlling a process or sequence using different types of switching devices like relays, contactors, timers, counters and control and power circuits is called hardwired control.



© IPCR

Disadvantages

- Bulky wiring
- Difficult to troubleshoot
- Difficult to modify
- Complex
- Maintenance
- Cost



Electronic Control

The drastic development in electronics industry made micro processor and micro controllers that could replace the existing systems in the industry. These systems reduce the space and complexity of control systems in the industry.



© IPCR

PRINCIPAL
K.S.R.COLLEGE OF ENGINEERING
 K.S.R.Kalvi Nagar, Tiruchengode-637 215
 Namakkal Dist., Tamilnadu

Disadvantages:

- Programming difficulty as programming structure incompatible for the industry.
- Not able to with stand high temperatures present in the industry.
- Absence of a common Platforms for communication between devices.
- Get damaged due to electric and magnetic interferences present in the industry.

© IPCB

Relays

Used for designing different control circuits

Relay panels are replaced by modern controller like PLCs

Consists of a coil, Common contact, Normally open contact (NO) Normally close contact (NC)

Classification

1. Based on coil voltage
2. No. of poles
3. Current rating of contacts

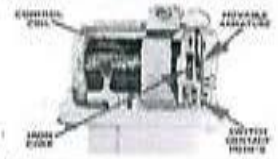

© IPCB

Relay Working

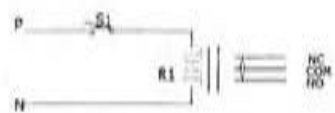

If the relay is switched off NC and Common will be connected, and if relay is switched on the NO and Common will be connected.

© IPCB

Automation System Configuration



© IPCB

Programmable Logic Controllers

- A digitally operating electronic system, designed for use in an industrial environment
- Uses a programmable memory for the internal storage of user-oriented instructions for implementing specific functions such as logic, sequencing, timing, counting and arithmetic, as control, through digital or analog inputs and outputs, various types of machines or processes



PLC History

- PLC: introduced in the late 1960 to replace Relays and Hard-wired Programming.
- In 1970s with the coming of microprocessors and associated peripheral chips, the whole process of control and automation underwent a radical change.
- The programmable controllers have in recent years experienced an unprecedented growth as universal element in Industrial Automation.

© IPCB

PRINCIPAL
K.S.R.COLLEGE OF ENGINEERING
 K.S.R.Kalvi Nagar, Tiruchengode-637 215
 Namakkal Dist., Tamilnadu

Programmable Logic Controllers ADVANTAGES

- COMPACT
- HIGHLY RELIABLE
- MORE FLEXIBILITY
- FASTER RESPONSE TIME
- COMMUNICATION CAPABILITY
like TIMING, COUNTING, PID
Calculations etc
- EASY TROUBLESHOOTING

© IPCR

Anatomy of PLC

- Power Supply Unit
- CPU
- Memory
- Input Module
- Output Module
- Bus System
- Display Unit
- Communication Port

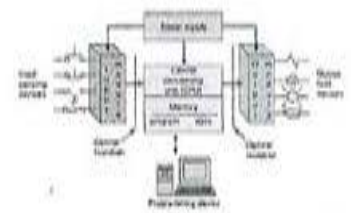

© IPCR

Main Parts of a PLC

Many PLC configurations are available, even from a single vendor. But, in each of these there are common components and concepts. The most essential components are:

Power Supply - This can be built into the PLC or be an external unit. Common voltage levels required by the PLC (with and without the power supply) are 24Vdc, 120Vac, 220Vac.

CPU (Central Processing Unit) - This is a computer where ladder logic is stored and processed.

I/O (Input/Output) - A number of input/output terminals must be provided so that the PLC can monitor the process and initiate actions.

Indicator lights - These indicate the status of the PLC including power on, program running, and a fault. These are essential when diagnosing problems.



© IPCR

PLC inputs & outputs

- Inputs to, and outputs from, a PLC are necessary to monitor and control a process.
- Both inputs and outputs can be categorized into two basic types: **logical** or **continuous**.
- Consider the example of a light bulb. If it can only be turned on or off, **it is logical control**.
- If the light can be dimmed to different levels, **it is continuous**.

© IPCR

More about PLC outputs

- Outputs from PLCs are often relays, but they can also be solid state electronics such as transistors for DC outputs or Triacs for AC outputs.
- Continuous outputs require special output cards with digital to analog converters.



© IPCR

Programming Device

The programming device or terminal, is used to enter the desired program into the memory of the PLC's processor. This program is entered using **Relay Ladder Logic**, which is the most popular programming language used by all manufacturers of PLC.



Programming devices: a) Handheld unit, & b) Personal computer with appropriate software.

© IPCR

PRINCIPAL
K.S.R. COLLEGE OF ENGINEERING
K.S.R. Kalvi Nagar, Tiruchengode-637 215
Namakkal Dist., Tamilnadu

PLC Programming Languages.

1. LADDER DIAGRAM (LAD/LD)
2. STRUCTURED LAD
3. INSTRUCTION LIST (IL)
4. SEQUENTIAL FUNCTION CHART (SFC)
5. FUNCTION BLOCK DIAGRAM (FBD)

© IPCB

PROGRAMMING

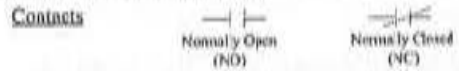

Power flows through these contacts when they conduct. The normally open contact (NO) will conduct when the control bit on the contact is true (1). The normally closed contact (NC) will conduct when the control bit on the contact is false (0).



Coils represent relays that are energized when power flows to them. When a coil is energized it causes the corresponding bit to turn on by changing the state of the status to 1.

© IPCB

Rung Or Network

Each rung or network on a ladder program represents a logic operation



In the above rung, output C is true (1) when input A is high (1).

Boxes

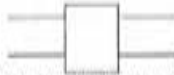

Boxes could represent various instructions or functions that are executed when power flows to the box. Examples are compare instructions, timers, counters and math operations.

© IPCB

AND OPERATION



In the above rung, both inputs A and B must be true (1) in order for the output C to be true (1).

OR OPERATION

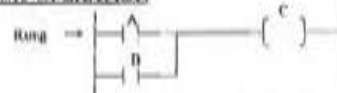

In the above rung, either of the inputs A or B are to be true (1), for the output C to be true (1).

© IPCB

NOT OPERATION



In the above rung, it can be seen that if input A is true (1), then for output C to be true (0) or when A is (0), output C is 1.

PLC PROGRAMMING

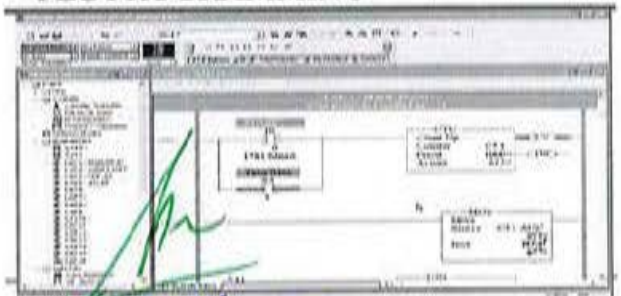

PRINCIPAL
K.S.R. COLLEGE OF ENGINEERING
 K.S.R. Kalvi Nagar, Tiruchengode-637 215
 Namakkal Dist., Tamilnadu



From

R.Veeramani,
Associate Professor/ECE,
K.S.R. College of Engineering,
Tiruchengode-637 215.

To

The Principal,
K.S.R College of Engineering,
Tiruchengode-637 215.

Respected Sir,

Sub: Value added course on "**Smart Phone Learning and Troubleshooting**" for second year ECE students - Permission-Reg.,

Our department has planned to conduct a value added course on "**Smart Phone Learning and Troubleshooting**" for our second year students from **23.05.2022 to 26.05.2022**. Kindly provide us permission to conduct the above course at our department.

Course Schedule:

Course duration: 4 Days

Approximate number of students: 90

Venue: Seminar Hall, Main Block and EDC Lab

Thanking you,

Place: Tiruchengode,
Date: 16.05.2022

Yours faithfully,

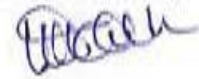

(R.Veeramani)
(J.Rameshkumar)

Forwarded to principal

pr
PRINCIPAL
K.S.R.COLLEGE OF ENGINEERING
K.S.R.Kalvi Nagar, Tiruchengode-637-215
Namakkal Dist., Tamilnadu



K.S.R. COLLEGE OF ENGINEERING (Autonomous): TIRUCHENGODE - 637 215

Date: 16.05.2022

Time: 10.00 a.m.

CIRCULAR

Classification	ROUTINE ✓	IMMEDIATE
ORIGINATOR:HOD- ECE		CIRCULATED TO: B.E.(ECE) II Year

Sub:VALUE ADDED COURSE 2021-22- Reg.

There will be a Value Added Course for B.E.(ECE)- II Year on topic of "Smart Phone Learning and Troubleshooting" from 23.05.2022 to 26.05.2022, Time 09.00am- 04.00 pm at EDC Lab. All the registered students are asked to attend the course without fail.

Instructions to the students through Course Coordinator

1. Dress Code (Self Grooming, Formal wear with shoes)
2. Discipline and attendance is compulsory to attend the program.
3. Punctuality

If any student not follows the above he/she may not be allowed to proceed further.

HoD / ECE



PRINCIPAL
K.S.R. COLLEGE OF ENGINEERING
K.S.R. KALVI NAGAR,
TIRUCHENGODE-637 215

K.S.R. COLLEGE OF ENGINEERING (AUTONOMOUS), TIRUCHENGODE – 637 215

DEPARTMENT OF ECE

Value Added Course on IE (I) Sponsored "Smart Phone Learning and Troubleshooting"

ATTENDANCE

Date: 23.05.2022

S.No	Reg.No	STUDENT NAME	YEAR & SECTION	23/05	24/05	25/05	26/06
1.	2015001	ANANDHA PRAKASH R	II A	/	/	/	/
2.	2015002	BALAJI S	II A	/	/	/	/
3.	2015003	DHANRAAJ S	II A	/	/	/	/
4.	2015004	GIRIDHARAN P	II A	/	/	/	/
5.	2015005	GOKUL K	II A	/	/	/	/
6.	2015006	GOWTHAM M	II A	/	/	/	/
7.	2015007	HARIISH R S	II A	/	/	/	/
8.	2015008	HARISH V	II A	/	/	/	/
9.	2015009	HEMANTH KUMAR M	II A	/	/	/	/
10.	2015010	JAICHANDRU S	II A	/	A	/	/
11.	2015011	JAYAPRAKASH R	II A	/	/	/	/
12.	2015012	JAYAPRAVINRAJ R	II A	/	/	/	/
13.	2015013	JEEVA R	II A	/	/	/	/
14.	2015014	JEEVANANTHAM P	II A	/	/	/	/
15.	2015015	JEEVANANTHAM P	II A	/	/	/	/
16.	2015016	JINU R	II A	/	/	/	/
17.	2015017	KAMALESHKANNA P	II A	/	/	/	/
18.	2015018	KARTHICK RAJA P	II A	/	/	/	/
19.	2015019	KARTHIGADEVI T	II A	/	/	/	/
20.	2015020	KATHIRVEL R	II A	/	/	/	/
21.	2015021	KIRUTHIKA D	II A	/	/	/	/
22.	2015022	LOGESH S	II A	/	/	/	/
23.	2015023	MAHAA SHURUTHY G	II A	/	/	/	/
24.	2015025	MANOBALA S	II A	/	/	/	/
25.	2015027	MOHANKUMAR GV	II A	/	/	/	/
26.	2015028	NAVACHITHU PONKUMAR D	II A	/	/	/	/
27.	2015029	PANDISELVI P	II A	/	/	/	/
28.	2015030	PERIYASAMY S	II A	/	/	/	/
29.	2015031	PRADEEP R	II A	/	/	/	/
30.	2015032	PRAVEENKUMAR R	II A	/	/	/	/
31.	2015501	AJITHKUMAR S	II A	/	/	A	/
32.	2015502	BALAJI M	II A	/	/	/	/
33.	2015504	GOKULRAM S	II A	/	/	/	/
34.	2015505	HARI RAJ R	II A	/	/	/	/
35.	2015506	JAGAN S	II A	/	/	/	/
36.	2015507	JAGAN S	II A	/	A	/	/
37.	2015508	JAWAHAR M	II A	/	/	/	/
38.	2015509	JAYANTH S	II A	/	/	/	/
39.	2015510	JAYASURYA A	II A	/	/	/	A
40.	2015511	JEEVA P	II A	/	/	/	/
41.	2015512	JEGANATH T	II A	/	/	/	/
42.	2015513	KARTHICK S	II A	/	/	/	/
43.	2015515	LOGA DEEPAK K U	II A	/	/	/	/
44.	2015517	MANIKANDAN P	II A	/	/	/	/
45.	2015033	PRAVEENKUMAR R	II B	/	/	/	/
46.	2015034	PUGAZHENTHI V	II B	/	/	/	/
47.	2015035	RAJA SRI B	II B	/	/	/	/
48.	2015036	RAMYA S S	II B	/	/	/	/
49.	2015037	RISHIKESAN R	II B	/	/	/	/
50.	2015038	SABARI S	II B	/	/	/	/
51.	2015039	SANGAVI S	II B	/	/	/	/
52.	2015040	SANJAY L	II B	/	/	/	/

53.	2015041	SANTHIYA N	II B	/	/	/	/
54.	2015042	SANTHOSH K	II B	/	/	/	/
55.	2015043	SARAN C	II B	/	/	/	/
56.	2015044	SARAVANAN R	II B	/	/	/	/
57.	2015046	SHANJEVI M	II B	/	/	/	A
58.	2015047	SIVAKUMAR M	II B	/	/	/	/
59.	2015048	SNEKA GP	II B	/	/	/	/
60.	2015049	SRI KOWSIKA V	II B	/	/	/	/
61.	2015050	SRI SABHARISH S	II B	/	/	/	/
62.	2015051	SRIDHARAN J	II B	/	/	/	/
63.	2015052	SRIVIDHYA A	II B	/	/	/	/
64.	2015053	SUBASH M	II B	/	/	/	/
65.	2015054	SUDHAKAR S	II B	/	/	/	/
66.	2015055	SUDHAKAR N	II B	/	/	/	/
67.	2015056	SUDHARSAN R	II B	/	/	A	/
68.	2015057	SURIYA P	II B	/	/	/	/
69.	2015058	SURUTHI K	II B	/	/	/	/
70.	2015059	SURYA V	II B	/	/	/	/
71.	2015060	SUVITHA M	II B	/	/	/	/
72.	2015061	VAISHNAVI M	II B	/	/	/	/
73.	2015062	VAISHNAVI V	II B	/	/	/	/
74.	2015063	VIGNESH A	II B	/	/	/	/
75.	2015516	LOGESH P	II B	/	A	/	/
76.	2015518	MANJU R	II B	/	/	/	/
77.	2015519	MATHIYAZHAGAN D	II B	/	/	/	/
78.	2015520	MUGUNTHAN R	II B	/	/	/	/
79.	2015521	MUKUNTHAN M	II B	/	/	/	/
80.	2015522	NARESH KUMAR S	II B	/	/	/	/
81.	2015523	NAVEENKUMAR S	II B	/	/	/	/
82.	2015524	PCOVARASAN C	II B	A	/	/	/
83.	2015525	PRADEEP KUMAR M	II B	/	/	/	/
84.	2015526	PRANESH S	II B	/	/	/	/
85.	2015527	PRASAD T	II B	/	/	/	/
86.	2015528	RANJITH G	II B	/	/	/	/
87.	2015529	SAKTHI R	II B	/	/	/	/
88.	2015530	SATHISHKUMAR G	II B	/	/	/	/
89.	2015531	SUBASH M	II B	/	/	/	/
90.	2015532	YASUDHIN U	II B	/	/	/	/

COURSE CO-ORDINATOR

HOD-ECE



PRINCIPAL
K.S.R. COLLEGE OF ENGINEERING
K.S.R. KALVI NAGAR,
TIRUCHENGODE-637 215

K.S.R. COLLEGE OF ENGINEERING (AUTONOMOUS), TIRUCHENGODE - 637 215

DEPARTMENT OF ECE

Academic Year 2021-22

Value Added Course on IE (I) Sponsored value added course on "Smart Phone Learning and Troubleshooting"

Course Contents

Date: 16.05.2022

- Basics of mobile communication.
- Study of various tools and equipment used in mobile phone repairs.
- Assembling and disassembling of various models of mobile phones.
- Study of parts inside a mobile phone.
- Use of DC Power Supply
- Introduction and study of Printed Circuit Board (Motherboard).
- Details of various components on the PCB.
- Testing of various parts and components.
- Study of different ICs (chips) used on the motherboard.
- How to recognize various ICs.
- Soldering & desoldering of components by using a soldering iron.
- Detailed study of various faults arising due to corrupt software.
- Introduction of various flasher boxes and software.
- Flashing of various brands of handsets.
- Removing virus from infected phones.
- Unlocking of handsets through codes and/or software.



Course Coordinator



HOD /ECE



PRINCIPAL

**K.S.R. COLLEGE OF ENGINEERING
K.S.R. Kalvi Nagar, Tiruchengode-637 215
Namakkal Dist., Tamilnadu**

K.S.R. COLLEGE OF ENGINEERING (AUTONOMOUS), TIRUCHENGODE - 637 215

DEPARTMENT OF ECE

Academic Year 2021-22

Value Added Course on "IE (I) Sponsored value added course on "Smart Phone Learning and Troubleshooting"

Course Outcomes

Date: 26.05.2022

At the end of the training, the trainee will be able to

- Appreciate the importance of embarking on self-employment and has developed the confidence.
- Identify business opportunities in chosen sector / sub-sector and plan and market and sell.
- Repair and Diagnose the Problem of all kinds of faults in Mobile Phone handsets in Hardware as well Software and rectify the faults using tools and equipment and various software.
- Use appropriate tools, spares and software updates, conduct test for repairs,
- Ensure admittance of faulty handsets, prioritize and conduct repair activities in time.



COURSE CO-ORDINATOR



HOD-ECE

26.05.22



PRINCIPAL

K.S.R. COLLEGE OF ENGINEERING
K.S.R. Kalvi Nagar, Tiruchengode-637 215
Namakkal Dist., Tamilnadu

K.S.R. COLLEGE OF ENGINEERING (AUTONOMOUS), TIRUCHENGODE - 637 215

DEPARTMENT OF ECE

Academic Year 2021-22

Value Added Course on IE (I) Sponsored value added course on "Smart Phone Learning and Troubleshooting"FEEDBACK FORM

Kindly provide your valuable feedback about this value added course to course to improve the quality in future.

Name of the Student : G. Rangitha

Register No. : 2015528

Kindly evaluate in the following scale by ticking on the relevant grade.

1. Excellent 2. Good 3. Satisfactory 4. Poor

Description	Excellent	Good	Satisfactory	Poor
The course as a whole was:		✓		
The course content was:	✓			
The instructor's contribution to the course was:	✓			
The instructor's effectiveness in teaching the subject matter was:	✓			
Explanations by instructor were:		✓		
Encouragement given to students to participate was:	✓			
Amount you learned was:		✓		
Relevance of course content was:		✓		
Amount of assigned work was:	✓			



[Signature]
 PRINCIPAL
 K.S.R. COLLEGE OF ENGINEERING
 K.S.R. Kalvi Nagar, Tiruchengode-637 215
 Namakkal Dist., Tamilnadu

[Signature]
 Signature

K.S.R. COLLEGE OF ENGINEERING (AUTONOMOUS), TIRUCHENGODE - 637 215

DEPARTMENT OF ECE

Academic Year 2021-22

Value Added Course on IE (I) Sponsored value added course on "Smart Phone Learning and Troubleshooting"FEEDBACK FORM

Kindly provide your valuable feedback about this value added course to course to improve the quality in future.

Name of the Student : R. Mugunthan

Register No. : 2015520

Kindly evaluate in the following scale by ticking on the relevant grade.

1. Excellent 2. Good 3. Satisfactory 4. Poor

Description	Excellent	Good	Satisfactory	Poor
The course as a whole was:			✓	
The course content was:	✓			
The instructor's contribution to the course was:	✓			
The instructor's effectiveness in teaching the subject matter was:	✓			
Explanations by instructor were:		✓		
Encouragement given to students to participate was:	✓			
Amount you learned was:		✓		
Relevance of course content was:			✓	
Amount of assigned work was:	✓			



 PRINCIPAL
 K.S.R. COLLEGE OF ENGINEERING
 K.S.R. Kalvi Nagar, Tiruchengode-637 215
 Namakkal Dist., Tamilnadu

Signature: 

K.S.R. COLLEGE OF ENGINEERING (AUTONOMOUS), TIRUCHENGODE - 637 215

DEPARTMENT OF ECE

Academic Year 2021-22

Value Added Course on IE (I) Sponsored value added course on "Smart Phone Learning and Troubleshooting"**FEEDBACK FORM**

Kindly provide your valuable feedback about this value added course to course to improve the quality in future.

Name of the Student : R.SARAVANAN

Register No. : 2015044

Kindly evaluate in the following scale by ticking on the relevant grade.

1. Excellent 2. Good 3. Satisfactory 4. Poor

Description	Excellent	Good	Satisfactory	Poor
The course as a whole was:	✓			
The course content was:	✓			
The instructor's contribution to the course was:	✓			
The instructor's effectiveness in teaching the subject matter was:		✓		
Explanations by instructor were:		✓		
Encouragement given to students to participate was:		✓		
Amount you learned was:			✓	
Relevance of course content was:		✓		
Amount of assigned work was:			✓	



Date: 15.05.2022

PRINCIPAL

K.S.R. COLLEGE OF ENGINEERING
K.S.R. Kalvi Nagar, Tiruchengode-637 215
Namakkal Dist., Tamilnadu

Signature

K.S.R. COLLEGE OF ENGINEERING (AUTONOMOUS), TIRUCHENGODE - 637 215

DEPARTMENT OF ECE

Academic Year 2021-22

Value Added Course on IE (I) Sponsored value added course on "Smart Phone Learning and Troubleshooting"FEEDBACK FORM

Kindly provide your valuable feedback about this value added course to course to improve the quality in future.

Name of the Student : K. Gokul

Register No. : 2015005

Kindly evaluate in the following scale by ticking on the relevant grade.

1. Excellent 2. Good 3. Satisfactory 4. Poor

Description	Excellent	Good	Satisfactory	Poor
The course as a whole was:	✓			
The course content was:		✓		
The instructor's contribution to the course was:		✓		
The instructor's effectiveness in teaching the subject matter was:	✓			
Explanations by instructor were:	✓			
Encouragement given to students to participate was:		✓		
Amount you learned was:		✓		
Relevance of course content was:	✓			
Amount of assigned work was:			✓	

Date: 5.2.2022



PRINCIPAL

K.S.R. COLLEGE OF ENGINEERING
K.S.R. Kalvi Nagar, Tiruchengode-637 215
Namakkal Dist., Tamilnadu

Signature

K.S.R. COLLEGE OF ENGINEERING (AUTONOMOUS), TIRUCHENGODE - 637 215

DEPARTMENT OF ECE

Academic Year 2021-22

Value Added Course on IE (I) Sponsored value added course on "Smart Phone Learning and Troubleshooting"FEEDBACK FORM

Kindly provide your valuable feedback about this value added course to course to improve the quality in future.

Name of the Student : SRIVIDHYA A

Register No. : 2015052

Kindly evaluate in the following scale by ticking on the relevant grade.

1. Excellent 2. Good 3. Satisfactory 4. Poor

Description	Excellent	Good	Satisfactory	Poor
The course as a whole was:		✓		
The course content was:		✓		
The instructor's contribution to the course was:	✓			
The instructor's effectiveness in teaching the subject matter was:		✓		
Explanations by instructor were:	✓			
Encouragement given to students to participate was:		✓		
Amount you learned was:		✓		
Relevance of course content was:		✓		
Amount of assigned work was:			✓	

Date: 26.05.2022



Signature

PRINCIPAL
K.S.R. COLLEGE OF ENGINEERING
K.S.R. Kalvi Nagar, Tiruchengode-637 215
Namakkal Dist., Tamilnadu

K.S.R. COLLEGE OF ENGINEERING (AUTONOMOUS), TIRUCHENGODE - 637 215

DEPARTMENT OF ECE

Academic Year 2021-22

Value Added Course on IE (I) Sponsored value added course on "Smart Phone Learning and Troubleshooting"**FEEDBACK FORM**

Kindly provide your valuable feedback about this value added course to course to improve the quality in future.

Name of the Student : U. YASUDHIN

Register No. : 2015532

Kindly evaluate in the following scale by ticking on the relevant grade.

1. Excellent 2. Good 3. Satisfactory 4. Poor

Description	Excellent	Good	Satisfactory	Poor
The course as a whole was:	✓			
The course content was:		✓		
The instructor's contribution to the course was:	✓	✓		
The instructor's effectiveness in teaching the subject matter was:	✓			
Explanations by instructor were:	✓			
Encouragement given to students to participate was:	✓			
Amount you learned was:	✓			
Relevance of course content was:	✓			
Amount of assigned work was:	✓			



05.05.2022

PRINCIPAL

K.S.R. COLLEGE OF ENGINEERING
K.S.R. Kalvi Nagar, Tiruchengode-637 215
Namakkal Dist., Tamilnadu

Signature

K.S.R. COLLEGE OF ENGINEERING (AUTONOMOUS), TIRUCHENGODE - 637 215

DEPARTMENT OF ECE

Academic Year 2021-22

Value Added Course on IE (I) Sponsored value added course on "Smart Phone Learning and Troubleshooting"FEEDBACK FORM

Kindly provide your valuable feedback about this value added course to course to improve the quality in future.

Name of the Student : R. Praveenkumar

Register No. : 2015033

Kindly evaluate in the following scale by ticking on the relevant grade.

1. Excellent 2. Good 3. Satisfactory 4. Poor

Description	Excellent	Good	Satisfactory	Poor
The course as a whole was:	✓		✓	
The course content was:		✓		
The instructor's contribution to the course was:	✓			
The instructor's effectiveness in teaching the subject matter was:		✓		
Explanations by instructor were:	✓			
Encouragement given to students to participate was:	✓			
Amount you learned was:			✓	
Relevance of course content was:	✓			
Amount of assigned work was:		✓		



R. Praveenkumar
Signature

PRINCIPAL

K.S.R. COLLEGE OF ENGINEERING
K.S.R. Kalvi Nagar, Tiruchengode-637 215
Namakkal Dist., Tamilnadu

K.S.R. COLLEGE OF ENGINEERING (AUTONOMOUS), TIRUCHENGODE - 637 215

DEPARTMENT OF ECE

Academic Year 2021-22

Value Added Course on IE (I) Sponsored value added course on "Smart Phone Learning and Troubleshooting"FEEDBACK FORM

Kindly provide your valuable feedback about this value added course to course to improve the quality in future.

Name of the Student : S. Karthick

Register No. : 2015513

Kindly evaluate in the following scale by ticking on the relevant grade.

1. Excellent 2. Good 3. Satisfactory 4. Poor

Description	Excellent	Good	Satisfactory	Poor
The course as a whole was:	✓			
The course content was:			✓	
The instructor's contribution to the course was:	✓			
The instructor's effectiveness in teaching the subject matter was:		✓		
Explanations by instructor were:	✓			
Encouragement given to students to participate was:			✓	
Amount you learned was:	✓			
Relevance of course content was:		✓		
Amount of assigned work was:	✓			

Date: 15/5/2022



Signature

PRINCIPAL
K.S.R. COLLEGE OF ENGINEERING
K.S.R. Kalvi Nagar, Tiruchengode-637 215
Namakkal Dist., Tamilnadu

K.S.R. COLLEGE OF ENGINEERING (AUTONOMOUS), TIRUCHENGODE - 637 215

DEPARTMENT OF ECE

Academic Year 2021-22

Value Added Course on IE (I) Sponsored value added course on "Smart Phone Learning and Troubleshooting"FEEDBACK FORM

Kindly provide your valuable feedback about this value added course to course to improve the quality in future.

Name of the Student : S. JAGAN

Register No. : 2015506

Kindly evaluate in the following scale by ticking on the relevant grade.

1. Excellent 2. Good 3. Satisfactory 4. Poor

Description	Excellent	Good	Satisfactory	Poor
The course as a whole was:	✓			
The course content was:		✓		
The instructor's contribution to the course was:			✓	
The instructor's effectiveness in teaching the subject matter was:	✓			
Explanations by instructor were:		✓		
Encouragement given to students to participate was:			✓	
Amount you learned was:	✓			
Relevance of course content was:		✓		
Amount of assigned work was:			✓	



PRINCIPAL

K.S.R. COLLEGE OF ENGINEERING
K.S.R. Kalvi Nagar, Tiruchengode-637 215
Namakkal Dist., Tamilnadu

Signature

K.S.R. COLLEGE OF ENGINEERING (AUTONOMOUS), TIRUCHENGODE - 637 215

DEPARTMENT OF ECE

Academic Year 2021-22

Value Added Course on IE (I) Sponsored value added course on "Smart Phone Learning and Troubleshooting"FEEDBACK FORM

Kindly provide your valuable feedback about this value added course to course to improve the quality in future.

Name of the Student : *V. Vaishnavi*Register No. : *2015062*

Kindly evaluate in the following scale by ticking on the relevant grade.

1. Excellent 2. Good 3. Satisfactory 4. Poor

Description	Excellent	Good	Satisfactory	Poor
The course as a whole was:	✓			
The course content was:		✓		
The instructor's contribution to the course was:		✓		
The instructor's effectiveness in teaching the subject matter was:	✓			
Explanations by instructor were:	✓			
Encouragement given to students to participate was:	✓			
Amount you learned was:		✓		
Relevance of course content was:	✓			
Amount of assigned work was:	✓			



Date:

6/05/2022

V. Vaishnavi
Signature

PRINCIPAL
K.S.R. COLLEGE OF ENGINEERING
K.S.R. Kalvi Nagar, Tiruchengode-637 215
Namakkal Dist., Tamilnadu

K.S.R. COLLEGE OF ENGINEERING (AUTONOMOUS), TIRUCHENGODE - 637 215

DEPARTMENT OF ECE

Academic Year 2021-22

Value Added Course on IE (I) Sponsored value added course on "Smart Phone Learning and Troubleshooting"FEEDBACK FORM

Kindly provide your valuable feedback about this value added course to course to improve the quality in future.

Name of the Student : P. Pandiselvi

Register No. : 2015029

Kindly evaluate in the following scale by ticking on the relevant grade.

1. Excellent 2. Good 3. Satisfactory 4. Poor

Description	Excellent	Good	Satisfactory	Poor
The course as a whole was:	✓			
The course content was:	✓			
The instructor's contribution to the course was:		✓		
The instructor's effectiveness in teaching the subject matter was:	✓			
Explanations by instructor were:			✓	
Encouragement given to students to participate was:		✓		
Amount you learned was:			✓	
Relevance of course content was:	✓			
Amount of assigned work was:			✓	

Date: 16/07/2022



 P. Pandiselvi
Signature

PRINCIPAL

K.S.R. COLLEGE OF ENGINEERING
K.S.R. Kalvi Nagar, Tiruchengode-637 215
Namakkal Dist., Tamil Nadu

K.S.R. COLLEGE OF ENGINEERING (AUTONOMOUS), TIRUCHENGODE - 637 215

DEPARTMENT OF ECE

Academic Year 2021-22

Value Added Course on IE (I) Sponsored value added course on "Smart Phone Learning and Troubleshooting"FEEDBACK FORM

Kindly provide your valuable feedback about this value added course to course to improve the quality in future.

Name of the Student : *S.S.Ramya*Register No. : *2015036*

Kindly evaluate in the following scale by ticking on the relevant grade.

1. Excellent 2. Good 3. Satisfactory 4. Poor

Description	Excellent	Good	Satisfactory	Poor
The course as a whole was:	<input checked="" type="checkbox"/>			
The course content was:		<input checked="" type="checkbox"/>		
The instructor's contribution to the course was:	<input checked="" type="checkbox"/>			
The instructor's effectiveness in teaching the subject matter was:	<input checked="" type="checkbox"/>			
Explanations by instructor were:		<input checked="" type="checkbox"/>		
Encouragement given to students to participate was:	<input checked="" type="checkbox"/>			
Amount you learned was:	<input checked="" type="checkbox"/>			
Relevance of course content was:		<input checked="" type="checkbox"/>		
Amount of assigned work was:	<input checked="" type="checkbox"/>			

Date: *05.2022*

S.S.Ramya
Signature

[Signature]
PRINCIPAL
K.S.R. COLLEGE OF ENGINEERING
K.S.R. Kalvi Nagar, Tiruchengode-637 215
Namakkal Dist., Tamilnadu

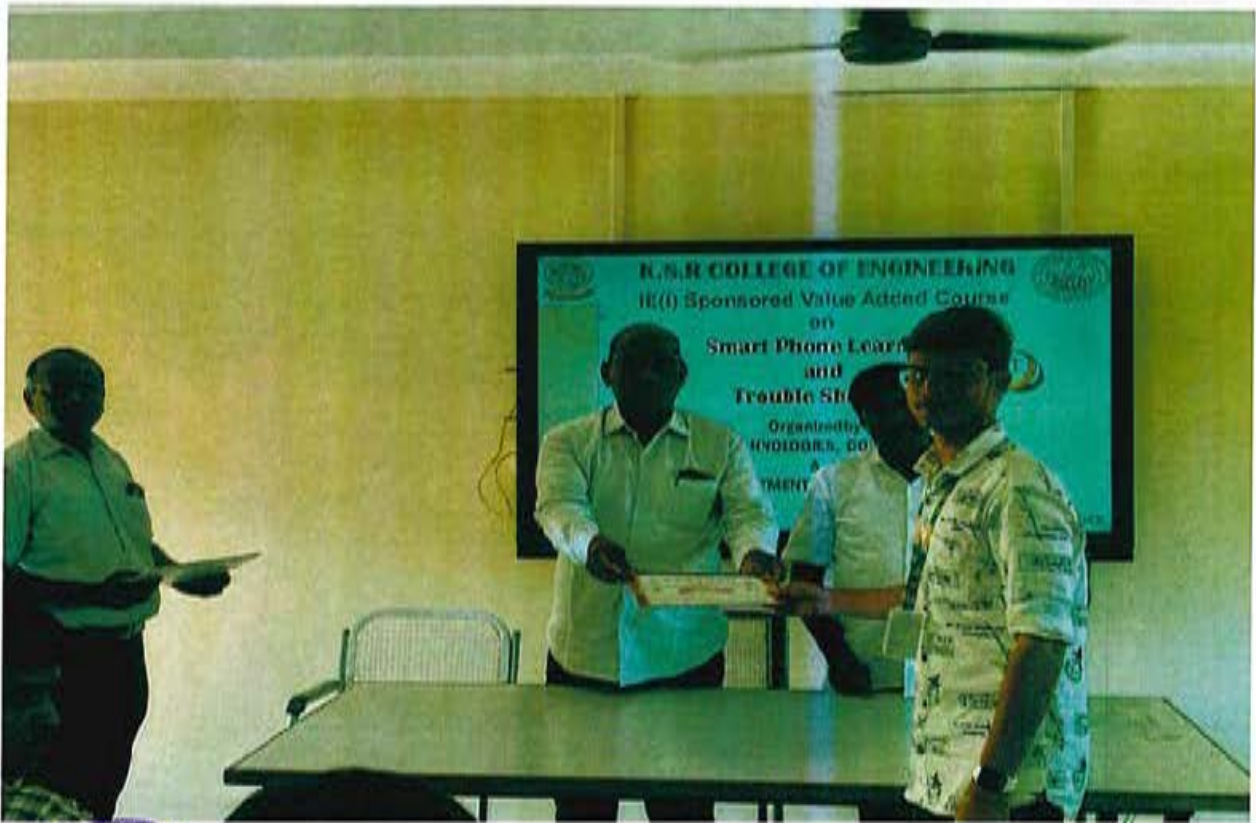



PRINCIPAL
K.S.R. COLLEGE OF ENGINEERING
K.S.R. Kalvi Nagar, Tiruchengode-637 215
Namakkal Dist., Tamilnadu



PRINCIPAL
K.S.R.COLLEGE OF ENGINEERING
K.S.R.Kalvi Nagar, Tiruchengode-637 215
Namakkal Dist., Tamilnadu



PRINCIPAL
K.S.R. COLLEGE OF ENGINEERING
K.S.R. Kalvi Nagar, Tiruchengode-637 215
Namakkal Dist., Tamilnadu



KSR COLLEGE OF ENGINEERING

(Autonomous)

Tiruchencode, Tamilnadu, 637215

Department of Electronics & Communication Engineering

In Association With

NEW TECHNOLOGY MOBILE SERVICE AND TRAINING INSTITUTE, COIMBATORE - 641005

An ISO 9001-2015 Certified Institute



AJCTE Certified Institute (University)



This is to certify that Mr./Ms.SANGAVI.S..... ii. ECE..... of
KSR COLLEGE OF ENGINEERING has attended a one credit course on "SMART PHONE
LEARNING & TROUBLE SHOOTING" from 23.05.2022 to 26.05.2022 organized by The Institution
of Engineers (India) & Department of Electronics and Communication Engineering.

HOD-ECE

HOD-ECE

PRINCIPAL
K.S.R.COLLEGE OF ENGINEERING
K.S.R.Kalvi Nagar, Tiruchengode-637 215
Namakkal Dist., Tamilnadu



From

M.Jothimani

Assistant Professor/ECE,

K.S.R. College of Engineering,

Tiruchengode-637 215.

To

The Principal,

K.S.R College of Engineering,

Tiruchengode-637 215.

Respected Sir,

Sub: Value added course on **"Hands on Programming Languages in C"** for First Year ECE students - Permission-Reg.,

Our department has planned to conduct a value-added course on **"Hands on Programming Languages in C"** for our first-year students from 04.04.2022 to 30.05.2022. Kindly provide us permission to conduct the above course at our department.

Course Schedule:

Course duration: 45 Hours

Approximate number of students: 47

Venue: VLSI Lab, A-Block, KSRCE

Thanking you,

Place: Tiruchengode,

Date: 28.03.2022



forwarded
Account
28/3/22

PRINCIPAL

K.S.R. COLLEGE OF ENGINEERING
K.S.R. Nagar, Tiruchengode-
Namakkal Dist., Tamil Nadu

Yours faithfully,

M.Jothimani
(M.Jothimani)

K.S.R. COLLEGE OF ENGINEERING (Autonomous): TIRUCHENGODE - 637 215

Date: 28.03.2022

Time: 10.00 a.m.

CIRCULAR

Classification	ROUTINE ✓	IMMEDIATE
ORIGINATOR:HOD- ECE		CIRCULATED TO: B.E.(ECE) I Year

Sub:VALUE ADDED COURSE 2021-2022- Reg.

There will be a Value Added Course for B.E.(ECE)- I Year on topic of "Hands on Programming Language in C" from 04.04.2022 to 30.05.2022, Time 03.00pm- 04.30 pm at VLSI Lab. All the registered students are asked to attend the course without fail.

Note : Maximum of Register Capacity: 50 Students

Instructions to the students through Course Coordinator

1. Dress Code (Self Grooming, Formal wear with shoes)
2. Discipline and attendance is compulsory to attend the program.
3. Punctuality

If any student not follows the above he/she may not be allowed to proceed further.



 PRINCIPAL
 K.S.R. COLLEGE OF ENGINEERING
 K.S.R. KALVI NAGAR,
 TIRUCHENGODE-637,215

 HoD / ECE

K.S.R. COLLEGE OF ENGINEERING, TIRUCHENGODE – 637 215
(AUTONOMOUS)

Department of Electronics and Communication Engineering
Academic Year : 2021-22
STUDENT NAME LIST

Year / Semester: I / II

BATCH: 2021-2025

S.NO	Roll No.	Reg. Number	Name of the Student
1.	21EC001	73152115001	ABHIRAMI DEVI K R
2.	21EC002	73152115002	ADHISANKAR K
3.	21EC004	73152115004	AKASH R
4.	21EC005	73152115005	AMEER SHERIFF R
5.	21EC006	73152115006	ANUKEERTHANA T
6.	21EC007	73152115007	BARANI C
7.	21EC008	73152115008	DEEPAK D
8.	21EC010	73152115010	DHANUJA R
9.	21EC012	73152115012	DHANUSHIYA S
10.	21EC014	73152115014	DHARANI A C
11.	21EC015	73152115015	DHARSHNI K M
12.	21EC020	73152115020	GIRI VELAVAN N
13.	21EC022	73152115022	GOKUL S
14.	21EC023	73152115023	GOPALAKRISHNAN S
15.	21EC025	73152115025	GOWRE PREYA G P
16.	21EC028	73152115028	HARIPRASANTH S
17.	21EC029	73152115029	HARISH A
18.	21EC030	73152115030	INDRAKUMAR U
19.	21EC033	73152115033	JEEVANANTHAM R
20.	21EC034	73152115034	JHANANI K K
21.	21EC036	73152115036	KARTHIKEYAN E
22.	21EC038	73152115038	KAVINRAJ D
23.	21EC042	73152115042	KUMARESAN K
24.	21EC043	73152115043	LAVANYA C
25.	21EC044	73152115044	LOGUPRASATH P
26.	21EC045	73152115045	MADHUMITHA S
27.	21EC046	73152115046	MAHALAKSHMI S
28.	21EC048	73152115048	MANIKANDAN S J
29.	21EC049	73152115049	MANJU M
30.	21EC050	73152115050	MEITHURU PRAKASH B
31.	21EC053	73152115054	NAVEENA E
32.	21EC057	73152115057	PRADEEPIKA M
33.	21EC059	73152115059	PRAVEENKUMAR B
34.	21EC060	73152115060	PRAVIN D
35.	21EC064	73152115064	SANGARA GOMATHI S
36.	21EC071	73152115071	SOWMIYA K
37.	21EC073	73152115073	SRIKANTH E M
38.	21EC074	73152115074	SRINIVASAN V
39.	21EC076	73152115076	SURYA M
40.	21EC077	73152115077	SURYA S
41.	21EC078	73152115078	SWETHA D
42.	21EC079	73152115079	THARUN N
43.	21EC080	73152115080	UDHIKA V
44.	21EC081	73152115081	VARSHA T
45.	21EC088	73152115088	VIGNESHWARAN M
46.	21EC091	73152115091	VINOTHINI E
47.	21EC093	73152115093	YASVANTHIKA K



M. S. S. S.
Course In-charge

PRINCIPAL
K.S.R. COLLEGE OF ENGINEERING
K.S.R. Kalvi Nagar, Tiruchengode 637 215
Nagakkal Dist., Tamilnadu
Page 2 of 3

[Signature]
HOD/ECE

[Signature]

Schedule of the Value Added Course:

Days	Topic
Week -1	Basic concepts in a C program, Declaration, Assignment & Print statements, Data Types, operators and expressions etc, Programming examples and exercise.
Week -2	Two way selection (if, if-else, nested if-else, cascaded if-else), switch statement, ternary operator? Go to
Week -3	Loops (For, while-do, do-while) in C, break and continue, Programming examples and exercises
Week -4	Functions in C, Argument Passing – call by value, call by reference, void and parameter less Functions
Week -5	Programming exercises
Week -6	Recursion, Using an array, Using arrays with Functions
Week -7	Multi-Dimensional arrays, Operations on matrices
Week -8	String: Declaring, Initializing, Printing and reading strings, string manipulation functions, String input and output functions
Week -9	Pointers and address, pointers and functions (call by reference) arguments, pointers and arrays,
Week -10	Address arithmetic, Dynamic memory allocations methods



- The method of instruction followed for most of the sessions is activity based wherein students had to execute the programs which were instructed to understand them properly.



PRINCIPAL
K.S.R.COLLEGE OF ENGINEERING
K.S.R.Kalvi Nagar, Tiruchengode-637 219
Nagercoil, Tamilnadu

[Handwritten Signature]
HOD/EEG

KSRCE/IQAC/2021-22/P&T/IC30-64/ECE

K.S.R. COLLEGE OF ENGINEERING (AUTONOMOUS), TIRUCHENGODE – 637 215
DEPARTMENT OF ECE

Value Added Course on “Hands on Programming Language in C” (2021-2022)

Course Outcomes

Date: 30.05.2022

Upon successful completion of the course, the learner will be able to:

- Comprehend the given problem and develop algorithms for solving them.
- Express solutions to computer oriented problems using flowchart or pseudo code.
- Transform designs of problem solutions into C programming language.
- Write, compile and execute C programs on a IDE.
- Apply debugging and testing techniques to find and resolve errors.
- Write modular code using functions.



COURSE CO-ORDINATOR



HOD-ECE





PRINCIPAL

K.S.R. COLLEGE OF ENGINEERING
K.S.R. Kalvi Nagar, Tiruchengode-637 215
Namakkal Dist., Tamilnadu

K.S.R. COLLEGE OF ENGINEERING, TIRUCHENGODE – 637 215.**(AUTONOMOUS)****DEPARTMENT OF COMPUTER SCIENCE AND ENGINEERING****FACULTY PROFILE**

01. Name : Muthukumaran K
 02. Designation : Assistant Professor
 03. Date of Birth : 18/06/1979
 04. Date of Joining : 02/06/2010
 05. Qualification :



S. No.	Name of the Degree	Specialization	Name of the Institution / University	Name of the University	Year of		Class & % of Marks
					Admitted	Completed	
1	M.E	CSE	Anna University	Anna University - Coimbatore	2007	2009	I & 79%
2.	B.Tech	IT	Mahendra Engineering College	Anna University - Chennai	2002	2005	I & 67%

06. Experience, Promotion & Designation Details (Chronological):**a. Teaching**

S. No.	Name of the Institution	Designation	Nature of work	Period	
				From	To
1.	J.K.K. Munirajah College of Technology	Lecturer	Teaching	24-07-2009	08-05-2010
2.	K.S.R. College of Engineering	Lecturer	Teaching	02.06.2010	30.6.2010
3.	K.S.R. College of Engineering	Assistant Professor	Teaching	01.07.2010	Till Date
Total year of Experience(s)				10 Years 6 Months	

b. Industry

Sl. No.	Name of the Organization	Designation	Nature of work	Period	
				From	To
-	-	-	-	-	-
Total year of Experience(s)				0 Yrs.	

**PRINCIPAL**

K.S.R. COLLEGE OF ENGINEERING
 K.S.R. Kalvi Nagar, Tiruchengode-637 215
 Namakkal Dist., Tamilnadu

06. Journal Publication Detail

S. No.	Title of the Paper	Publication Date	Authors Name	Journal Name	Volume No	Issue No	Pages
1	Demand-Supply Oriented Taxi Suggestion System for Vehicular Social Networks with Real Time Charging Advisor	2019	Mr.K.Muthukumar	International Journal of Engineering Research & Technology (IJERT)	7	1	1-5
2	Cancer Cell Detection Using Mathematical Morphology	2019	Mr.K.Muthukumar	International Journal of Innovative Research in Computer and Communication Engineering	2	1	3717-3725
3	Enable Central Keyword Base Semantic Search Using User Level Encryption Extension Model	2018	K. Muthukumar, G.S. Rizwana Banu,	Journal on Science Engineering and Technology	5	1	85-89

07. Details of Winter/Summer Schools Attended (all faculty enrichment programme)

S. No.	Name of the programme	Organized by	Date & Duration
1	Enterprise Computing	AICTE-SONA College of Technology, Salem	18-04-2011 to 30-04-2011 (13)
2	Enterprise Solutions for Web Applications	MHRD-CDAC-Hyderabad	28-05-2012 to 08-06-2012 (12)
3	Digital Skills Readiness Program	WIPRO Limited, Bangalore	23-05-2016 to 03-06-2016 (12)

08. Details of Workshops/ Seminars Attended

S. No	Name of the programme	Organized by	Date & Duration
1	Data Structure and Algorithms	Sri Shakthi Institute of Engineering and Technology	19-02-2010 (1)
2	Faculty Development Programme	K.S.R. College of Engineering	21-09-2010 to 23-09-2010 (3)
3	Component Based Technology	Sathyabama University	24-02-2011 to 25-02-2011 (2)
4	Data Structure using C	Paavai Engineering College	21-10-2011 to 22-10-2011 (2)
5	J2SE Programming	N.S.N. College of Engineering	27-01-2014 to 31-01-2014 (5)

6	Introduction to J2EE Programming	Narasu's Sarathy Institute of Technology	23-07-2015 to 24-07-2015 (2)
7	Database Design and Programming with SQL	P.S.G. College of Technology	21-03-2016 to 25-03-2016 (5)
8	Foundation Program 5.0	Infosys Limited, Chennai	26-12-2016 to 30-12-2016 (5)
9	Explore Machine Learning using R	Infosys Limited, Bangalore	15-03-2017 to 17-03-2017 (3)
10	UI Technologies	K.S.R. College of Engineering	29-03-2017 to 31-03-2017 (3)
11	Foundation Program 4.1	Sethu Institute of Technology	06-11-2017 to 10-11-2017 (5)
12	Impact of Green Computing for Minimizing e-waste on Human Health	K.S.R. College of Engineering	03-07-2018 to 04-07-2018 (2)
13	INFYTQ Based FP	Erode Sengunthar Engineering College	27-06-2019 to 29-06-2019 (3)
14	Advanced Technology Program	WIPRO Limited, Bangalore	05-02-2020 to 07-02-2020 (3)
15	Artificial Intelligence and Machine Learning	Learning Loft Foundation, Madurai	19-02-2020 to 20-02-202 (2)
16	One Day Workshop on C and C++	K.S.Rangasamy College of Technology	29-02-2020 (1)

09. Area of Interest : WEB APPLICATION

10. Professional Membership : ISTE

11. Details of the Subjects Handled (in KSRCE)

S. No	Academic Year	Semesters	Name of the Subject	Year & Class of students	% of Pass
1.	2010-2011	ODD	FUNDAMENTALS OF COMPUTING	I MECH B & AUTO	90 & 88
2.	2010-2011	EVEN	ADVANCED JAVA PROGRAMMING	III IT	89
3.	2011-2012	ODD	FUNDAMENTALS OF COMPUTING	I CIVIL B & C	85 & 83
4.	2011-2012	EVEN	ENTERPRISE COMPUTING	III IT	95
5.	2012-2013	ODD	FUNDAMENTALS OF COMPUTING	I MECH B	90
6.	2012-2013	EVEN	PROGRAMMING DATA STRUCTURES	I IT	84
7.	2013-2014	ODD	OBJECT ORIENTED PROGRAMMING	II IT	90
8.	2013-2014	EVEN	JAVA PROGRAMMING	II IT	92
9.	2014-2015	ODD	INFORMATION CODING THEORY	III IT	88
10.	2014-2015	EVEN	WEB TECHNOLOGY	I IT (PG)	100

11.	2015-2016	ODD	NETWORK DESIGN AND SECURITY MANAGEMENT	IV IT	98
12.	2015-2016	EVEN	ADVANCED COMPUTER ARCHITECTURE	I CSE (PG)	100
13.	2016-2017	ODD	PROFESSIONAL ETHICS	IV CSE B	100
14.	2016-2017	EVEN	C PROGRAMMING	I CSE A	86
15.	2017-2018	ODD	INTERNET PROGRAMMING	IV CSE B	98
16.	2017-2018	EVEN	C PROGRAMMING	I CSE B	80
17.	2018-2019	ODD	PROBLEM SOLVING TECHNIQUES	I CSE B	91
18.	2018-2019	EVEN	C PROGRAMMING	I CSE B	89
19.	2019-2020	ODD	PROBLEM SOLVING TECHNIQUES	I CSE B	92
20.	2019-2020	EVEN	C PROGRAMMING	I CSE B	96
21.	2020-2021	ODD	PROBLEM SOLVING TECHNIQUES	I CSE A	95
22.	2020-2021	EVEN	C PROGRAMMING	I CSE A	94

12. Additional Responsibilities

a. College Level

S. No.	Details of Work	Work allotted by	Duration
1.	WIPRO PRP TRAINING	Principal	June 2016 to Till now
2.	College level Technical Trainer	Placement & Training Cell	June 2021 to Till now

b. Department Level

S. No.	Details of Work	Work allotted by	Duration
1.	Web Site Incharge	HOD	June 2011 to April 2016
2.	Technical Trainer	HOD	June 2016 to Till now.

13. Self-Appraisal

Major Strengths: 1.Hard work

2. Sincerity

3.Team work

Major Weaknesses: 1.Trust

2. Quick decision making 4. Like to help others.



[Signature]
PRINCIPAL
 K.S.R.COLLEGE OF ENGINEERING
 K.S.R.Kalvi Nagar, Tiruchengode-637 215
 Namakkal Dist., Tamilnadu

K.S.R. COLLEGE OF ENGINEERING (AUTONOMOUS), TIRUCHENGODE - 637 215
DEPARTMENT OF ECE
Academic Year 2021-22

Value Added Course on "Hands on Programming Language in C"
FEEDBACK FORM

Kindly provide your valuable feedback about this value added course to course to improve the quality in future.

Name of the Student : Dharani . A . C

Register No. : 73152115014

Kindly evaluate in the following scale by ticking on the relevant box.

1. Excellent 2. Good 3. Satisfactory 4. Poor

S.NO.	Description	Excellent	Good	Satisfactory	Poor
1.	Did you find the Event useful?		✓		
2.	Did it cover what you were expecting?			✓	
3.	The content was helpful.	✓			
4.	The level of the event was appropriate.	✓			
5.	The format was enjoyable			✓	
6.	Did you receive all the information?	✓			
7.	The speaker had a good understanding of the topics.	✗		✓	
8.	Whether the event worth your time?		✓		
9.	The length of the event was appropriate.	✓			
10.	Is the facilities were adequate and comfortable?		✓		



Date: 30.05.2022

PRINCIPAL

K.S.R. COLLEGE OF ENGINEERING
 K.S.R. Katvi Nagar, Tiruchengode-637 215
 Namakkal Dist., Tamilnadu

Dharani . A . C
 Signature

K.S.R. COLLEGE OF ENGINEERING (AUTONOMOUS), TIRUCHENGODE - 637 215
DEPARTMENT OF ECE

Academic Year 2021-22

Value Added Course on "Hands on Programming Language in C"

FEEDBACK FORM

Kindly provide your valuable feedback about this value added course to course to improve the quality in future.

Name of the Student : Vausha.T

Register No. : 73152115081

Kindly evaluate in the following scale by ticking on the relevant box.

1. Excellent 2. Good 3. Satisfactory 4. Poor

S.NO.	Description	Excellent	Good	Satisfactory	Poor
1.	Did you find the Event useful?		✓		
2.	Did it cover what you were expecting?	✓			
3.	The content was helpful.			✓	
4.	The level of the event was appropriate.	✓			
5.	The format was enjoyable		✓		
6.	Did you receive all the information?	✓			
7.	The speaker had a good understanding of the topics.			✓	
8.	Whether the event worth your time?	✓			
9.	The length of the event was appropriate.		✓		
10.	Is the facilities were adequate and comfortable?			✓	



Date: 30/05/22

[Signature]
PRINCIPAL

K.S.R. COLLEGE OF ENGINEERING
 K.S.R. Kalvi Nagar, Tiruchengode-637 215
 Namakkal Dist., Tamilnadu

[Signature]
 Signature

K.S.R. COLLEGE OF ENGINEERING (AUTONOMOUS), TIRUCHENGODE - 637 215
DEPARTMENT OF ECE
Academic Year 2021-22

Value Added Course on "Hands on Programming Language in C"
FEEDBACK FORM

Kindly provide your valuable feedback about this value added course to course to improve the quality in future.

Name of the Student : MANJU . M
 Register No. : 73152115049

Kindly evaluate in the following scale by ticking on the relevant box.

1. Excellent 2. Good 3. Satisfactory 4. Poor

S.NO.	Description	Excellent	Good	Satisfactory	Poor
1.	Did you find the Event useful?		✓		
2.	Did it cover what you were expecting?	✓			
3.	The content was helpful.			✓	
4.	The level of the event was appropriate.	✓			
5.	The format was enjoyable			✓	
6.	Did you receive all the information?	✓			
7.	The speaker had a good understanding of the topics.		✓		
8.	Whether the event worth your time?			✓	
9.	The length of the event was appropriate.	✓			
10.	Is the facilities were adequate and comfortable?		✓		



Date: 30.05.2022

Manju. M
 Signature

PRINCIPAL
 K.S.R. COLLEGE OF ENGINEERING
 K.S.R. Kalvi Nagar, Tiruchengode-637 215
 Namakkal Dist., Tamilnadu

KSRCE/IQAC/2021-22/P&T/IC30-64/ECE

K.S.R. COLLEGE OF ENGINEERING (AUTONOMOUS), TIRUCHENGODE - 637 215
DEPARTMENT OF ECE
Academic Year 2021-22

Value Added Course on "Hands on Programming Language in C"
FEEDBACK FORM

Kindly provide your valuable feedback about this value added course to course to improve the quality in future.

Name of the Student : BARANI.C

Register No. : 73152115007

Kindly evaluate in the following scale by ticking on the relevant box.

1. Excellent 2. Good 3. Satisfactory 4. Poor

S.NO.	Description	Excellent	Good	Satisfactory	Poor
1.	Did you find the Event useful?	✓			
2.	Did it cover what you were expecting?	✓	✓		
3.	The content was helpful.	✓			
4.	The level of the event was appropriate.	✓			
5.	The format was enjoyable		✓		
6.	Did you receive all the information?	✓			
7.	The speaker had a good understanding of the topics.			✓	
8.	Whether the event worth your time?	✓			
9.	The length of the event was appropriate.		✓		
10.	Is the facilities were adequate and comfortable?		✓		



Date: 30.05.2022

PRINCIPAL

K.S.R.COLLEGE OF ENGINEERING
K.S.R.Kalvi Nagar, Tiruchengode-637 215
Namakkal Dist., Tamilnadu

C. Band
Signature

K.S.R. COLLEGE OF ENGINEERING (AUTONOMOUS), TIRUCHENGODE - 637 215

DEPARTMENT OF ECE

Academic Year 2021-22

Value Added Course on "Hands on Programming Language in C"FEEDBACK FORM

Kindly provide your valuable feedback about this value added course to course to improve the quality in future.

Name of the Student : D. DEEPAK

Register No. : 73152115008

Kindly evaluate in the following scale by ticking on the relevant box.

1. Excellent 2. Good 3. Satisfactory 4. Poor

S.NO.	Description	Excellent	Good	Satisfactory	Poor
1.	Did you find the Event useful?	✓			
2.	Did it cover what you were expecting?		✓		
3.	The content was helpful.	✓			
4.	The level of the event was appropriate.	✓			
5.	The format was enjoyable		✓		
6.	Did you receive all the information?	✓			
7.	The speaker had a good understanding of the topics.		✓		
8.	Whether the event worth your time?	✓			
9.	The length of the event was appropriate.	✓			
10.	Is the facilities were adequate and comfortable?		✓		



Date: 30/05/2022

PRINCIPAL
K.S.R.COLLEGE OF ENGINEERING
K.S.R.Kalvi Nagar, Tiruchengode-637 215
Namakkal Dist., Tamilnadu

D. Deepak
Signature

KSRCE/IQAC/2021-22/P&T/IC30-64/ECE

K.S.R. COLLEGE OF ENGINEERING (AUTONOMOUS), TIRUCHENGODE - 637 215
DEPARTMENT OF ECE
Academic Year 2021-22

Value Added Course on "Hands on Programming Language in C"

FEEDBACK FORM

Kindly provide your valuable feedback about this value added course to course to improve the quality in future.

Name of the Student : *A. Harish*

Register No. : *73152115029*

Kindly evaluate in the following scale by ticking on the relevant box.

1. Excellent 2. Good 3. Satisfactory 4. Poor

S.NO.	Description	Excellent	Good	Satisfactory	Poor
1.	Did you find the Event useful?	✓			
2.	Did it cover what you were expecting?		✓		
3.	The content was helpful.			✓	
4.	The level of the event was appropriate.	✓			
5.	The format was enjoyable		✓		
6.	Did you receive all the information?		✓		
7.	The speaker had a good understanding of the topics.	✓			
8.	Whether the event worth your time?			✓	
9.	The length of the event was appropriate.	✓			
10.	Is the facilities were adequate and comfortable?			✓	



5.02.22

PRINCIPAL
K.S.R. COLLEGE OF ENGINEERING
K.S.R. Kalvi Nagar, Tiruchengode-637 215
Namakkal Dist., Tamilnadu

A. Harish
Signature

KSRCE/IQAC/2021-22/P&T/IC30-64/ECE

K.S.R. COLLEGE OF ENGINEERING (AUTONOMOUS), TIRUCHENGODE - 637 215
DEPARTMENT OF ECE
Academic Year 2021-22

Value Added Course on "Hands on Programming Language in C"
FEEDBACK FORM

Kindly provide your valuable feedback about this value added course to course to improve the quality in future.

Name of the Student : Dhartshini k.M

Register No. : 73152115015

Kindly evaluate in the following scale by ticking on the relevant box.

1. Excellent 2. Good 3. Satisfactory 4. Poor

S.NO.	Description	Excellent	Good	Satisfactory	Poor
1.	Did you find the Event useful?	✓			
2.	Did it cover what you were expecting?		✓		
3.	The content was helpful.			✓	
4.	The level of the event was appropriate.	✓			
5.	The format was enjoyable		✓		
6.	Did you receive all the information?			✓	
7.	The speaker had a good understanding of the topics.	✓			
8.	Whether the event worth your time?		✓		
9.	The length of the event was appropriate.			✓	
10.	Is the facilities were adequate and comfortable?	✓			



Date: 30.5.22

PRINCIPAL

K.S.R. COLLEGE OF ENGINEERING
K.S.R. Kalvi Nagar, Tiruchengode-637 215
Namakkal Dist., Tamilnadu

Dhartshini
Signature

K.S.R. COLLEGE OF ENGINEERING (AUTONOMOUS), TIRUCHENGODE - 637 215

DEPARTMENT OF ECE

Academic Year 2021-22

Value Added Course on "Hands on Programming Language in C"**FEEDBACK FORM**

Kindly provide your valuable feedback about this value added course to course to improve the quality in future.

Name of the Student : KUMARASAN . K

Register No. : T315215042

Kindly evaluate in the following scale by ticking on the relevant box.

1. Excellent 2. Good 3. Satisfactory 4. Poor

S.NO.	Description	Excellent	Good	Satisfactory	Poor
1.	Did you find the Event useful?	/			
2.	Did it cover what you were expecting?		/		
3.	The content was helpful.		/		
4.	The level of the event was appropriate.		/		
5.	The format was enjoyable			/	
6.	Did you receive all the information?			/	
7.	The speaker had a good understanding of the topics.		/		
8.	Whether the event worth your time?		/		
9.	The length of the event was appropriate.	/			
10.	Is the facilities were adequate and comfortable?				



Date: 30.5.22

PRINCIPAL

K S R. COLLEGE OF ENGINEERING
K.S.R. Kalvi Nagar, Tiruchengode-637 215
Namakkal Dist., Tamilnadu

Kumarasan
Signature

K.S.R. COLLEGE OF ENGINEERING (AUTONOMOUS), TIRUCHENGODE - 637 215

DEPARTMENT OF ECE

Academic Year 2021-22

Value Added Course on "Hands on Programming Language in C"**FEEDBACK FORM**

Kindly provide your valuable feedback about this value added course to course to improve the quality in future.

Name of the Student : *Sowmya . K*Register No. : *73152115071*

Kindly evaluate in the following scale by ticking on the relevant box.

1. Excellent 2. Good 3. Satisfactory 4. Poor

S.NO.	Description	Excellent	Good	Satisfactory	Poor
1.	Did you find the Event useful?	<input checked="" type="checkbox"/>			
2.	Did it cover what you were expecting?		<input checked="" type="checkbox"/>		
3.	The content was helpful.			<input checked="" type="checkbox"/>	
4.	The level of the event was appropriate.	<input checked="" type="checkbox"/>			
5.	The format was enjoyable			<input checked="" type="checkbox"/>	
6.	Did you receive all the information?		<input checked="" type="checkbox"/>		
7.	The speaker had a good understanding of the topics.	<input checked="" type="checkbox"/>			
8.	Whether the event worth your time?		<input checked="" type="checkbox"/>		
9.	The length of the event was appropriate.	<input checked="" type="checkbox"/>			
10.	Is the facilities were adequate and comfortable?		<input checked="" type="checkbox"/>		

Date: *30.5.2022*

[Signature]
PRINCIPAL
 K.S.R. COLLEGE OF ENGINEERING
 K.S.R. Kalvi Nagar, Tiruchengode-637 215
 Namakkal Dist., Tamilnadu

[Signature]
 K. Sowmya
 Signature

K.S.R. COLLEGE OF ENGINEERING (AUTONOMOUS), TIRUCHENGODE - 637 215

DEPARTMENT OF ECE

Academic Year 2021-22

Value Added Course on "Hands on Programming Language in C"**FEEDBACK FORM**

Kindly provide your valuable feedback about this value added course to course to improve the quality in future.

Name of the Student : Naveena . E

Register No. : 73152115054

Kindly evaluate in the following scale by ticking on the relevant box.

1. Excellent 2. Good 3. Satisfactory 4. Poor

S.NO.	Description	Excellent	Good	Satisfactory	Poor
1.	Did you find the Event useful?		✓		
2.	Did it cover what you were expecting?	✓			
3.	The content was helpful.			✓	
4.	The level of the event was appropriate.	✓			
5.	The format was enjoyable		✓		
6.	Did you receive all the information?			✓	
7.	The speaker had a good understanding of the topics.	✓			
8.	Whether the event worth your time?		✓		
9.	The length of the event was appropriate.			✓	
10.	Is the facilities were adequate and comfortable?				



Date: 05-05-2022

PRINCIPAL
K.S.R. COLLEGE OF ENGINEERING
K.S.R. Kalvi Nagar, Tiruchengode-637 215
Namakkal Dist., Tamilnadu

Naveena.
Signature

K.S.R. COLLEGE OF ENGINEERING (AUTONOMOUS), TIRUCHENGODE - 637 215
DEPARTMENT OF ECE
Academic Year 2021-22

Value Added Course on "Hands on Programming Language in C"
FEEDBACK FORM

Kindly provide your valuable feedback about this value added course to course to improve the quality in future.

Name of the Student : *Arakul S*
 Register No. : *73152115022*

Kindly evaluate in the following scale by ticking on the relevant box.

1. Excellent 2. Good 3. Satisfactory 4. Poor

S.NO.	Description	Excellent	Good	Satisfactory	Poor
1.	Did you find the Event useful?	✓			
2.	Did it cover what you were expecting?		✓		
3.	The content was helpful.			✓	
4.	The level of the event was appropriate.	✓			
5.	The format was enjoyable		✓		
6.	Did you receive all the information?	✓			
7.	The speaker had a good understanding of the topics.		✓		
8.	Whether the event worth your time?			✓	
9.	The length of the event was appropriate.	✓			
10.	Is the facilities were adequate and comfortable?		✓		



ad.

[Signature]
PRINCIPAL
 K.S.R. COLLEGE OF ENGINEERING
 K.S.R. Kalvi Nagar, Tiruchengode, 637 215
 Namakkal Dist., Tamilnadu

[Signature]
 Signature



K.S.R. COLLEGE OF ENGINEERING

(AUTONOMOUS)

TIRUCHENGODE - 637 215.

DEPARTMENT OF

ELECTRONICS AND COMMUNICATION ENGINEERING

CERTIFICATE

This is to certify that Mr./Ms. ABHIRAMI DEVI . K . R I - ECE
has successfully completed the value added course on "Hands on Programming
Language in C" from 04.04.2022 to 30.05.2022 at K.S.R. College of Engineering,
Tiruchengode.

CO-ORDINATOR

HOD - ECE



K.S.R. COLLEGE OF ENGINEERING

(AUTONOMOUS)

TIRUCHENGODE - 637 215.

DEPARTMENT OF

ELECTRONICS AND COMMUNICATION ENGINEERING

CERTIFICATE

This is to certify that Mr./Ms. KARTHIKEYAN.E I - ECE
has successfully completed the value added course on "Hands on Programming
Language in C" from 04.04.2022 to 30.05.2022 at K.S.R. College of Engineering,
Tiruchengode.

CO-ORDINATOR

HOD - ECE



K.S.R. COLLEGE OF ENGINEERING

(AUTONOMOUS)

TIRUCHENGODE - 637 215.

DEPARTMENT OF

ELECTRONICS AND COMMUNICATION ENGINEERING

CERTIFICATE

This is to certify that Mr./Ms. SWETHA.D I - ECE
has successfully completed the value added course on "Hands on Programming
Language in C" from 04.04.2022 to 30.05.2022 at K.S.R. College of Engineering,
Tiruchengode.

CO-ORDINATOR

HOD - ECE



K.S.R. COLLEGE OF ENGINEERING

(AUTONOMOUS)

TIRUCHENGODE - 637 215.

DEPARTMENT OF

ELECTRONICS AND COMMUNICATION ENGINEERING

CERTIFICATE

This is to certify that Mr./Ms. PRAVIN.D I - ECE
has successfully completed the value added course on "Hands on Programming
Language in C" from 04.04.2022 to 30.05.2022 at K.S.R. College of Engineering,
Tiruchengode.

CO-ORDINATOR

HOD - ECE

From

R.Veeramani
Associate Professor/ECE,
K.S.R. College of Engineering,
Tiruchengode-637 215.

To

The Principal,
K.S.R College of Engineering,
Tiruchengode-637 215.

Respected Sir,

Sub: Value added course on "Develop Brain e-Learning Platform – C Programming" for second year ECE students - Permission-Reg.,

Our department has planned to conduct a value added course on "Develop Brain e-Learning Platform – C Programming" for our second year students from 22.09.2021 to 21.10.2021. Kindly provide us permission to conduct the above course at our department.

Course Schedule:

Course duration: 30 Days

Approximate number of students: 45

Venue: Virtual Mode (Online)

Thanking you,

Place: Tiruchengode,
Date: 20.09.2021

Yours faithfully,

Forwarded to Principal .
R.Veeramani
20/9/21 .

(R.Veeramani)

PRINCIPAL
K.S.R. COLLEGE OF ENGINEERING
K.S.R. Kaivi Nagar, Tiruchengode-637 215
Namakkal Dist., Tamilnadu



K.S.R. COLLEGE OF ENGINEERING (Autonomous): TIRUCHENGODE - 637 215

Date: 20.09.2021

Time:11.50 a.m.

CIRCULAR

Classification	ROUTINE ✓	IMMEDIATE
ORIGINATOR:HOD- ECE		CIRCULATED TO: B.E.(ECE)II Year

Sub:VALUE ADDED COURSE 2021-22- Reg.

There will be a Value Added Course for B.E.(ECE)- II Year on topic of “**Develop Brain e-Learning Platform – C Programming**” from **22.09.2021 to 21.10.2021**, Time 06.00pm-08.00 pm on virtual mode. All the registered students are asked to attend without fail.

Note : Maximum of Register Capacity: 50 Students

Instructions to the students through Course Coordinator

1. Dress Code (Self Grooming, Formal wear with shoes)
2. Discipline and attendance is compulsory to attend the program.
3. Punctuality

If any student not follows the above he/she may not be allowed to proceed further.

HoD / ECE



PRINCIPAL
K.S.R. COLLEGE OF ENGINEERING
K.S.R. KALVI NAGAR,
TIRUCHENGODE-637,215

K.S.R. COLLEGE OF ENGINEERING (AUTONOMOUS), TIRUCHENGODE – 637 215

DEPARTMENT OF ECE

Value Added Course on “Develop Brain e-Learning Platform – C Programming” (2021-2022)

Course Contents

Date: 20.09.2021

C Programming:

1. Introduction to C Programming
2. Environment Setup
3. Program Structure
4. Basic Syntax
5. Data Types
6. Variables and Constants
7. Storage Classes
8. Operators
9. Decision Making
10. Loops
11. Functions
12. Scope Rules
13. Arrays
14. Pointers
15. Strings
16. Structures
17. Unions
18. Bit fields and typedef
19. File I/O
20. Preprocessors
21. Header files
22. Type Casting
23. Recursion
24. Memory Management



Course Coordinator



HOD / ECE



PRINCIPAL
K.S.R. COLLEGE OF ENGINEERING
K.S.R. Kalvi Nagar, Tiruchengode-637 216
Namakkal Dist., Tamilnadu

K.S.R.COLLEGE OF ENGINEERING, TIRUCHENGODE (Autonomous)**DEPARTMENT OF ECE****Value Added Courses****Develop Brain e- learning platform – C programming****List of Students Attended**

Date:20.09.2021

S.NO	Reg.No.	Students Name
1.	2015001	ANANDHA PRAKASH R
2.	2015002	BALAJI S
3.	2015003	DHANRAAJ S
4.	2015004	GIRIDHARAN P
5.	2015005	GOKUL K
6.	2015007	HARIISH R S
7.	2015008	HARISH V
8.	2015009	HEMANTH KUMAR M
9.	2015010	JAICHANDRU S
10.	2015011	JAYAPRAKASH R
11.	2015014	JEEVANANTHAM P
12.	2015018	KARTHICK RAJA P
13.	2015019	KARTHIGADEVI T
14.	2015021	KIRUTHIKA D
15.	2015020	KATHIRVEL R
16.	2015022	LOGESH S
17.	2015023	MAHAA SHURUTHY G
18.	2015025	MANOBALA S
19.	2015026	MOHANA PRASATH K
20.	2015027	MOHANKUMAR GV
21.	2015028	NAVACHITHU PONKUMAR D
22.	2015029	PANDISELVI P
23.	2015030	PERIYASAMY S
24.	2015032	PRAVEENKUMAR R
25.	2015033	PRAVEENKUMAR R
26.	2015039	SANGAVI S
27.	2015040	SANJAY L
28.	2015046	SHANJEVI M
29.	2015047	SIVAKUMAR M
30.	2015048	SNEKA GP
31.	2015049	SRI KOWSIKA V
32.	2015052	SRIVIDHYA A
33.	2015053	SUBASH M
34.	2015055	SUDHAKAR N
35.	2015062	VAISHNAVI V
36.	2015521	MUKUNDAN
37.	2015532	YASUDIN U

Course Incharge

(Mr.R.Veeramani, ASPIECE)

(Mr.JRameshkumar, AP/ICE)

**PRINCIPAL**

K.S.R.COLLEGE OF ENGINEERING
K.S.R. Kalvi Nagar, Tiruchengode-637 215
Namakkal Dist., Tamilnadu

HoD-ECE 21.09.21

KSRCE/IQAC/2021-22/P&T/IC30-64/ECE

K.S.R. COLLEGE OF ENGINEERING (AUTONOMOUS), TIRUCHENGODE – 637 215
DEPARTMENT OF ECE

**Value Added Course on “Develop Brain e-Learning Platform – C Programming”
(2021-2022)**

Course Outcomes

Date: 21.10.2021

Upon successful completion of the course, the learner will be able to :

- Realize the given problem.
- Develop algorithms for solving them.

- Express solutions to computer oriented problems using flowchart or pseudo code.
- Easily transform the designs of problem solutions into C programming language.
- Write, compile and execute C programs on a IDE.
- Apply debugging and testing techniques to find and resolve errors.
- Features of C programming over other languages can be expressed clearly.

COURSE CO-ORDINATOR

HOD-ECE 21.10.21,



PRINCIPAL
K.S.R. COLLEGE OF ENGINEERING
K.S.R. Kalvi Nagar, Tiruchengode-637 215
Namakkal Dist., Tamilnadu



C - Programming



○ Phase 1 - (Zero to Beginner) (5 hours)

In this phase you will learn the Fundamentals of the programming and you will step into programming world and gain the confident to make a code on your own.

At the end of the Phase you will be master at -

- A kick start to C programming world
- Structure and Algorithm
- Tokens in C



PRINCIPAL
K.S.R.COLLEGE OF ENGINEERING
K.S.R.Kalvi Nagar, Tiruchengode-637 215
Namakkal Dist., Tamilnadu



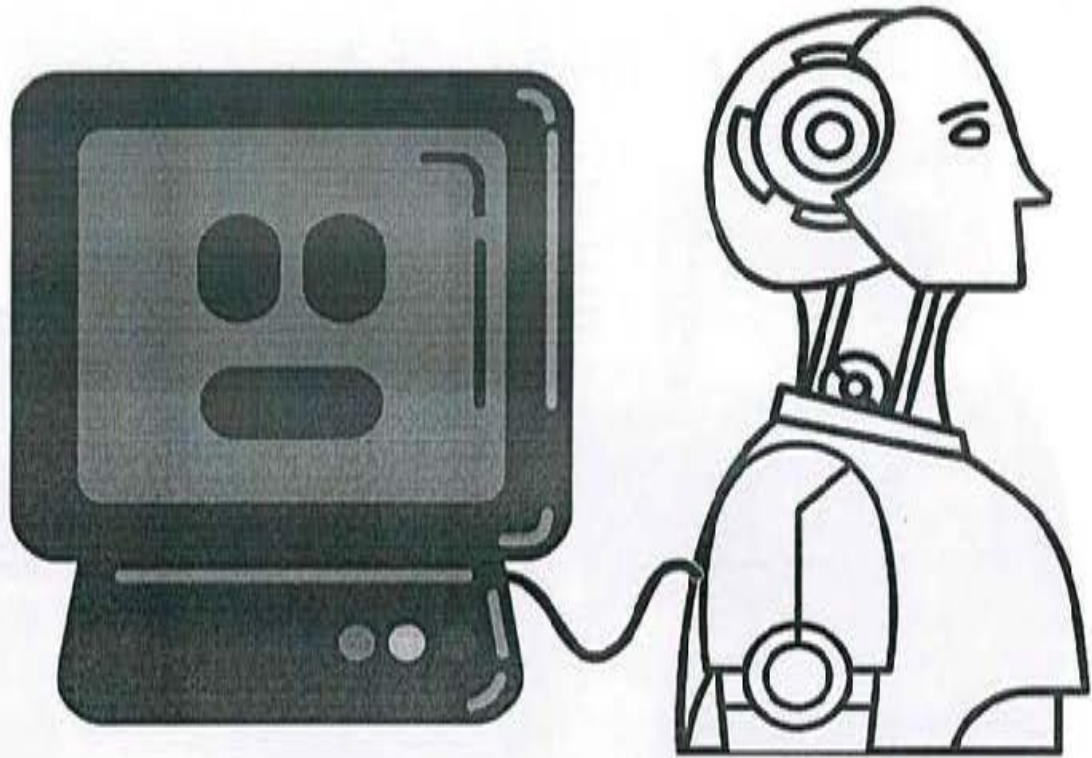

Phase 2 - (Beginner to Intermediate) (5 hours)

In this phase you will learn the most important Concept in C-programming. By understanding this concept you can able to solve problems on your own

At the end of the Phase you will be master at -

- Arrays and Strings
- Functions & Recursion
- Placement Oriented Problem solving

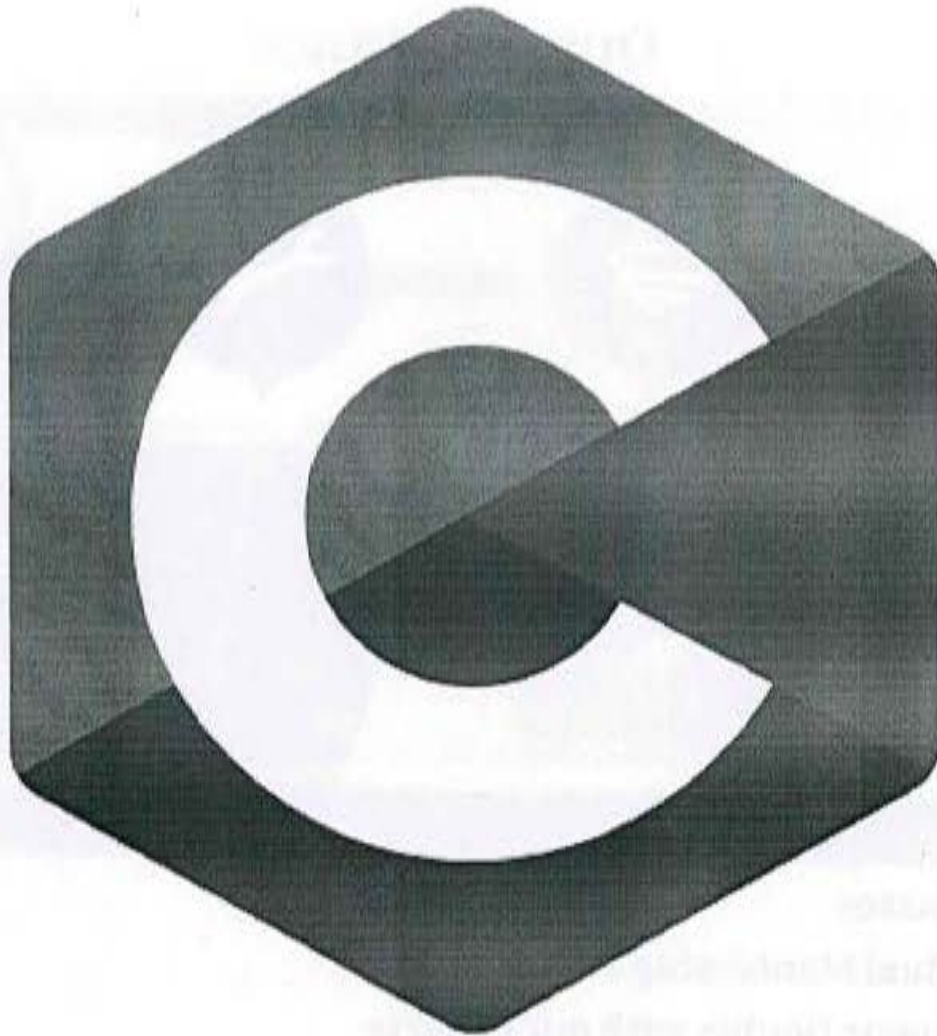

Phase 3 - (Intermediate to Advance) (5 hours)

In this phase you will learn the important concepts which will help the learners to crack online contest conducting by reputed tech giants.

At the end of the Phase you will be master at -

- Pointers
- Searching & Sorting
- Dynamic Memory allocation



Course Details

coming soon

PRINCIPAL

K.S.R.COLLEGE OF ENGINEERING
K.S.R.Kalvi Nagar, Tiruchengode-637 215
Namakkal Dist., Tamilnadu

Our Assistance

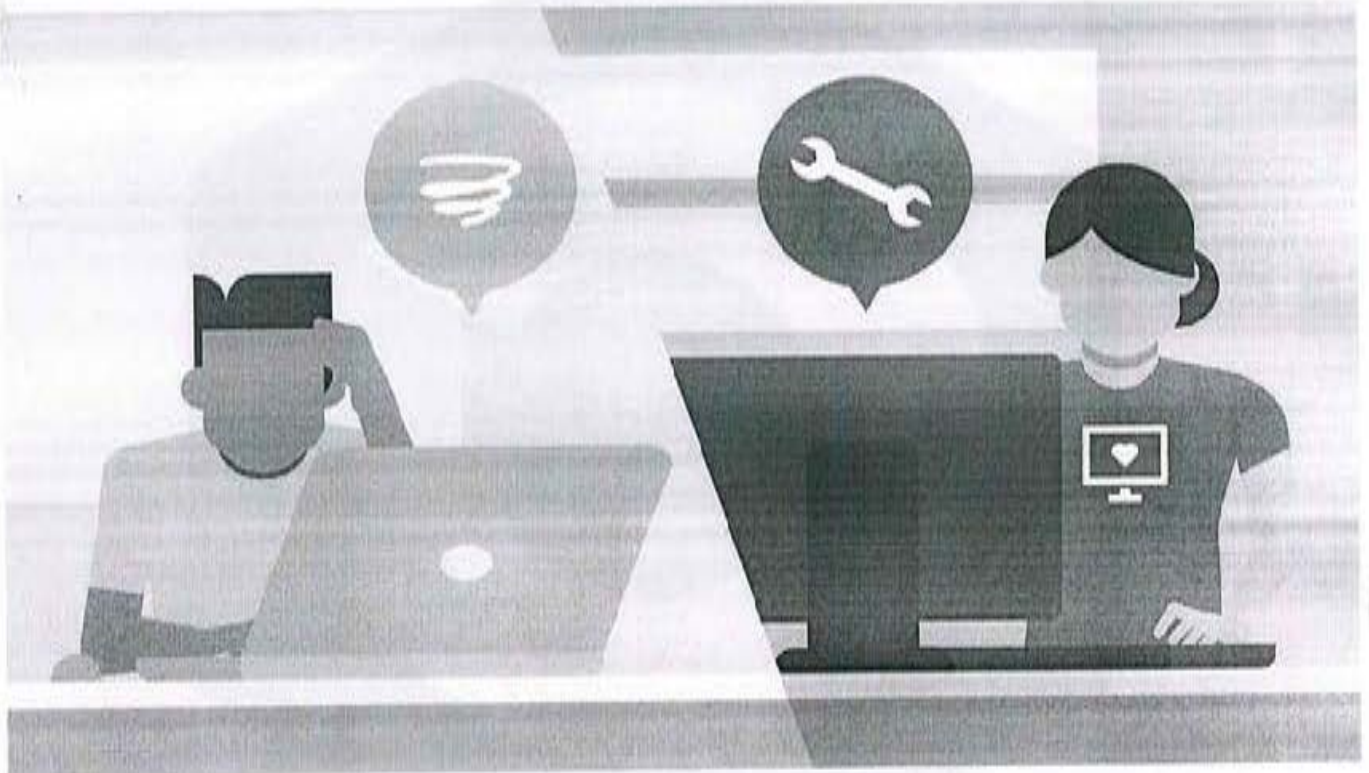

- Live Classes
- Individual Mentorship for Learners
- Dispel your Doubts with our Experts
- High quality training to novices
- Task to practice
- Assignments to improve Skills
- Certified Course

Stay connected with us



For Queries Mail us on

info@developbrain.in



developBrain

e-learning Platform



CERTIFICATE OF COMPLETION

THIS IS TO CERTIFY THAT

ANANDHA PRAKASH R

has successfully completed **C Programming** course on
DevelopBrain e-learning Platform for the duration of three weeks.

SATHIYASEELAN M

Chief Trainer
DevelopBrain



PRINCIPAL

K.S.R. COLLEGE OF ENGINEERING
K.S.R. Nagar, Tiruchengode-637 215
Namakkal Dist., Tamilnadu

Course Duration : 22th Sep. to 11th Oct. 2021

Certificate ID : 0921B3CL2039

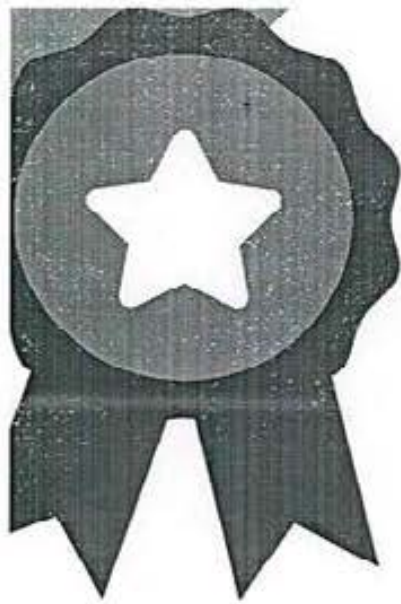

developBrain



e-learning Platform



CERTIFICATE OF COMPLETION

THIS IS TO CERTIFY THAT

Rajasri B

has successfully completed **C Programming** course on
DevelopBrain e-learning Platform for the duration of three weeks.



SATHIYASEELAN M

Chief Trainer
DevelopBrain

PRINCIPAL
K.S.R.COLLEGE OF ENGINEERING
K.S.R.Kalvi Nagar, Tiruchengode-637 215
Narthakkal Dist., Tamilnadu

Course Duration : 22th Sept - 21th Oct 2021

Certificate ID : 0921B3CL2046

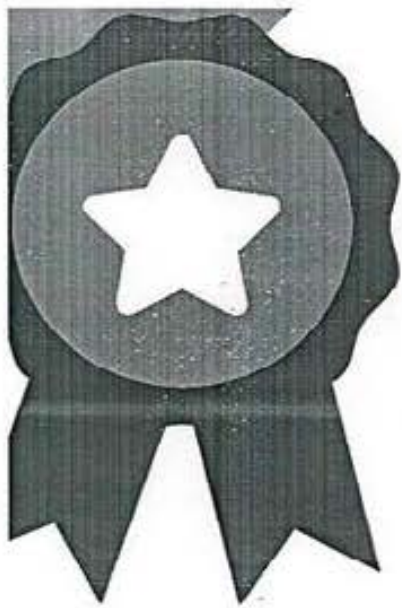

DevelopBrain



e-learning Platform

CERTIFICATE OF COMPLETION

THIS IS TO CERTIFY THAT

Sangavi S

has successfully completed **C Programming** course on
DevelopBrain e-learning Platform for the duration of three weeks.



SATHIYASEELAN M

Chief Trainer
DevelopBrain

PRINCIPAL

K.S.R.COLLEGE OF ENGINEERING
K.S.R.Kalvi Nagar, Tiruchengode-637 215
Namakkal Dist., Tamilnadu

Course Duration : 22th Sept - 21th Oct 2021

Certificate ID : 0921B3CL2050



CERTIFICATE OF COMPLETION

THIS IS TO CERTIFY THAT

KARTHIGADEVI T

has successfully completed **C Programming** course on
DevelopBrain e-learning Platform for the duration of three weeks.

SATHIYASEELAN

Chief Trainer
DevelopBrain



PRINCIPAL

Course Duration : 22th Sept, 21th Oct 2021
Certificate ID : 0921B3CL2044

K.S.R. COLLEGE OF ENGINEERING
K.S.R. Kalvi Nagar, Tiruchengode-637 215
Namakkal Dist., Tamilnadu

K.S.R. COLLEGE OF ENGINEERING (Autonomous)(An Autonomous Institution, approved by AICTE, Accredited by NAAC with A grade
& Affiliated to Anna University)**K.S.R. Kalvi Nagar, Tiruchengode - 637 215,
Namakkal District, Tamil Nadu**

Phone: 04288-274213

Fax: 04288-274757

E - mail: principal@ksrce.ac.in

Department of Mechanical Engineering

Phone :9842397730(HOD)

e - mail:hodmecht@ksrce.ac.in

Date: 05-07-2021

Submitted to Principal:**Sub.:** Permission for conducting Value Added Course on "Programming Essentials in Python"- Reg.

Respected sir,

Our department plan to conduct a Value Added Course on "Programming Essentials in Python" to the third year students of Mechanical Engineering held on 12.07.2021 to 30.08.2021, Time 09.30 am-12.30pm, at CAD LAB , D-Block First floor. Hence, we request to give me permission for the same.

Thanking You,

Resource Person / Organization Details	Coordinator Details
CISCO Netcad Python Institute Email: services@pythoninstitute.org	Mr. J.Venkatesh Assistant Professor / Mech

Copy to:

Association file & HOD file

Faculty In-Charge



Signature of HOD

Dr. A.V. BALAN M.E., Ph.D.
Professor & Head
Department of Mechanical Engineering,
KSR College of Engineering,
Tiruchengode, Tamil Nadu.

Principal

PRINCIPAL

K.S.R.COLLEGE OF ENGINEERING
K.S.R.Kalvi Nagar, Tiruchengode-637 215
Namakkal Dist., Tamilnadu

K.S.R. COLLEGE OF ENGINEERING (Autonomous): TIRUCHENGODE - 637 215

Date: 02-07-2021

Time: 10.00 a.m.

CIRCULAR

Classification	ROUTINE ✓	IMMEDIATE
ORIGINATOR:HOD - MECH		CIRCULATED TO: B.E - MECH III Year

Sub: VALUE ADDED COURSE 2021-2022 - Reg.

There will be a Valued Added Course for B.E Mechanical III Year students on topic of "Programming Essentials in Python" from 12.07.2021 to 30.08.2021, Time 09.30am-12.30pm at CAD LAB , D-Block - First Floor. All the Willing students should register their name to Course Coordinator Mr.J.Venkatesh, Assistant Professor / Mech. The resource person and other details are given below.

Resource Organization:

1. CISCO Netcad Python Institute
Email: services@pythoninstitute.org
(Online Mode)

Course Coordinator:

1. Mr. J.Venkatesh
AP / Mech

Note : Maximum of Register Capacity: 50 Students

Instructions to the students through Course Coordinator

1. Dress Code (Self Grooming, Formal wear with shoes)
2. Discipline and attendance is compulsory to attend the program.
3. Punctuality

If any student not follows the above he/she may not be allowed to proceed further.

EVIDENCE OF COMPLETION

Number of persons not received / seen: - _____

Signature of Originator with Date and time.



A.V. Balan
HOD / MECH
Dr. A.V. BALAN M.E., Ph.D.
Professor & Head
Department of Mechanical Engineering,
KSR College of Engineering,
Tiruchengode, Tamil Nadu.

[Signature]
PRINCIPAL
K.S.R.COLLEGE OF ENGINEERING
K.S.R.Kalvi Nagar, Tiruchengode-637 215
Namakkal Dist., Tamilnadu

K.S.R. COLLEGE OF ENGINEERING (Autonomous)(An Autonomous Institution, approved by AICTE, Accredited by NAAC with A grade
& Affiliated to Anna University)**K.S.R. Kalvi Nagar, Tiruchengode – 637 215,
Namakkal District, Tamil Nadu**

Phone: 04288-274213

Fax: 04288-274757

E - mail: principal@ksrce.ac.in

Department of Mechanical Engineering

Phone :9842397730 (HOD)

e - mail:uvbalan@mail.com

Date: 11-07-2021**Value added Course
On
"Programming Essentials in Python"**

S.No.	Resource Person/ Organization	Course Content
1	CISCO Netcad Python Institute Email: services@pythoninstitute.org Assistant Professor / Mech (Online Mode)	<ul style="list-style-type: none"> • Introduction to Python for mechanical Engineers • Beginning Python Basics • Python- The essentials • Variable and String methods
2	Mrs. S.Suganya, Assistant Professor, Department of Information Technology, K.S.R College of Engineering, Tiruchengode-637215.	<ul style="list-style-type: none"> • Boolean, Logic and Loops • Python Program flow • Functions and Modules • Exceptions handling

Course Outcome**Through this course students will be able to:**

- Acquire knowledge on Python Programming in Mechanical Engineering fields.
- How to use Python to solve and analyze engineering problem
- Use Python for Data Analysis
- Use of Python in Simulation Software's

By the end of this course, each student should be able to:

This Course will bring awareness of importance of python and applications of python in solving engineering problems. We will see some important libraries like SciPy, Numpy, Matplotlib, Pandas etc. used in scientific computation. This course includes Python Programs on Mechanics, Machine Design, Fluid Mechanics, Thermal Science, Heat Transfer, Vibrations, and Optimization etc. It has covered various types of plots including line plots and 2D,3D contours plots where we can use this in visualizing engineering data.

COURSE CO-ORDINATOR

Dr. A.V. BALAN M.E., Ph.D.
Professor & Head
Department of Mechanical Engineering,
KSR College of Engineering,
Tiruchengode, Tamil Nadu.

PRINCIPAL**PRINCIPAL**

K.S.R.COLLEGE OF ENGINEERING
K.S.R.Kalvi Nagar, Tiruchengode-637 215
Namakkal Dist., Tamilnadu



K.S.R. COLLEGE OF ENGINEERING

(An Autonomous Institution, Approved by AICTE, New Delhi, Affiliated to Anna University, Chennai,
Accredited by NAAC with 'A' Grade and ISO 9001:2008 Certified Institution)

R. SRINIVASAN B.B.M.,
Chairman cum Managing Trustee

Dr. P. SENTHIL KUMAR M.E., Ph.D.,(IITM)
Principal

Ref.: 01/KSRCE / MECH / VAC / 2021-2022

Date: 04-07-2021

To

Mrs.S.Suganya
Assistant Professor
Department of Information technology
KSR College of Engineering
Tiruchengode-637 215.

Sir,

Sub.: Invitation for Value Added Course – Reg.

Our department Plan to conduct a **Value Added Course** on "**Programming Essentials in Python**" to third students held on 12.07.2021 to 30.08.2021, Time 09.30am - 12.30pm. We are pleased to invite you as Resource Person for the Value Added course. The Course held at Department of Mechanical Engineering, First Floor, D-Block- CAD Lab in **K.S.R College of Engineering (Autonomous), Tiruchengode, Namakkal District, Tamilnadu, India.**

We hope you will be able to accept our invitation as a resource person for the value added course to join us in this effort. Kindly acknowledge your consent through this e-mail: hodmech@ksce.ac.in or to this number + 91 9842397730.

Best Regards



PRINCIPAL

Dr. P. Senthil Kumar, M.E., Ph.D., (IITM),
PRINCIPAL,
K. S. R. COLLEGE OF ENGINEERING,
K. S. R. KALVI NAGAR,
TIRUCHENGODE-637 215,
NAMAKKAL DI, TAMIL NADU.











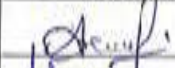
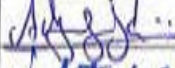

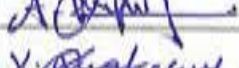
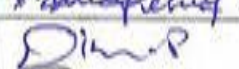

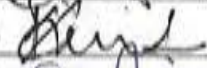
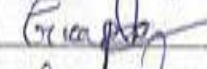
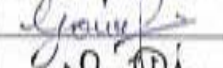
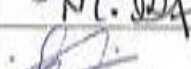
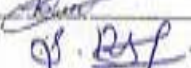

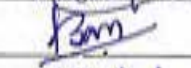
K.S.R COLLEGE OF ENGINEERING (AUTONOMOUS), TIRUCHENGODE – 637215

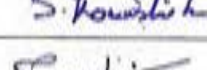
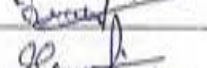
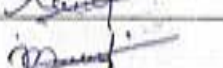
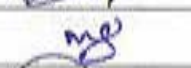
DEPARTMENT OF MECHANICAL ENGINEERING

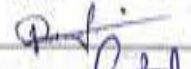
A VALUE ADDED COURSE ON "Programming Essentials in Python"

Date: 09.07.2021

STUDENT WILLINGNESS NAME LIST

S. No.	Name of the Student	Year / Branch	Signature
1.	ARAVINTHKARTHI S	III/Mech	
2.	ARJUN AJAYAGOSH	III/Mech	
3.	ASTILE ROSHAN N	III/Mech	
4.	CHANDRU A	III/Mech	
5.	CHENNAKESAVAN V	III/Mech	
6.	DINESH.P	III/Mech	
7.	ELAVARASAN A	III/Mech	
8.	GNANA SELVARAJ P	III/Mech	
9.	GOPALAKRISHNAN T	III/Mech	
10.	GOWTHAM V	III/Mech	
11.	KAVI M	III/Mech	
12.	KAVIN A	III/Mech	
13.	KAVINISH S	III/Mech	
14.	KAVINRAJ B	III/Mech	
15.	KIRAN VARGHESE	III/Mech	
16.	KISHORE J	III/Mech	
17.	KOWSHIKAN S	III/Mech	
18.	LOGANATHAN D	III/Mech	
19.	MAHESHKUMAR M	III/Mech	
20.	MATHANKANNAN M	III/Mech	
21.	MATHESH M	III/Mech	
22.	PRIYADHARSAN R	III/Mech	
23.	PUVI ARASU S	III/Mech	
24.	SATHISH C	III/Mech	
25.	SIVA PERUMAL G	III/Mech	



26.	SRINIVASAN R	III/Mech	<i>R. Srinivasan</i>
27.	SUBASH PRABHU M	III/Mech	<i>S. Subash</i>
28.	SUDHARSAN C	III/Mech	<i>C. Sudharsan</i>
29.	SUNDARESAN S	III/Mech	<i>S. Sundaresan</i>
30.	THINAKARAN S	III/Mech	<i>S. Thinakaran</i>
31.	ARUNKUMAR M	III/Mech	<i>M. Arunkumar</i>
32.	DHARUNPRASATH V	III/Mech	<i>V. Dharonprasath</i>
33.	GEORGE JEJO S	III/Mech	<i>S. George Jejo</i>
34.	GOKUL R	III/Mech	<i>R. Gokul</i>
35.	GOKULRAJ A	III/Mech	<i>A. Gokulraj</i>
36.	JAGADESH J	III/Mech	<i>J. Jagadesh</i>
37.	KISHOR G	III/Mech	<i>G. Kishor</i>
38.	LOGESHWARAN M	III/Mech	<i>M. Logeshwaran</i>
39.	MANOJ G	III/Mech	<i>G. Manoj</i>
40.	MOHANRAJA R	III/Mech	<i>R. Mohanraja</i>
41.	NAVEEN KUMAR P	III/Mech	<i>P. Naveen Kumar</i>
42.	RANJITH KUMAR B	III/Mech	<i>B. Ranjith Kumar</i>
43.	SAKTHIVEL K	III/Mech	<i>K. Sakthivel</i>
44.	SAKTHIVELAN N	III/Mech	<i>N. Sakthivelan</i>
45.	SANJAY RAJU M	III/Mech	<i>M. Sanjay Raju</i>
46.	SANTHOSH M	III/Mech	<i>M. Santhosh</i>
47.	SATHEESHKUMAR S	III/Mech	<i>S. Satheesh Kumar</i>
48.	TAMILINIYAN R	III/Mech	<i>R. Tamiliniyan</i>
49.	VIGNESH M	III/Mech	<i>M. Vignesh</i>
50.	VIGNESHWARAN V	III/Mech	<i>V. Vigneshwaran</i>
51.	KAMESH S	III/Mech	<i>S. Kamesh</i>
52.	M.VIGNESH	III/Mech	<i>M. Vignesh</i>

S. Vignesh
COURSE CO-ORDINATOR

A. V. Balan
HOD - MECH

Dr. A.V. BALAN M.E., Ph.D.
Professor & Head
Department of Mechanical Engineering,
K.S.R. College of Engineering,
Tiruchengode, Tamil Nadu

PRINCIPAL

K.S.R. COLLEGE OF ENGINEERING
K.S.R. Kalvi Nagar, Tiruchengode-637 215
Namakkal Dist., Tamilnadu



31	1916502	ARUNKUMAR M	/	/	/	/	/	h	/	a	/	/
32	1916505	DHARUNPRASATH V	/	/	/	/	/	/	/	/	/	/
33	1916508	GEORGE JEJO S	/	/	/	/	/	/	/	/	/	/
34	1916509	GOKUL R	/	/	/	/	/	/	/	/	/	h
35	1916510	GOKULRAJA	/	/	/	/	/	/	/	/	/	/
36	1916511	JAGADESH J	/	/	/	/	/	/	/	/	/	/
37	1916513	KISHOR G	/	/	/	/	/	/	/	/	/	/
38	1916514	LOGESHWARAN M	/	/	/	/	/	/	/	/	/	/
39	1916516	MANOJ G	/	/	a	/	/	/	/	/	/	/
40	1916517	MOHANRAJA R	/	/	/	/	/	/	/	/	/	/
41	1916521	NAVEEN KUMAR P	/	/	/	/	/	/	/	/	/	/
42	1916523	RANJITH KUMAR B	/	/	/	/	/	/	/	/	/	/
43	1916525	SAKTHIVEL K	/	/	/	/	/	/	/	/	/	/
44	1916526	SAKTHIVELAN N	/	/	/	/	/	/	h	/	/	/
45	1916527	SANJAY RAJU M	/	/	/	/	/	/	/	/	/	/
46	1916529	SANTHOSH M	/	/	/	/	/	h	/	h	/	/
47	1916531	SATHEESHKUMAR S	/	/	/	/	/	/	/	/	/	/
48	1916532	TAMILINIYAN R	/	/	/	/	/	/	/	/	/	/
49	1916534	VIGNESH M	/	/	/	/	/	/	/	/	/	/
50	1916535	VIGNESHWARAN V	/	/	/	/	/	/	/	/	/	/
51	1916020	KAMESH S	/	/	/	/	/	h	/	/	/	/
52	1916054	M.VIGNESH	/	/	/	/	/	/	/	/	/	/
Total No Students			52	52	52	52	52	52	52	52	52	52
Percent			52	52	50	52	52	48	52	49	52	50
Absent			=	=	2	=	=	4	=	3	=	2
Co-Ordinator Signature			Boony	Boony	Boony	Boony	Boony	Boony	Boony	Boony	Boony	Boony
HoD / MECH			(AM)	(AM)	(AM)	(AM)	(AM)	(AM)	(AM)	(AM)	(AM)	(AM)



 PRINCIPAL
 K.S.R.COLLEGE OF ENGINEERING
 K.S.R.Kalvi Nagar, Tiruchengode-637 215
 Naniakkal Disi., Tamilnadu

 Dr. A.V. BALAN M.E., Ph.D.
 Professor & Head
 Department of Mechanical Engineering,
 KSR College of Engineering,
 Tiruchengode, Tamil Nadu.

31	1916502	ARUNKUMAR M	/	/	/	/	/	/	/	/	/	
32	1916505	DHARUNPRASATH V	/	/	/	/	/	/	/	/	/	
33	1916508	GEORGE JEJO S	/	/	/	/	/	/	/	/	/	
34	1916509	GOKUL R	/	/	/	/	a	/	/	/	a	
35	1916510	GOKULRAJ A	/	/	/	/	/	/	/	/	/	
36	1916511	JAGADESH J	/	/	/	/	/	/	/	/	/	
37	1916513	KISHOR G	/	/	/	/	/	/	/	/	/	
38	1916514	LOGESHWARAN M	/	/	/	/	/	/	/	/	/	
39	1916516	MANOJ G	/	/	/	/	a	/	a	/	/	
40	1916517	MOHANRAJA R	/	/	a	/	/	/	/	/	/	
41	1916521	NAVEEN KUMAR P	/	/	/	/	/	/	/	/	/	
42	1916523	RANJITH KUMAR B.	/	/	/	/	/	/	/	/	/	
43	1916525	SAKTHIVEL K	/	/	/	/	/	/	/	/	/	
44	1916526	SAKTHIVELAN N	/	/	/	/	/	/	/	/	/	
45	1916527	SANJAY RAJU M	/	/	/	/	/	/	/	/	/	
46	1916529	SANTHOSH M	/	/	/	/	/	/	/	/	/	
47	1916531	SATHEESHKUMAR S	/	/	/	/	/	/	/	/	a	
48	1916532	TAMILINIYAN R	/	/	/	/	/	/	/	/	/	
49	1916534	VIGNESH M	/	/	/	/	/	/	/	/	/	
50	1916535	VIGNESHWARAN V	/	/	/	/	/	/	/	/	/	
51	1916020	KAMESH S	/	/	/	/	a	/	/	/	/	
52	1916054	M.VIGNESH	/	/	/	/	/	/	/	/	/	
Total No Students			52	52	52	52	52	52	52	52	52	
Percent			52	52	52	52	52	43	52	49	52	52
Absent			=	=	2	=	=	4	=	2	=	2
Co-Ordinator Signature			Exo.ry	Exo.ry	Exo.ry	Exo.ry	Exo.ry	Exo.ry	Exo.ry	Exo.ry	Exo.ry	Exo.ry
HoD / MECH			(Am)	(Am)	(Am)	(Am)	(Am)	(Am)	(Am)	(Am)	(Am)	(Am)



PRINCIPAL
K.S.R.COLLEGE OF ENGINEERING
K.S.R.Kalvi Nagar, Tiruchengode-637 215
Namakkal Dist., Tamilnadu

Dr. A.V. BALAN M.E., Ph.D.
Professor & Head
Department of Mechanical Engineering,
KSR College of Engineering,
Tiruchengode, Tamil Nadu.

K.S.R COLLEGE OF ENGINEERING(Autonomous), TIRUCHENGODE – 637 215
DEPARTMENT OF MECHANICAL ENGINEERING
FEED BACK FORM

Kindly spare a few minutes and fill up the form to help us to improve our efforts in future.

Name of the Programme : *Value added course on "Programming Essentials in Python"*
12.07.2021 to 30.08.2021 D - Block / First floor, CAD lab,
KSRCE Campus.

Name of the Student : *Arakudi R*

Register No. : *1916510*

Kindly evaluate in the following scale by ticking on the relevant grade.

1. Very Good 2. Good 3. Satisfactory 4. Unsatisfactory

- | | | | | |
|--|-------------------------------------|-------------------------------------|---|---|
| 1. Did you find the Event useful? | <input checked="" type="checkbox"/> | 2 | 3 | 4 |
| 2. Did it cover what you were expecting? | <input checked="" type="checkbox"/> | 2 | 3 | 4 |
| 3. The content was helpful. | <input checked="" type="checkbox"/> | 2 | 3 | 4 |
| 4. The level of the event was appropriate. | <input checked="" type="checkbox"/> | 2 | 3 | 4 |
| 5. The format was enjoyable. | 1 | <input checked="" type="checkbox"/> | 3 | 4 |
| 6. Did you receive all the information? | <input checked="" type="checkbox"/> | 2 | 3 | 4 |
| 7. The speaker had a good understanding of the topics. | <input checked="" type="checkbox"/> | 2 | 3 | 4 |
| 8. Whether the event worth your time? | 1 | <input checked="" type="checkbox"/> | 3 | 4 |
| 9. The length of the event was appropriate. | <input checked="" type="checkbox"/> | 2 | 3 | 4 |
| 10. Is the facilities were adequate and comfortable? | 1 | <input checked="" type="checkbox"/> | 3 | 4 |

Date: *30.08.2021*



Arakudi R
Students Signature

Ar
PRINCIPAL

K.S.R.COLLEGE OF ENGINEERING
K.S.Kalvi Nagar, Tiruchengode-637.215
Namakkal Dist., Tamilnadu.

K.S.R COLLEGE OF ENGINEERING(Autonomous), TIRUCHENGODE – 637 215
DEPARTMENT OF MECHANICAL ENGINEERING
FEED BACK FORM

Kindly spare a few minutes and fill up the form to help us to improve our efforts in future.

Name of the Programme : *Value added course on "Programming Essentials in Python"*
12.07.2021 to 30.08.2021 D – Block / First floor, CAD lab,
KSRCE Campus.

Name of the Student : *Mohanna) a : R*
Register No. : *1916517*

Kindly evaluate in the following scale by ticking on the relevant grade.

1. Very Good 2. Good 3. Satisfactory 4. Unsatisfactory

- | | | | | |
|--|-------------------------------------|-------------------------------------|---|---|
| 1. Did you find the Event useful? | <input checked="" type="checkbox"/> | 2 | 3 | 4 |
| 2. Did it cover what you were expecting? | <input checked="" type="checkbox"/> | 2 | 3 | 4 |
| 3. The content was helpful. | <input checked="" type="checkbox"/> | 2 | 3 | 4 |
| 4. The level of the event was appropriate. | 1 | <input checked="" type="checkbox"/> | 3 | 4 |
| 5. The format was enjoyable. | 1 | <input checked="" type="checkbox"/> | 3 | 4 |
| 6. Did you receive all the information? | <input checked="" type="checkbox"/> | 2 | 3 | 4 |
| 7. The speaker had a good understanding of the topics. | 1 | <input checked="" type="checkbox"/> | 3 | 4 |
| 8. Whether the event worth your time? | <input checked="" type="checkbox"/> | 2 | 3 | 4 |
| 9. The length of the event was appropriate. | 1 | <input checked="" type="checkbox"/> | 3 | 4 |
| 10. Is the facilities were adequate and comfortable? | <input checked="" type="checkbox"/> | 2 | 3 | 4 |

Date: *30.08.2021*



R. [Signature]
Students Signature

[Signature]
PRINCIPAL
K.S.R. COLLEGE OF ENGINEERING
K.S.R. Kalvi Nagar, Tiruchengode-637 215
Namakkal Dist., Tamilnadu

K.S.R COLLEGE OF ENGINEERING(Autonomous), TIRUCHENGODE – 637 215
DEPARTMENT OF MECHANICAL ENGINEERING
FEED BACK FORM

Kindly spare a few minutes and fill up the form to help us to improve our efforts in future.

Name of the Programme : *Value added course on "Programming Essentials in Python"*
12.07.2021 to 30.08.2021 D – Block / First floor, CAD lab,
KSRCE Campus.

Name of the Student : *Dharmu Prasath, V*
Register No. : *1916505*

Kindly evaluate in the following scale by ticking on the relevant grade.

1. Very Good 2. Good 3. Satisfactory 4. Unsatisfactory

- | | | | | | |
|--|-------------------------------------|---|-------------------------------------|---|---|
| 1. Did you find the Event useful? | <input checked="" type="checkbox"/> | 2 | 3 | 4 | |
| 2. Did it cover what you were expecting? | <input checked="" type="checkbox"/> | 2 | 3 | 4 | |
| 3. The content was helpful. | <input checked="" type="checkbox"/> | 2 | 3 | 4 | |
| 4. The level of the event was appropriate. | <input checked="" type="checkbox"/> | 2 | 3 | 4 | |
| 5. The format was enjoyable. | <input type="checkbox"/> | 1 | <input checked="" type="checkbox"/> | 3 | 4 |
| 6. Did you receive all the information? | <input checked="" type="checkbox"/> | 2 | 3 | 4 | |
| 7. The speaker had a good understanding of the topics. | <input type="checkbox"/> | 1 | <input checked="" type="checkbox"/> | 3 | 4 |
| 8. Whether the event worth your time? | <input checked="" type="checkbox"/> | 2 | 3 | 4 | |
| 9. The length of the event was appropriate. | <input type="checkbox"/> | 1 | <input checked="" type="checkbox"/> | 3 | 4 |
| 10. Is the facilities were adequate and comfortable? | <input checked="" type="checkbox"/> | 2 | 3 | 4 | |

Date: *30.08.2021*

V. Prasath
Students Signature



[Signature]
PRINCIPAL
K.S.R. COLLEGE OF ENGINEERING
K.S.R. Kalvi Nagar, Tiruchengode-637 215
Namakkal Dist., Tamilnadu

K.S.R COLLEGE OF ENGINEERING(Autonomous), TIRUCHENGODE – 637 215
DEPARTMENT OF MECHANICAL ENGINEERING
FEED BACK FORM

Kindly spare a few minutes and fill up the form to help us to improve our efforts in future.

Name of the Programme : *Value added course on "Programming Essentials in Python"*
12.07.2021 to 30.08.2021 D – Block / First floor, CAD lab,
KSRCE Campus.

Name of the Student : *Logeshwaran.M*
Register No. : *1916514*

Kindly evaluate in the following scale by ticking on the relevant grade.

1. Very Good 2. Good 3. Satisfactory 4. Unsatisfactory

- | | | | | |
|--|-------------------------------------|-------------------------------------|--------------------------|--------------------------|
| 1. Did you find the Event useful? | <input checked="" type="checkbox"/> | <input type="checkbox"/> | <input type="checkbox"/> | <input type="checkbox"/> |
| 2. Did it cover what you were expecting? | <input checked="" type="checkbox"/> | <input type="checkbox"/> | <input type="checkbox"/> | <input type="checkbox"/> |
| 3. The content was helpful. | <input checked="" type="checkbox"/> | <input type="checkbox"/> | <input type="checkbox"/> | <input type="checkbox"/> |
| 4. The level of the event was appropriate. | <input checked="" type="checkbox"/> | <input type="checkbox"/> | <input type="checkbox"/> | <input type="checkbox"/> |
| 5. The format was enjoyable. | <input checked="" type="checkbox"/> | <input type="checkbox"/> | <input type="checkbox"/> | <input type="checkbox"/> |
| 6. Did you receive all the information? | <input type="checkbox"/> | <input checked="" type="checkbox"/> | <input type="checkbox"/> | <input type="checkbox"/> |
| 7. The speaker had a good understanding of the topics. | <input type="checkbox"/> | <input checked="" type="checkbox"/> | <input type="checkbox"/> | <input type="checkbox"/> |
| 8. Whether the event worth your time? | <input type="checkbox"/> | <input checked="" type="checkbox"/> | <input type="checkbox"/> | <input type="checkbox"/> |
| 9. The length of the event was appropriate. | <input checked="" type="checkbox"/> | <input type="checkbox"/> | <input type="checkbox"/> | <input type="checkbox"/> |
| 10. Is the facilities were adequate and comfortable? | <input checked="" type="checkbox"/> | <input type="checkbox"/> | <input type="checkbox"/> | <input type="checkbox"/> |

Date: *30.08.2021*

M. Logesh
Students Signature



[Signature]
PRINCIPAL
K.S.R. COLLEGE OF ENGINEERING
K.S.R. Kalvi Nagar, Tiruchengode-637 215
Namakkal Dist., Tamilnadu

K.S.R COLLEGE OF ENGINEERING(Autonomous), TIRUCHENGODE – 637 215
DEPARTMENT OF MECHANICAL ENGINEERING
FEED BACK FORM

Kindly spare a few minutes and fill up the form to help us to improve our efforts in future.

Name of the Programme : *Value added course on "Programming Essentials in Python"*
12.07.2021 to 30.08.2021 D – Block / First floor, CAD lab,
KSRCE Campus.

Name of the Student : *G. Kishor*

Register No. : *1916513*

Kindly evaluate in the following scale by ticking on the relevant grade.

1. Very Good 2. Good 3. Satisfactory 4. Unsatisfactory

- | | | | | | |
|--|---|-------------------------------------|---|---|---|
| 1. Did you find the Event useful? | 1 | <input checked="" type="checkbox"/> | 2 | 3 | 4 |
| 2. Did it cover what you were expecting? | 1 | <input checked="" type="checkbox"/> | 2 | 3 | 4 |
| 3. The content was helpful. | 1 | <input checked="" type="checkbox"/> | 2 | 3 | 4 |
| 4. The level of the event was appropriate. | 1 | <input checked="" type="checkbox"/> | 2 | 3 | 4 |
| 5. The format was enjoyable. | 1 | <input checked="" type="checkbox"/> | 2 | 3 | 4 |
| 6. Did you receive all the information? | 1 | <input checked="" type="checkbox"/> | 2 | 3 | 4 |
| 7. The speaker had a good understanding of the topics. | 1 | <input checked="" type="checkbox"/> | 2 | 3 | 4 |
| 8. Whether the event worth your time? | 1 | <input checked="" type="checkbox"/> | 2 | 3 | 4 |
| 9. The length of the event was appropriate. | 1 | <input checked="" type="checkbox"/> | 2 | 3 | 4 |
| 10. Is the facilities were adequate and comfortable? | 1 | <input checked="" type="checkbox"/> | 2 | 3 | 4 |

Date: *30/08/2021*



[Signature]
PRINCIPAL
K.S.R. COLLEGE OF ENGINEERING
K.S.R. Kalvi Nagar, Tiruchengode-637 215
Namakkal Dist., Tamilnadu

[Signature]
Students Signature

K.S.R COLLEGE OF ENGINEERING(Autonomous), TIRUCHENGODE – 637 215
DEPARTMENT OF MECHANICAL ENGINEERING
FEED BACK FORM

Kindly spare a few minutes and fill up the form to help us to improve our efforts in future.

Name of the Programme : *Value added course on "Programming Essentials in Python"*
12.07.2021 to 30.08.2021 D – Block / First floor, CAD lab,
KSRCE Campus.

Name of the Student : **S AKTHIVEL K**
Register No. : **1916525**

Kindly evaluate in the following scale by ticking on the relevant grade.

1. Very Good 2. Good 3. Satisfactory 4. Unsatisfactory

- | | | | | |
|--|---|---|---|---|
| 1. Did you find the Event useful? | 1 | 2 | 3 | 4 |
| 2. Did it cover what you were expecting? | 1 | 2 | 3 | 4 |
| 3. The content was helpful. | 1 | 2 | 3 | 4 |
| 4. The level of the event was appropriate. | 1 | 2 | 3 | 4 |
| 5. The format was enjoyable. | 1 | 2 | 3 | 4 |
| 6. Did you receive all the information? | 1 | 2 | 3 | 4 |
| 7. The speaker had a good understanding of the topics. | 1 | 2 | 3 | 4 |
| 8. Whether the event worth your time? | 1 | 2 | 3 | 4 |
| 9. The length of the event was appropriate. | 1 | 2 | 3 | 4 |
| 10. Is the facilities were adequate and comfortable? | 1 | 2 | 3 | 4 |

Date: **30.08.2021**

Students Signature



PRINCIPAL
K.S.R. COLLEGE OF ENGINEERING
K.S.R. Kaivi Nagar, Tiruchengode-637 215
Namakkal Dist., Tamilnadu

Certificate of Proficiency

C. No: S21-1628

Date: 12 Oct 2021

This is to certify that

S PUVIARASU

of KSR College of Engineering, Namakkal bearing ID S158918

has successfully completed all the requirements for

Programming Essentials in Python

through assessment administered by ICT Academy and

has been awarded **C Grade**.

 Networking
CISCO Academy

A >= 80 | B >= 60 & < 80 | C >= 40 & < 60 | D < 40

Dr. B. Arivudambal
Principal, KSR College

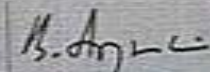

PRINCIPAL

K. S. R. COLLEGE OF ENGINEERING
K. S. R. Kalvi Nagar, Tiruchengode-637 215
Namakkal Dist., Tamilnadu



Certificate of Proficiency

C. No: S21-16292

Date: 12 Oct 2021

This is to certify that

PRIYADHARSAN

of KSR College of Engineering, Namakkal bearing ID S1589192

has successfully completed all the requirements for

Programming Essentials in Python

through assessment administered by ICT Academy and

has been awarded D Grade.

 Networking
CISCO Academy

Dr B Anubhamb
President, ICT Academy

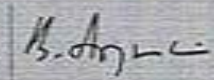

A > 80 | B >= 65 < 80 | C >= 50 < 65 | D < 50



PRINCIPAL
K.S.R. COLLEGE OF ENGINEERING
S.R. Kalai Nagar, Tiruchengode-637 215
Namakkal Dist., Tamilnadu

Certificate of Proficiency

C. No: SZ1-16295
Date: 12 Oct 2021

This is to certify that

KISHORE J

of KSR College of Engineering, Namakkal bearing ID S1589195

has successfully completed all the requirements for

Programming Essentials in Python

through assessment administered by ICT Academy and

has been awarded **D Grade**.

 Networking
CISCO Academy

A >=80 | B >=60 & <80 | C >=40 & <60 | D <40



Dr. B. Anbuthambi
Principal, ICT Academy

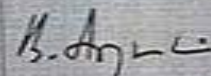

PRINCIPAL
K.S.R. COLLEGE OF ENGINEERING
S.R. Kalvi Nagar, Tiruchengode-637 215
Namakkal Dist., Tamil Nadu

Certificate of Proficiency

C. No: S21-16294

Date: 12 Oct 2021

This is to certify that

B KAVINRAJ

of KSR College of Engineering, Namakkal bearing ID S1589194

has successfully completed all the requirements for

Programming Essentials in Python

through assessment administered by ICT Academy and

has been awarded **D Grade**.

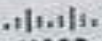
 Networking
CISCO Academy

A >= 80 | B >= 60 & < 80 | C >= 40 & < 60



B. Ananthan
President, ICT Academy

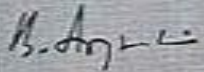

PRINCIPAL

K.S.R. COLLEGE OF ENGINEERING
K.S.R. Kalvi Nagar, Tiruchengode-637 215
Namakkal Dist., Tamil Nadu

Certificate of Proficiency

C. No: S21-16298

Date: 12 Oct 2021

This is to certify that

KAVI

of KSR College of Engineering, Namakkal bearing ID S1589198

has successfully completed all the requirements for

Programming Essentials in Python

through assessment administered by ICT Academy and

has been awarded C Grade.

Networking
CISCO Academy

A >=90 | B >=60 & <=80 | C >=40 & <=60 | D <=30

Dr. B. Anbuthambi
President, ICT Academy

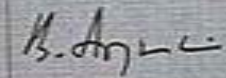

PRINCIPAL

K.S.R. COLLEGE OF ENGINEERING
K.S.R. Kavi Nagar, Tiruchengode-637 215
Namakkal Dist., Tamilnadu



KSRCE/QM/7.5.1/SFE/D 18

K.S.R. COLLEGE OF ENGINEERING, TIRUCHENGODE

DEPARTMENT OF SAFETY AND FIRE ENGINEERING

B.E. - SAFETY AND FIRE ENGINEERING

DATE: 02.03.2022

Submitted to the Principal,

Respected Sir,

Sub.: Permission to conduct a Course on "Fire and Safety Training" for First Year and Second Year B.E. - Safety and Fire Engineering Students - reg

Every Year 4th March is celebrated as Safety day and first week of March as Safety Week throughout the Country. On this behalf it is planned to conduct a Course on "Fire and Safety Training" for the benefit of the Students. So, please grant permission to take course for the students as said above from 4th March 2022 during evening hours from 04.30 to 06.30 pm. The duration of the course is 15 days only (30 hours) to create awareness on safety among the students and also we don't require any amount for the lecture and hence it is conducted by our Internal Faculties and also kindly arrange to provide tea and snacks to the students at our Varthi Hostel.

Thanking You,

Staff - In charge

L.O.D. K.P.P.

PRINCIPAL



PRINCIPAL
K.S.R. COLLEGE OF ENGINEERING
K.S.R. KALVI NAGAR,
TIRUCHENGODE-637 215

K.S.R. COLLEGE OF ENGINEERING
(AUTONOMOUS)
DEPARTMENT OF SAFETY AND FIRE ENGINEERING
COURSE ON FIRE AND SAFETY TRAINING
AGENDA

INAUGURAL FUNCTION (04.03.2022) & DAY - 1	
INAUGURAL FUNCTION	04.30 PM to 05.15 PM
BREAK	05.15 PM to 05.30 PM
INTRODUCTION ABOUT THE COURSE	05.30 PM to 06.30 PM
05.03.2022 & DAY - 2	
TYPES OF FIRES	04.30PM to 05.30PM
TYPES OF FIRE EXTINGUISHERS	05.40 PM to 06.30 PM
07.03.2022 & DAY- 3	
FIRE EXTINGUISHER COMPONENTS	04.30PM to 05.30PM
FIRE EXTINGUISHER OPERATION	05.40 PM to 06.30 PM
08.03.2022 & DAY- 4	
FIRE EXTINGUISHER MAINTENANCE	04.30PM to 05.30PM
FIRE PREVENTION	05.40 PM to 06.30 PM
09.03.2022 & DAY- 5	
FIRE SPREAD	04.30PM TO 05.30PM
WHAT TO DO IN THE EVENT OF A FIRE	05.40 PM TO 06.30 PM
10.03.2022 & DAY- 6	
FIRE SAFETY CHECKS	04.30PM TO 05.30PM
FIRE RISK ASSESSMENTS	05.40 PM TO 06.30 PM
11.03.2022 & DAY- 7	
INTRODUCTION TO FIRE HYDRANTS	04.30PM to 05.30PM
FIRE HYDRANT CLASSIFICATION	05.40 PM to 06.30 PM



AGENDA

14.03.2022 & DAY - 8	
FIRE HOSE	04.30PM to 05.30PM
FIRE HOSE REEL AND ITS USAGE	05.40 PM to 06.30 PM
15.03.2022 & DAY - 9	
SPRINKLER	04.30PM to 05.30PM
TYPES OF SPRINKLER	05.40 PM to 06.30 PM
16.03.2022 & DAY- 10	
FIRE TRUCK	04.30PM to 05.30PM
FIRE TRUCK AND USAGE	05.40 PM to 06.30 PM
21.03.2022 & DAY- 11	
ON SITE EMERGENCY PLAN	04.30PM to 05.30PM
OFF SITE EMERGENCY PLAN	05.40 PM to 06.30 PM
22.03.2022 & DAY- 12	
IN CASE OF EMERGENCY	04.30PM TO 05.30PM
FIRE ASSEMBLY POINT	05.40 PM TO 06.30 PM
23.03.2022 & DAY- 13	
TRAINING ON FIRE FIGHTING USING EXTINGUISHER	04.30PM TO 05.30PM
	05.40 PM TO 06.30 PM
24.03.2022 & DAY- 14	
FIRE SERVICE	04.30PM to 05.30PM
ROLE OF FIRE SERVICE	05.40 PM to 06.30 PM
25.03.2022 & DAY- 15	
FIRE ACCIDENT VIDEOS DEMO	04.30PM to 05.30PM
VALEDICTORY FUNCTION	05.40 PM to 06.30 PM

**K.S.R. COLLEGE OF ENGINEERING(AUTONOMOUS)
DEPARTMENT OF SAFETY AND FIRE ENGINEERING**

A Course on "Fire AND Safety Training"

DATE: 25/3/22

FEEDBACK FORM

NAME OF THE PARTICIPANT	:	Uvanesh P.S
NAME OF THE INSTITUTION	:	K.S.R. College of Engg.
MOBILE NUMBER	:	93450 75410
E-Mail ID	:	Uvaneshksrce@gmail.com

Please Strike out / Tick (✓) which is suitable to you.

1. The registration for the course was simple and efficient Yes ✓ / No / NA
2. The objectives and theme of the course were clear Yes ✓ / No / NA
3. Did the Course fulfil your reason for attending? Yes ✓ / No / NA
4. The Symposium session times were appropriate Yes / No ✓ / NA
5. The venue for the Course was appropriate Yes ✓ / No / NA
6. The quality of the tea and snacks provided was satisfactory Yes ✓ / No / NA
7. I learned something new/useful during the Course Yes ✓ / No / NA
8. I would recommend that my peers attend future Course Yes ✓ / No / NA
9. Overall, the Course met with my expectations and my attendance was worthwhile Yes ✓ / No / NA
10. What did you like most about the Course?
—
11. What did you like least about the Course?
—

GENERAL FEEDBACK REGARDING "FIRE AND SAFETY TRAINING"

 PRINCIPAL
 K.S.R. COLLEGE OF ENGINEERING
 K.S.R. KALVI NAGAR,
 TIRUCHENGODE-637 215



P.S. Uvanesh
Signature of the Participant

**K.S.R. COLLEGE OF ENGINEERING(AUTONOMOUS)
DEPARTMENT OF SAFETY AND FIRE ENGINEERING**

A Course on "Fire AND Safety Training"

DATE: 25.03.2022

FEEDBACK FORM

NAME OF THE PARTICIPANT	:	MADHANKUMAR S
NAME OF THE INSTITUTION	:	K.S.R. COLLEGE OF ENGG.
MOBILE NUMBER	:	75029 22460
E-Mail ID	:	madhan1998@gmail.com

Please Strike out / Tick (✓) which is suitable to you.

- | | | |
|----|---|--------------------|
| 1. | The registration for the course was simple and efficient | ✓
Yes / No / NA |
| 2. | The objectives and theme of the course were clear | ✓
Yes / No / NA |
| 3. | Did the Course fulfil your reason for attending? | ✓
Yes / No / NA |
| 4. | The Symposium session times were appropriate | ✓
Yes / No / NA |
| 5. | The venue for the Course was appropriate | ✓
Yes / No / NA |
| 6. | The quality of the tea and snacks provided was satisfactory | ✓
Yes / No / NA |
| 7. | I learned something new/useful during the Course | ✓
Yes / No / NA |
| 8. | I would recommend that my peers attend future Course | ✓
Yes / No / NA |
| 9. | Overall, the Course met with my expectations and my attendance was worthwhile | ✓
Yes / No / NA |

10. What did you like most about the Course?

Practical session was found very good.

11. What did you like least about the Course?

Nil.

GENERAL FEEDBACK REGARDING "FIRE AND SAFETY TRAINING"



PRINCIPAL
K.S.R. COLLEGE OF ENGINEERING
K.S.R. KALVI NAGAR,
TIRUCHENGODE-637 215

Madhan Kumar
Signature of the Participant

**K.S.R. COLLEGE OF ENGINEERING(AUTONOMOUS)
DEPARTMENT OF SAFETY AND FIRE ENGINEERING**

A Course on "Fire AND Safety Training"

DATE: 25/03/22

FEEDBACK FORM

NAME OF THE PARTICIPANT	:	M. Sakthivel
NAME OF THE INSTITUTION	:	KSRCE
MOBILE NUMBER	:	8838155832
E-Mail ID	:	Sakthivelms03@gmail.com

Please Strike out / Tick (✓) which is suitable to you.

1. The registration for the course was simple and efficient Yes / No / NA
2. The objectives and theme of the course were clear Yes / No / NA
3. Did the Course fulfil your reason for attending? Yes / No / NA
4. The Symposium session times were appropriate Yes / No / NA
5. The venue for the Course was appropriate Yes / No / NA
6. The quality of the tea and snacks provided was satisfactory Yes / No / NA
7. I learned something new/useful during the Course Yes / No / NA
8. I would recommend that my peers attend future Course Yes / No / NA
9. Overall, the Course met with my expectations and my attendance was worthwhile Yes / No / NA
10. What did you like most about the Course?
—
11. What did you like least about the Course?
—

GENERAL FEEDBACK REGARDING "FIRE AND SAFETY TRAINING"

 PRINCIPAL
 K.S.R. COLLEGE OF ENGINEERING
 K.S.R. KALVI NAGAR,
 TIRUCHENGODE-637 215



 Signature of the Participant

**K.S.R. COLLEGE OF ENGINEERING(AUTONOMOUS)
DEPARTMENT OF SAFETY AND FIRE ENGINEERING**

A Course on "Fire AND Safety Training"

DATE: 25/03/2022

FEEDBACK FORM

NAME OF THE PARTICIPANT	:	Laxmana Eswaran - S
NAME OF THE INSTITUTION	:	KSRCE
MOBILE NUMBER	:	8870404219
E-Mail ID	:	laxmana.eswaran@gmail.com

Please Strike out / Tick (✓) which is suitable to you.

1. The registration for the course was simple and efficient Yes / No / NA
2. The objectives and theme of the course were clear Yes / No / NA
3. Did the Course fulfil your reason for attending? Yes / No / NA
4. The Symposium session times were appropriate Yes / No / NA
5. The venue for the Course was appropriate Yes / No / NA
6. The quality of the tea and snacks provided was satisfactory Yes / No / NA
7. I learned something new/useful during the Course Yes / No / NA
8. I would recommend that my peers attend future Course Yes / No / NA
9. Overall, the Course met with my expectations and my attendance was worthwhile Yes / No / NA

10. What did you like most about the Course?

NIL

11. What did you like least about the Course?

NIL

GENERAL FEEDBACK REGARDING "FIRE AND SAFETY TRAINING"

 PRINCIPAL
 K.S.R. COLLEGE OF ENGINEERING
 K.S.R. KALVI NAGAR,
 TIRUCHENGODE-637 215



S. Laxmana Eswaran
 Signature of the Participant

K.S.R. COLLEGE OF ENGINEERING, TIRUCHENGODE - 617 215
DEPARTMENT OF SAFETY AND FIRE ENGINEERING
FIRE AND SAFETY TRAINING

ATTENDANCE

04/03/2022

S.No.	REG NO	NAME OF THE STUDENT	4-Mar	5-Mar	7-Mar	8-Mar	9-Mar	10-Mar	11-Mar	14-Mar	15-Mar	16-Mar	17-Mar	22-Mar	23-Mar	24-Mar	25-Mar
FIRST YEAR																	
1	73152117001	SHARATH K	/	/	/	/	/	/	/	/	/	/	/	/	/	/	/
2	73152117003	HARIHARAN M	/	/	/	/	/	/	/	/	/	/	/	/	/	/	/
3	73152117004	SAKMAPA ESWARAN S	/	/	/	/	/	/	/	/	/	/	/	/	A	/	/
4	73152117007	SAGUL PRAKASH D	/	/	/	/	/	/	/	/	/	A	/	/	/	/	/
5	73152117009	SRIKANTHRAJAM	/	/	/	/	/	/	/	/	/	/	/	/	/	/	/
6	73152117010	SUNDAR V	/	/	/	A	/	/	/	/	/	/	/	/	/	/	/
7	73152117011	EVANESH P S	/	/	/	/	/	/	/	/	/	/	/	/	/	/	/
8	73152117012	VASANATHAKUMAR V	/	/	/	/	/	/	/	/	/	/	/	/	/	/	/
9	73152117013	VEERAMANI N	/	/	/	/	/	/	/	/	/	/	/	/	/	/	/
SECOND YEAR																	
10	2017003	GUNASIKARAN S	/	/	/	/	/	/	/	/	/	A	/	/	/	/	/
11	2017006	PREMKUMAR B	/	/	/	/	/	/	/	/	/	/	/	/	/	/	/
12	2017007	SAKTHIVEL M	/	/	/	/	/	/	/	/	/	/	/	/	/	/	/
13	2017008	SHREEDAR P	/	/	/	/	/	/	/	/	/	/	/	/	/	/	/
14	2017508	BEEPAK R	/	/	/	/	/	/	/	/	/	/	/	/	/	A	/
15	2017520	JOTHIKRISHNAW T	/	/	/	/	/	/	/	/	/	/	/	/	/	/	/
16	2017522	MADHANKUMAR S	/	/	/	/	/	/	/	/	/	/	/	/	/	/	/
17	2017538	SATHYAMOORTHY K	/	/	/	/	/	/	/	/	/	/	/	/	/	/	/
18	2017540	SVAKUMAR A	/	/	/	/	/	/	/	/	/	/	/	/	/	/	/

Staff Incharge



PRINCIPAL
K.S.R. COLLEGE OF ENGINEERING
K.S.R. KALYANAGAR,
TIRUCHENGODE-617 215

HOD



PRINCIPAL
K.S.R. COLLEGE OF ENGINEERING
K.S.R. KALVI NAGAR,
TIRUCHENGODE-837 215





K.S.R. COLLEGE OF ENGINEERING
K.S.R. KALVI NAGAR,
TIRUCHENGODE-637 215



**K.S.R. COLLEGE OF ENGINEERING (Autonomous)
TIRUCHENGODE, TAMILNADU - 637 215**



**DEPARTMENT OF INFORMATION TECHNOLOGY
VALUE - ADDED COURSE**

**CISCO-NETACAD PYTHON
12.07.2021 to 17.07.2021**

in association with

ICT ACADEMY

ELCOT Complex, 2-7 Developed Plots, Industrial Estate,
Perungudi, Chennai – 600 096.

**Dr. G. SINGARAVEL
PROFESSOR AND HEAD
&**

**Mr. S. GOWTHAM
ASSISTANT PROFESSOR**

**DEPARTMENT OF INFORMATION TECHNOLOGY
K. S. R. COLLEGE OF ENGINEERING
(Autonomous)
TIRUCHENGODE - 637 215
NAMAKKAL DISTRICT, TAMILNADU-INDIA.**

PRINCIPAL
K S R COLLEGE OF ENGINEERING
TIRUCHENGODE 637 209.

JULY 2021



Singaravel Gnanasambandam <singaravelg@gmail.com>

Exclusive invitation to Setting up Cisco Networking Academy center : Reg

1 message

Narayanan <narayanan@ictacademy.in>

19 April 2021 at 13:24

To: "singaravelg@gmail.com" <singaravelg@gmail.com>

Cc: "principal@ksrce.ac.in" <principal@ksrce.ac.in>, Alagiri <Alagiri@ictacademy.in>

Respected Sir,

Greetings from ICT Academy!

Thank you for your continuous support to all our initiatives. As per our today discussion, we are glad to inform you that ICT Academy in association with Cisco NetAcad brings to you the most awaited and need of the hour certification program on "Python Programming" for the benefit of the students.

The Advantage

- CISCO is the market leader as far as Python training is concerned and therefore the training would be undisputedly of international quality.
- Certification would be by both ICT Academy and direct Global Certification at a highly subsidized price tag.
- Branding to the Institution as authorized "CISCO NETACAD CENTER"
- Post training support and doubt clarification sessions.
- An exclusive Industry Expert Seminar for the students as part of the course.
- Access to various students specific CISCO Webinars, Competitions and Events.

A detailed proposal is attached herewith for your kind reference.

Kindly share the students before this weekend, will complete the entire process before this month.

Anticipating your positive response.

Warm Regards,

Lakshmananarayanan.V

Product Manager - Academic Initiatives

ICT ACADEMY | An Initiative of Government of India, State Government and Industry
 ELCOT Complex, 2-7 Developed Plots, Industrial Estate,
 Perungudi, Chennai - 600 096, Tamil Nadu, India

91 98846-33357 | www.ictacademy.in



PRINCIPAL,
 K S R COLLEGE OF ENGINEERING,
 TIRUCHENGODE 637 209.

G. S. 19/5/2021
 Dr. G. Singaravel
 Professor & Head
 Department of Information Technology
 K.S.R. College of Engineering (Autonomous)
 Tiruchengode - 637 215
 Tirumakal (Dt), Tamilnadu, India.



The information in this email is confidential. If you are not the addressee indicated in this message (or responsible for delivery of the message to such person), you may not copy or deliver this message to anyone. In such case, you should destroy this message, and notify the sender immediately. If you or your employer does not consent to e-mail messages of this kind, please advise the

sender immediately. Opinions, advice and other information expressed in this message are not given or endorsed by employer unless otherwise indicated by an authorized representative independent of this message. Opinions, advice and other information contained in this email are subject to the terms and conditions expressed in the governing ICT Academy nondisclosure agreement or software license and services agreement

3 attachments

 **Cisco Network Academy.pdf**
633K

 **Enrollment sheet.xls**
28K

 **Skilltester Form.pdf**
29K





Singaravel Gnanasambandam <singaravelg@gmail.com>

Cisco Network Academy Python Programme - Invoice : Reg

1 message

Narayanan <narayanan@ictacademy.in>

28 April 2021 at 16:15

To: "principal@ksrce.ac.in" <principal@ksrce.ac.in>

Cc: "singaravelg@gmail.com" <singaravelg@gmail.com>, Alagiri <Alagiri@ictacademy.in>

Respected Sir,

Warm Greetings !

Thank you for your support to initiate **Cisco Network Center Python Programming training** to your students. As discussed with **Dr.Singaravel,IT Hod & ICT Academy coordinator** we have given concurrence to **Cisco to initiate Python training for your 150 students**, will requesting with Cisco for NetAcad membership for your institution.

Please find the attached Skilltester Form & Invoice. Request you to complete the process before May 10th. Anticipating your positive support as always.

Warm Regards,

Lakshmananarayanan.V

Product Manager - Academic Initiatives

ICT ACADEMY | An Initiative of Government of India, State Government and Industry

ELCOT Complex, 2-7 Developed Plots, Industrial Estate,

Perungudi, Chennai - 500 096, Tamil Nadu, India

91 98846-33357 | www.ictacademy.in



The information in this email is confidential. If you are not the addressee indicated in this message (or responsible for delivery of the message to such person), you may not copy or deliver this message to anyone. In such case, you should destroy this message, and notify the sender immediately. If you or your employer does not consent to e-mail messages of this kind, please advise the sender immediately. Opinions, advice and other information expressed in this message are not given or endorsed by employer unless otherwise indicated by an authorized representative independent of this message. Opinions, advice and other information contained in this email are subject to the terms and conditions expressed in the governing ICT Academy nondisclosure agreement or software license and services agreement.

2 attachments

Cisco NetAcad Programming Essentials in Python -Invoice (1).pdf
68K

SkillTester_Order_Form.pdf
29K



G.S.
28/5/2021

Dr. G. Singaravel
Professor & Head

Department of Information Technology
K.S.R. College of Engineering (Autonomous)
Tiruchengode - 637 215
Nanakkal (Dt), Tamilnadu, India.

PRINCIPAL,
K S R COLLEGE OF ENGINEERING
TIRUCHENGODE 637 205

K.S.R. COLLEGE OF ENGINEERING, TIRUCHENGODE - 637 215
DEPARTMENT OF INFORMATION TECHNOLOGY
"VALUE ADDED COURSE ON CISCO - NETACAD PYTHON"
SUPPORTED BY ICT ACADEMY OF TAMIL NADU
DURATION: 48 HOURS (12.07.2021 to 17.07.2021)

S.No.	ROLL No.	STUDENT NAME	S.No.	ROLL No.	STUDENT NAME
1	1921001	ABIRAMI S M /	31	1921035	PRABHU G /
2	1921002	ABOORVA V /	32	1921036	PRASANTH R /
3	1921003	AKILA A /	33	1921037	PROMOTH MAHAJAN P /
4	1921004	AKSHAYAA RAAJA SHRI /	34	1921038	PUSHPARAJ D /
5	1921005	ANNA LAKSHMI S /	35	1921039	RAGUL G /
6	1921006	ARAVIND B /	36	1921040	RAHUL B /
7	1921007	BALAJI R /	37	1921041	RAJKUMAR S /
8	1921008	BHUPESH G /	38	1921042	RAMESHKRISHNAN M /
9	1921009	BLESSING ANTONY G S /	39	1921043	RANJITHKUMAR T /
10	1921010	CHITRA S /	40	1921044	SANTHOSH G /
11	1921011	DEEPAKKUMAR A /	41	1921045	SARAVANAN B /
12	1921012	DHARUN B R /	42	1921046	SASIDHARAN S /
13	1921015	DHURGADEVI S /	43	1921047	SNEKA B /
14	1921016	DINESH R /	44	1921048	SOHAIL AHMED M /
15	1921017	GOKUL RAJA S /	45	1921049	SOUNDAR M /
16	1921018	GOPALAKRISHNAN S /	46	1921050	SOWMIYA B /
17	1921019	GOWTHAM D /	47	1921051	SOWMIYA N /
18	1921020	GUNALAN N /	48	1921052	STEFFIGRAF R /
19	1921021	HARIKRISHNAN S /	49	1921055	SURYA S /
20	1921024	KAMALEE S /	50	1921056	THANIYEAL P /
21	1921025	KAMALESREE P B /	51	1921057	THAVANISH P S /
22	1921026	KAVIN KUMAR R /	52	1921058	THINAKARAN P /
23	1921027	LOGESH V /	53	1921059	VIJAY J E /
24	1921028	MYILRAJ R /	54	1921060	VISHNU B /
25	1921029	NALLASIVAMANI P /	55	1921501	SAKTHIVELA
26	1921030	NANDHINI S /			
27	1921031	NANDHINI S /			
28	1921032	NATHEEM J /			
29	1921033	NISHANTH R /			
30	1921034	PAVITHRA M /			



PRINCIPAL

K.S.R. COLLEGE OF ENGINEERING,
TIRUCHENGODE - 637 209

CO-ORDINATOR

Willing list
(55)

HoD-IT

Department of Information Technology
K.S.R. College of Engineering (Autonomous)
Tiruchengode - 637 215
www.ksrce.edu.in

PRINCIPAL



To
Dr.P.Senthilkumar,
Principal,
KSR College of Engineering,
Tiruchengode,Namakkal,
Tamil Nadu, South India.

Respected Sir,

Greetings from ICT Academy!

ICT Academy in partnership with CISCO proposes to offer industry specific student skill development programs and certifications for students. CISCO through its initiative aims to provide industry recognised credentials that can help students succeed in their career. This course on Python programming focuses on building the students ability to accomplish coding, tasks related to programming in Python language and notions and techniques used in object oriented programming.

In partnership with CISCO NetAcad, ICT Academy aims at setting up CISCO NetAcad centers across its member colleges to provide free learning resources to the students and also offer specialized career development program to students on subsidized fees to empower the Indian youth and also reduced the minimum students count to 60 per Institution (*Ruler Institutions)

Why Python?

It will give the students a solid foundation and allow the students to learn other programming languages (e.g., C++, C or Java) much easier and much faster.

Python is recommended for aspiring young developers who are interested in pursuing careers in Artificial Intelligence, Machine Learning and Data Science.

Features of the Program

- Blended Model of Teaching-Learning process which includes VILT and Self Learning. Students can access the course materials and tests through the learning dashboard. Hands-on practice activities and over 35 lab exercises to reinforce learning.
- Access to student forums where you can ask questions and interact with instructors and peers.
- Quizzes and chapter assessments, and pre-final and final tests to measure understanding.



PRINCIPAL,
K S R COLLEGE OF ENGINEERING,
TIRUCHENGODE - 637 209

An Initiative of Government of India, State Government and Industry. An ISO 9001: 2015 Certified Organisation

CT Academy, ELCOT Complex, 2-7 Developed Plots, Industrial Estate, Perungudi, Chennai - 600 096, India Phone:
+91 44 4290 6800 | Fax: +91 44 4290 6820 | www.ictacademy.in



Benefits out the program :

- Opportunity for institution to become CISCO NetAcad Institution Member
- High-quality learning sources, learning tools, education platform and teaching resources all licensed free of charges for students
- Equip the students with industry

Domain skills Dual certification for the students

- ICT Academy Certificate in Python programming
- PCAP – Programming Essentials in Python

Kindly find attached the detailed proposal for certificate course on Programming Essentials in PYTHON in association with Cisco Networking Academy and Model College-ICT Academy

For Establishment of CISCO NetAcad Centre at institution powered by ICT Academy and training of the first batch of students on Python Programming.	Minimum Students :200 Training fee per students :INR 500+18% GST
--	---

For further details please revert,

Regards,

Lakshmana Narayanan.V,
Product Manager – Academic Operations
ELCOT Complex, 2-7 Developed Plots,
Industrial Estate, Perungudi, Chennai – 600 096.
Mobile : 98846 33357 | Phone : 044-42906800 | Fax : 044-42906820
www.ictacademy.in

Dr. G. Singaravel
Professor & Head

Department of Information Technology
S.R. College of Engineering (Autonomous)
Tiruchengode - 637 215
Namakkal (Dt), Tamilnadu, India.



K.S.R. COLLEGE OF ENGINEERING, TIRUCHENGODE – 637 215
DEPARTMENT OF INFORMATION TECHNOLOGY
"VALUE ADDED COURSE ON CISCO – NETACAD PYTHON"
SUPPORTED BY ICT ACADEMY OF TAMIL NADU
DURATION: 70 HOURS (12.07.2021 to 17.07.2021)

S.No.	Reg. No.	Name	ID No. /	Certificate No.	Sign.
1	1921001	ABIRAMI S M	S1589260	S21-16-60	S.M. Ar
2	1921002	ABOORVA V	S1589125	S21	
3	1921003	AKILA A	S1589145	S21-16215	A.K.I.A
4	1921004	AKSHAYAA RAAJA SHRI I	S158914	S21-1624	I.T. Ar
5	1921005	ANNA LAKSHMI S	S1589169	S21-16269	A.L.S
6	1921006	ARAVIND B	S1589148	S21-16248	B. Ar
7	1921007	BALAJI R	S158912	S21-1622	R. Balaji
8	1921008	BHUPESH G	S1589101	S21-16201	G. Ar
9	1921009	BLESSING ANTONY G S	S1589102	S21-16202	A.G.S
10	1921010	CHITRA S	S158912	S21-1622	Chitra
11	1921011	DEEPAKKUMAR A	S158910	S21-1620	A. Ar
12	1921012	DHARUN B R	S1589254	S21-16-54	B.R. Ar
13	1921015	DHURGADEVI S	S1589119	S21-16219	S. Ar
14	1921016	DINESH R	S1589129	S21-16229	R. Ar
15	1921017	GOKUL RAJA S	S1589161	S21-1626	G.R. Ar
16	1921018	GOPALAKRISHNAN S	S15891	S21-1629	S. Ar
17	1921019	GOWTHAM D	S1589104	S21-16204	D. Ar
18	1921020	GUNALAN N	S1589144	S21-16244	N. Ar
19	1921021	HARIKRISHNAN S	S15891	S21-162	S. Ar
20	1921024	KAMALEE S	S1589126	S21-16226	S. Ar
21	1921025	KAMALESREE P B	S1589164	S21-16264	P. Ar
22	1921026	KAVIN KUMAR R	S158915	S21-162-5	R. Ar
23	1921027	LOGESH V	S1589256	S21-16-56	V. Ar
24	1921028	MYILRAJ R	S1589121	S21-16221	R. Ar
25	1921029	NALLASIVAMANI P	S1589162	S21-16262	P. Ar
26	1921030	NANDHINI S	S1589100	S21-16200	S. Ar
27	1921031	NANDHINI S	S158918	S21-162-8	S. Ar
28	1921032	NATHEEM J	S158912	S21-162-2	J. Ar
29	1921033	NISHANTH R	S1589166	S21-16266	R. Ar
30	1921034	PAVITHRA M	S158910	S21-162-0	M. Ar

S.No.	Reg. No.	Name	ID No.	Certificate No.	Sign.
31	1921035	PRABHU G	S1589124	S 21-16224	G. Prabh
32	1921036	PRASANTH R	S1589154	S21-16254	R. Prasad
33	1921037	PROMOTH MAHAJAN P	S1589151	S21-16251	P. Promoth
34	1921038	PUSHPARAJ D	S1589106	S21-16206	D. Pushparaj
35	1921039	RAGUL G	S158916	S21-162-6	R. Ragul
36	1921040	RAHUL B	S1589105	S21-16209	B. Rahul
37	1921041	RAJKUMAR S	S1589146	S21-16246	S. Rajkumar
38	1921042	RAMESHKRISHNAN M	S1589142	S21-16242	M. Ramesh
39	1921043	RANJITHKUMAR T	S1589156	S21-16256	T. Ranjithkumar
40	1921044	SANTHOSH G	S1589140	S21-16240	G. Santhosh
41	1921045	SARAVANAN B	S1589120	S21-16220	B. Saravanan
42	1921046	SASIDHARAN S	S1589128	S21-16228	S. Sasidharan
43	1921047	SNEKA B	S158910	S21-162-0	B. Sneka
44	1921048	SOHAIL AHMED M	S1589158	ABSENT	ABSENT
45	1921049	SOUNDAR M	S158919	S21-16279	M. Soundar
46	1921050	SOWMIYA B	S1589160	S21-16260	B. Sowmya
47	1921051	SOWMIYA N	S1589141	S21-16241	N. Sowmya
48	1921052	STEFFIGRAF R	S1589152	S21-16235	R. Steffigraf
49	1921053	SUMAN K S	S1589131	S21-16164	S. Suman
50	1921055	SURYA S	S1589108	S21-16208	S. Surya
51	1921056	THANIYEAL P	S158915	S21-1625	P. Thaniyeal
52	1921057	THAVANISH P S	S1589149	S21-16249	P. S. Thavanish
53	1921058	THINAKARAN P	S158914	S21-1624	P. Thinakaran
54	1921059	VIJAY J E	S158911	S21-162	J. E. Vijay
55	1921060	VISHNU B	S1589122	S21-16222	B. Vishnu
56	1921501	SAKTHIVELA A	S158915	S21-16333	A. Sakthivel

T. Chandrasekhar
Co-ordinator



PRINCIPAL,
K.S.R. COLLEGE OF ENGINEERING,
TIRUCHENGODE 637 209

Dr. G. Srinivasan
Professor & Head
Department of Information Technology
K.S.R. College of Engineering (Autonomous)
Tiruchengode - 637 215
Namakkal (Dt), Tamilnadu, India.

K.S.R.COLLEGE OF ENGINEERING: TIRUCHENGODE - 637 215
(Autonomous)

Date: 05-10-2021

Time: 10.00 a.m.

CIRCULAR

Classification	ROUTINE	√ IMMEDIATE
ORIGINATOR : PRINCIPAL		CIRCULATED TO: All HOD s, ICTACT Coordinate, 3th Year B.E./B.Tech.

Sub.: CISCO Python - PCAP Certificate Assessment – Reg.

There will be a CISCO NetAcad Python conduct PCAP Certificate assessment on 11th & 12th Oct for 168 of Third Year students of B.E/B.Tech through **Physical Mode** at IT Lab, Second Floor, ' D Block' at our campus. The details of Batch, Venue and Schedule are given,

11.10.2021 (Monday) - 10.00 Am to 03.00 Pm - 85 students (3rd Year IT, ECE, EEE dept)

12.10.2021 (Tuesday) - 10.00 Am to 03.00 Pm - 83 students (3rd Year Mech, Civil dept)

Note: Students come to the campus with Laptop if possible

Enclosed: Name list & Batch Details

G. S. Singaravel
 5/10/21
 ICTACT Coordinator
 (Dr. G. Singaravel)

Dr. G. Singaravel
 Professor & Head
 Department of Information Technology
 K.S.R. College of Engineering (Autonomous)
 Tiruchengode - 637 215
 1. Department ICTACT Coordinator
 2. All Faculty and Students



pr
 PRINCIPAL
 PRINCIPAL,
 K.S.R. COLLEGE OF ENGINEERING,
 TIRUCHENGODE 637 209.

EVIDENCE OF COMPLETION

Number of persons not received / seen: - _____

Signature of Originator with Date and time.

K.S.R.College of Engineering (Autonomous), Tiruchengode -637 215**CISCO NetAcad Python - PCAP Certificates Assessment**

11.10.2021 (Monday) - 10.00 Am to 03.00 Pm - 85 students

3th Year IT, ECE, EEE dept

S.No	Student ID	Name	Degree	Department	Current Third Year of Studying	Mail ID
1	S1589100	Nandhini S	Female	B.Tech	Information Technology	sn2262002@gmail.com
2	S1589101	Bhupesh G	Male	B.Tech	Information Technology	massthamizhan6302@gmail.com
3	S1589102	G.S Blessing Antony	Male	B.Tech	Information Technology	blessingantony17@gmail.com
4	S1589103	Deepakkumar.A	Male	B.Tech	Information Technology	deepakkumardkanbu@gmail.com
5	S1589104	Gowtham.D	Male	B.Tech	Information Technology	gowthamdhanabal64@gmail.com
6	S1589105	B.Rahul	Male	B.Tech	Information Technology	romeorahul286@gmail.com
7	S1589106	Pushparaj.D	Male	B.Tech	Information Technology	pushparajduraiv3@gmail.com
8	S1589108	surya.s	Male	B.Tech	Information Technology	rocksuryak@gmail.com
9	S1589109	HARI GOKUL S	Male	B.E	EEE	harigokul476@gmail.com
10	S1589110	Selvakumar B	Male	B.E	EEE	arun8754105587@gmail.com
11	S1589111	KABEENA.K.J	Female	B.E	EEE	kabeenakj@gmail.com
12	S1589112	Devasena G	Female	B.E	EEE	devasenag25@gmail.com
13	S1589113	Yuvasanthirika K	Female	B.E	EEE	yuvasanthirikka@gmail.com
14	S1589114	SRIDHAR.A	Male	B.E	EEE	srisridhar1622@gmail.com
15	S1589115	NALAN .R	Male	B.E	EEE	nalan.rajamannan@gmail.com
16	S1589116	Janani.S	Female	B.E	EEE	Sekar23575@gmail.com
17	S1589117	KAARTHIKEYAN S	Male	B.E	EEE	kaarthikeyansakthivel742002@gmail.com
18	S1589118	ABINAYA N	Female	B.E	EEE	Abinayanarayanan27@gmail.com
19	S1589119	Dhurgadevi S	Female	B.Tech	Information Technology	durgadevisivakumar2019@gmail.com
20	S1589120	Saravanan.B	Male	B.Tech	Information Technology	saravanansaran1514309@gmail.com
21	S1589121	MYILRaj R	Male	B.Tech	Information Technology	myilraja007@gmail.com
22	S1589122	Vishnu B	Male	B.Tech	Information Technology	vishnubalu005@gmail.com
23	S1589123	Chitra Sampath	Female	B.Tech	Information Technology	chitrasam0022@gmail.com
24	S1589124	Prabhu G	Male	B.Tech	Information Technology	prabhu22gsbp@gmail.com
25	S1589125	Aboorva vijay	Female	B.Tech	Information Technology	aboo2001vijay@gmail.com
26	S1589126	Kamalee .S	Female	B.Tech	Information Technology	kamaleesubramani2001@gmail.com
27	S1589127	Balaji R	Male	B.Tech	Information Technology	rambalaji354@gmail.com
28	S1589128	Sasidharan. S	Male	B.Tech	Information Technology	sasid3391@gmail.com
29	S1589129	R.Dinesh	Male	B.Tech	Information Technology	dineshkarthickdm@gmail.com
30	S1589130	Pavithra M	Female	B.Tech	Information Technology	manikandanpavithra2019@gmail.com
31	S1589131	Vijay J.E	Male	B.Tech	Information Technology	vijayje2001@gmail.com
32	S1589132	Natheem.J	Male	B.Tech	Information Technology	natheem267@gmail.com
33	S1589133	S.Harikrishnan	Male	B.Tech	Information Technology	harikrishnan2118@gmail.com
34	S1589134	P.Thinakaran	Male	B.Tech	Information Technology	thinakaranpalanisamy2002@gmail.com

						l.com
35	S1589135	Kavin Kumar	Male	B.Tech	Information Technology	kavinkumar0835@gmail.com
36	S1589136	Ragul. G	Male	B.Tech	Information Technology	gandhiragu310@gmail.com
37	S1589137	Gopalakrishnan.S	Male	B.Tech	Information Technology	gopalakrishnansm19@gmail.com
38	S1589138	Nandhini.S	Female	B.Tech	Information Technology	nancyrajsaravanan@gmail.com
39	S1589139	Soundar M	Male	B.Tech	Information Technology	sakthisoundarra26@gmail.com
40	S1589140	Santhosh	Male	B.Tech	Information Technology	santhoshganeshan2019@gmail.com
41	S1589141	Sowmiya.N	Female	B.Tech	Information Technology	sowmianallasivam3434@gmail.com
42	S1589142	RameshKrishnan M	Male	B.Tech	Information Technology	rameshkrishna002@gmail.com
43	S1589143	I.T. Akshayaa Raaja Shri	Female	B.Tech	Information Technology	akshayaaraajashri07@gmail.com
44	S1589144	Gunalan	Male	B.Tech	Information Technology	nagarajaninfin@gmail.com
45	S1589145	Akila.A	Female	B.Tech	Information Technology	a.akila032002@gmail.com
46	S1589146	S.Rajkumar	Male	B.Tech	Information Technology	rajcumargopi42@gmail.com
47	S1589148	Aravind B	Male	B.Tech	Information Technology	aravindjai2112001@gmail.com
48	S1589149	P.S.Thavanish	Male	B.Tech	Information Technology	thavanisht@gmail.com
49	S1589150	Mohan.R	Male	B.E	EEE	mohanramakrishnan1324@gmail.com
50	S1589151	Promoth Mahajan.P	Male	B.Tech	Information Technology	promothmahi@gmail.com
51	S1589152	R.steffi graf	Female	B.Tech	Information Technology	varunsteffi@gmail.com
52	S1589153	Sakthivel A	Male	B.Tech	Information Technology	SakthivelVVBA@gmail.com
53	S1589154	Prasanth.R	Male	B.Tech	Information Technology	Prasanthramalingam04@gmail.com
54	S1589155	A.Sathishkumar	Male	B.E	EEE	sathish143eee@gmail.com
55	S1589156	Ranjith kumar. T	Male	B.Tech	Information Technology	vptselvi007@gmail.com
56	S1589157	P.Thanlyeal	Male	B.Tech	Information Technology	kavitha17052001@gmail.com
57	S1589158	Sohail Ahmed.M	Male	B.Tech	Information Technology	sohailahmed2001m@gmail.com
58	S1589160	Sowmiya.B	Female	B.Tech	Information Technology	sowmiyabalakrishnan22@gmail.com
59	S1589161	S.Gokul raja	Male	B.Tech	Information Technology	sgokulraja002@gmail.com
60	S1589162	Nallasivamani. P	Male	B.Tech	Information Technology	akajith1222@gmail.com
61	S1589164	Kamale sree P.B	Female	B.Tech	Information Technology	kamalesree@gmail.com
62	S1589166	Nishanth R	Male	B.Tech	Information Technology	rn05062001@gmail.com
63	S1589167	INFANT JENIFER R	Female	B.E	EEE	jenizeni1420@gmail.com
64	S1589168	Jaikumar	Male	B.Tech	Information Technology	jaikumarij1410@gmail.com
65	S1589169	Anna lakshmi.S	Female	B.Tech	Information Technology	anusundar0703@gmail.com
66	S1589170	Sneka.B	Female	B.Tech	Information Technology	snekababu101@gmail.com
67	S1589172	Thanuja g.v	Female	B.E	EEE	gvthanuja.2001@gmail.com
68	S1589173	BOOPATHI K	Male	B.E	EEE	bocpathi272727@gmail.com
69	S1589174	CHANDRU.S	Male	B.E	EEE	deepakchandru9909@gmail.com
70	S1589175	SAFRIN.T	Female	B.E	EEE	safrinhoufeek200@gmail.com
71	S1589209	Sakthisree Murugesan	Male	B.E	ECE	sakthisree1603@gmail.com
72	S1589210	VINOTHINI G	Female	B.E	ECE	vvinothiniganesan@gmail.com
73	S1589211	SUBASHINI	Female	B.E	ECE	subaelango060602@gmail.com
74	S1589212	TAMILSHRI S	Female	B.E	ECE	senthitamil2002@gmail.com
75	S1589213	MONISHA D	Female	B.E	ECE	ksrcemonisha@gmail.com

76	S1589214	Naveena. M	Female	B.E	ECE	naveena934@gmail.com
77	S1589215	Sushma.S	Male	B.E	ECE	sushmaraj642@gmail.com
78	S1589216	GOWRIMANOHARI S	Female	B.E	ECE	gowrimanohari.sekar@gmail.com
79	S1589217	KARTHIKA DEVI. K	Female	B.E	ECE	karthikadevi1704@gmail.com
80	S1589226	Kishore S	Male	B.E	EEE	kishoreseliah21@gmail.com
81	S1589254	Dharun.B.R.	Male	B.Tech	Information Technology	dharunc76@gmail.com
82	S1589256	Logesh.v	Male	B.Tech	Information Technology	logeshvengatasaiam2019@gmail.com
83	S1589257	S.Dheenadhayalan	Male	B.Tech	Information Technology	dheenakisparrow@gmail.com
84	S1589260	S.M.Abirami	Female	B.Tech	Information Technology	sm.abirami880@gmail.com
85	S1589262	Suman.k.s	Male	B.Tech	Information Technology	sumansaravanan2002@gmail.com

Batch-1 - 85

G. S. P. 11/10/2021

ICTACT Coordinator

Dr. G. Singaravel

Professor & Head

Department of Information Technology

K.S.R. College of Engineering (Autonomous)

Tiruchengode - 637 215

Namakkal (Dt). Tamilnadu, India.

Principal

PRINCIPAL,
K.S.R. COLLEGE OF ENGINEERING,
TIRUCHENGODE 637 209.



CISCO NetAcad Python - PCAP Certificates Assessment

12.10.2021 (Tuesday) - 10.00 Am to 03.00 Pm - 83 students

(3th Year Mech, Civil dept)

S.No	Student ID	Name	Degree	Department	Current THIRD Year of Studying	Mail ID
1	S1589107	V.Naveen	Male	B.E	Civil	naveenvelusamy0110@gmail.com
2	S1589147	Tamiliniyan.R	Male	B.E	Mechanical	tamiliniyan3338@gmail.com
3	S1589159	GOKULRAJ A	Male	B.E	Mechanical	rajg73847@gmail.com
4	S1589163	Gokul R	Male	B.E	Mechanical	gokulravi31namakkal@gmail.com
5	S1589165	N.Sakthivelan	Male	B.E	Mechanical	sakthivelan1512@gmail.com
6	S1589171	LOGESHWARAN M	Male	B.E	Mechanical	mlogesh506@gmail.com
7	S1589176	Vignesh Mohan	Male	B.E	Mechanical	vignesh27072000@gmail.com
8	S1589177	Kiran Varghese	Male	B.E	Mechanical	kiranvarghese8@gmail.com
9	S1589178	KAVINISH. Z	Male	B.E	Mechanical	kavinishs2001@gmail.com
10	S1589179	DINESH.P	Male	B.E	Mechanical	pdinesh2102@gmail.com
11	S1589180	THINAKARAN. S	Male	B.E	Mechanical	thinakarandeeepa005@gmail.com
12	S1589181	MAHESHKUMAR M	Male	B.E	Mechanical	maheshmech3333@gmail.com
13	S1589182	VIGNESH.M	Male	B.E	Mechanical	vigneshmurugan2791@gmail.com
14	S1589183	S.Puviarasu	Male	B.E	Mechanical	puviarasusubramanian18@gmail.com
15	S1589184	Chennakesavan.V	Male	B.E	Mechanical	chennakesavan160@gmail.com
16	S1589185	Loganathan	Male	B.E	Mechanical	logu6440@gmail.com
17	S1589186	S.sundaresan	Male	B.E	Mechanical	shansundaresan11@gmail.com
18	S1589187	Astile roshan. N	Male	B.E	Mechanical	roshanastile@gmail.com
19	S1589188	Sathish.C	Male	B.E	Mechanical	sathishc08052002@gmail.com
20	S1589189	A.CHANTHRU.	Male	B.E	Mechanical	chanthru002@gmail.com
21	S1589190	Gowtham.V	Male	B.E	Mechanical	gowthamv238@gmail.com
22	S1589191	Sudharsan c	Male	B.E	Mechanical	sudharsanc2002@gmail.com
23	S1589192	Priyadharsan	Male	B.E	Mechanical	ppriyadharsan95@gmail.com
24	S1589193	GNANASELVARAJ P	Male	B.E	Mechanical	gnanaselvaraj0002@gmail.com
25	S1589194	B.KAVINRAJ	Male	B.E	Mechanical	kavinbalu2002@gmail.com

26	S1589195	KISHORE J	Male	B.E	Mechanical	kishore.vj0@gmail.com
27	S1589196	Subash prabhu.M	Male	B.E	Mechanical	subashprabhum@gmail.com
28	S1589197	Aravinth karthi s	Male	B.E	Mechanical	aravinthshivakarthis@gmail.com
29	S1589198	Kavi	Male	B.E	Mechanical	kavimechksr@gmail.com
30	S1589199	MATHANKANNAN.M	Male	B.E	Mechanical	mathankannan25@gmail.com
31	S1589200	Sakthivel.K	Male	B.E	Mechanical	sharpsakthi19@gmail.com
32	S1589201	MATHESH M	Male	B.E	Mechanical	mvsm477913@gmail.com
33	S1589202	SRINIVASAN.R	Male	B.E	Mechanical	srinivasanrp27@gmail.com
34	S1589203	ARJUN AJAYAGOSH	Male	B.E	Mechanical	arjunajayagosh777@gmail.com
35	S1589204	Gopalakrishnan.T	Male	B.E	Mechanical	gopalakrishnan582001@gmail.com
36	S1589205	Kowshihan. S	Male	B.E	Mechanical	kowshikan24@gmail.com
37	S1589206	Elavarasan .A	Male	B.E	Mechanical	elavarasanmsd2010@gmail.com
38	S1589207	GEORGE JEJO	Male	B.E	Mechanical	s.georgejejo@gmail.com
39	S1589208	NaveenKumar P	Male	B.E	Mechanical	pnaveenkumar776@gmail.com
40	S1589218	Kamesh.s	Male	B.E	Mechanical	kameshivakumar022@gmail.com
41	S1589219	Satheeshkumar. S	Male	B.E	Mechanical	sathishsathishkumar583@gmail.com
42	S1589220	Hari Ganesh	Male	B.E	Automobile Engineering	hganesh388@gmail.com
43	S1589221	SETHURAMAN M	Male	B.E	Civil	sethuraman0317@gmail.com
44	S1589222	S.Venu Aravind	Male	B.E	Civil	aravind15082001@gmail.com
45	S1589223	R.Nallenthiran	Male	B.E	Civil	nallenthiranraja44@gmail.com
46	S1589224	S.Prabhakaran	Male	B.E	Civil	skyprabha21@gmail.com
47	S1589225	SARAVANAN M	Male	B.E	Civil	saravanan26022001@gmail.com
48	S1589227	Gowtham murugan	Male	B.E	Civil	gowtham1342451@gmail.com
49	S1589228	T.MANICKAVEL	Male	B.E	Civil	manickavel01@gmail.com
50	S1589229	P. Madhankumar	Male	B.E	Civil	havocmadhan72@gmail.com
51	S1589230	K.MONISH	Male	B.E	Civil	monishpmk23@gmail.com
52	S1589231	K Dhileepan	Male	B.E	Civil	abddhileep@gmail.com
53	S1589232	Kavin Raj. T	Male	B.E	Civil	rkavin313@gmail.com
54	S1589233	S.Arulkumaran	Male	B.E	Civil	arul9445578828@gmail.com
55	S1589234	Vineeth.s	Male	B.E	Civil	vineethsiva9552@gmail.com
56	S1589235	SATHISHKUMAR.M	Male	B.E	Civil	sathishkumarmcivil2019@gmail.com

57	S1589236	T.prakash	Male	B.E	Civil	itprakash2001@gmail.com
58	S1589237	Thasmeena.A	Female	B.E	Civil	thasmeenacivil2019@gmail.com
59	S1589238	Karunakaran.R	Male	B.E	Civil	rkarunakaranr@gmail.com
60	S1589239	SOhail Maqbool bhat	Male	B.E	Civil	Sohailbhat2108@gmail.com
61	S1589240	Vigneshwaran. V	Male	B.E	Mechanical	Mechvignesh220@gmail.com
62	S1589241	M.Arunkumar	Male	B.E	Mechanical	Kumararun6107@gmail.com
63	S1589242	D.Sugumar	Male	B.E	Automobile Engineering	suguthanapa00007@gmail.com
64	S1589243	Gokul Pranesh.C	Male	B.E	Automobile Engineering	gokulpranesh7885@gmail.com
65	S1589244	Balachandar.A	Male	B.E	Automobile Engineering	balac2417@gmail.com
66	S1589245	M.SANJAY RAJU	Male	B.E	Mechanical	sanjayrajuSMART4@gmail.com
67	S1589246	M.Dharani	Male	B.E	Automobile Engineering	mdharaniauto281282@gmail.com
68	S1589247	Nitheesh.B	Male	B.E	Automobile Engineering	nitheeshnitheesh009@gmail.com
69	S1589248	Nithyashree R	Female	B.E	Automobile Engineering	227nithya@gmail.com
70	S1589249	RANJITH KUMAR.B	Male	B.E	Mechanical	ranjithnashmith@gmail.com
71	S1589250	S.Sathish	Male	B.E	Automobile Engineering	sathish638236@gmail.com
72	S1589251	R mohanraja	Male	B.E	Mechanical	1998mohanlingam@gmail.com
73	S1589252	G.Kishor	Male	B.E	Mechanical	kishormech512@gmail.com
74	S1589253	Naveen kumar R D	Male	B.E	Automobile Engineering	naveenkumar46074@gmail.com
75	S1589255	DHARUNPRASATH V	Male	B.E	Mechanical	dharunprasath171@gmail.com
76	S1589258	SANJAY KUMARAN D	Male	B.E	Civil	sanjaykumarand2002@gmail.com
77	S1589259	G. Manoj	Male	B.E	Mechanical	manojgopaal@gmail.com
78	S1589261	RANJITH KUMAR P	Male	B.E	Civil	rk5996509@gmail.com
79	S1589263	M. SANTHOSH	Male	B.E	Mechanical	santhoshmurugan298@gmail.com
80	S1589264	Jagadesh. J	Male	B.E	Mechanical	jagadeshjaga385@gmail.com
81	S1589265	Siva Perumal G	Male	B.E	Mechanical	siva2002g@gmail.com
82	S1589266	Kavin.A	Male	B.E	Mechanical	ak05112001@gmail.com
83	S1589267	Ranjith kumar	Male	B.E	Civil	jegadeesh7777@gmail.com

Batch-2 - 83

G. S. P
12/10/21
ICTACT Coordinator

Dr. G. Singaravel
Professor & Head
Department of Information Technology
K.S.R. College of Engineering (Autonomous)
Tiruchengode - 637 215
Tamilnadu, India.



Principal
PRINCIPAL,
K.S.R. COLLEGE OF ENGINEERING,
TIRUCHENGODE 637 209



Singaravel Gnanasambandam <singaravelg@gmail.com>

Training confirmation - Cisco NetAcad Programming Essentials in Python : Reg

1 message

Narayanan <narayanan@ictacademy.in>

6 July 2021 at 10:51

To: "singaravelg@gmail.com" <singaravelg@gmail.com>

Cc: "principal@ksrce.ac.in" <principal@ksrce.ac.in>, Alagiri <Alagiri@ictacademy.in>

Dear Sir,

Greetings of the day !!

Thank you for your support to initiate Cisco NetAcad Programming Essentials in Python training to your students. As discussed yesterday, we hereby confirm the VILT student training from **12 July to 17 July 2021 @ 3 hours per day from 9:30am to 12:30pm.**

And the total course duration 70 hours

Virtual Instructor led Training (Live Online Session) - 18 hours (12th July to 17th July - 09.30 Am to 12.30 Pm)

Self-paced Learning - 50 hours (18th July to 23rd July - Students will receive self-learning dashboard during the online session)

Assessment - 2 hours (29th July)

Kindly ensure the students participation in online session, self-learning completion before 23rd July. Based on the students learning progress only we can conduct assessment on 29th July.

Please revert for further clarifications.

Encl : Session Plan & Resource Person Profile

G. S. 6/7/2021

Dr. G. Singaravel
Professor & Head

Department of Information Technology
K.S.R. College of Engineering (Autonomous)
Tiruchengode - 637 215
Namakkal (Dt), Tamilnadu, India.

Warm Regards,

Lakshmananarayanan.V

Product Manager - Academic Initiatives

ICT ACADEMY | An Initiative of Government of India, State Government and Industry
ELCOT Complex, 2-7 Developed Plots, Industrial Estate,
Perungudi, Chennai - 600 096, Tamil Nadu, India

91 98846-33357 | www.ictacademy.in



PRINCIPAL,
K.S.R. COLLEGE OF ENGINEERING,
TIRUCHENGODE 637 209



The information in this email is confidential. If you are not the addressee indicated in this message (or responsible for delivery of the message to such person), you may not copy or deliver this message to anyone. In such case, you should destroy this message, and notify the sender immediately. If you or your employer does not consent to e-mail messages of this kind, please advise the sender immediately. Opinions, advice and other information expressed in this message are not given or endorsed by employer unless otherwise indicated by an authorized representative independent of this message. Opinions, advice and other information contained in this email are subject to the terms and conditions expressed in the governing ICT Academy nondisclosure agreement or software license and services agreement

2 attachments

PCAP Session Plan.pdf



24K

Resource Person Profile.pdf
61K

Training Confirmation - Cisco NetAcad Programming Essentials in Python

08/02/2022

From: [Name]

To: [Name]

Subject: Training Confirmation - Cisco NetAcad Programming Essentials in Python

08/02/2022

Dear [Name],

We are pleased to confirm your registration for the Cisco NetAcad Programming Essentials in Python training. The training will be held on [Date] at [Location].

Please find the details of the training below.

Training Details:
Date: [Date]
Time: [Time]
Location: [Location]

For more information, please contact [Contact Info].

We look forward to your participation in this training. Thank you for choosing Cisco NetAcad.

Sincerely,
[Name]

[Signature]

Received by [Name]
[Address]
[City]
[State]
[Zip]

[Handwritten Signature]





Singaravel Gnanasambandam <singaravelg@gmail.com>

Fwd: Cisco NetAcad Python Assessment request : Reg

1 message

Dr.P.Senthilkumar, Principal KSRCE, TamilNadu <principal@ksrce.ac.in>
To: Singaravel Gnanasambandam <singaravelg@gmail.com>

5 October 2021 at 17:43

----- Forwarded message -----

From: **Narayanan** <narayanan@ictacademy.in>
Date: Tue, Oct 5, 2021 at 8:55 AM
Subject: Cisco NetAcad Python Assessment request : Reg
To: singaravelg@gmail.com <singaravelg@gmail.com>
Cc: principal@ksrce.ac.in <principal@ksrce.ac.in>, Alagiri <Alagiri@ictacademy.in>

Dear Sir

As discussed, we have plan to conduct PCAP assessment on 11th & 12th Oct for 168 students. Please find the details below,

11.10.2021 - 10.00 Am to 03.00 Pm - 85 students (IT,ECE,EEE dept)

12.10.2021 - 10.00 Am to 05.00 Pm - 83 students (Mech, Civil dept)

Requirement for the assessment :

- A. 50 machines lab with internet connection
- B. The students come to the campus in person (based on their batch allocation)

Kindly do the needful.

Warm Regards,

Lakshmananarayanan.V

Product Manager - Academic Initiatives

ICT ACADEMY | An Initiative of Government of India, State Government and Industry
ELCOT Complex, 2-7 Developed Plots, Industrial Estate,
Perungudi, Chennai - 500 096, Tamil Nadu, India

91 98846-33357 | www.ictacademy.in



PRINCIPAL
S R COLLEGE OF ENGINEERING,
TIRUCHENGODE - 637 209



The information in this email is confidential. If you are not the addressee indicated in this message (or responsible for delivery of the message to such person), you may not copy or deliver this message to anyone. In such case, you should destroy this message, and notify the sender immediately. If you or your employer does not consent to e-mail messages of this kind, please advise the sender immediately. Opinions, advice and other information expressed in this message are not given or endorsed by employer unless otherwise indicated by an authorized representative independent of this message. Opinions, advice and other information contained in this email are subject to the terms and conditions expressed in the governing ICT Academy nondisclosure agreement or software license and services agreement

7/26/22, 10:45 AM

Gmail - Fwd: Cisco NetAcad Python Assessment request : Reg

**

Principal
K.S.R. College of Engineering
K.S.R. Kalvi Nagar
Tiruchengode - 637 215
Namakkal District, Tamilnadu, India
Phone:(+91) 04288 274213
Fax :(+91) 04288 274757
Website : www.ksrce.ac.in

2 attachments

 **11.10.21 - IT,ECE,EEE.xlsx**
15K

 **12.10.21 - Mech, Civil.xlsx**
14K



PROFORMA INVOICE

28.04.2021

To
The Principal,
K.S.R College of Engineering,
K.S.R. Kalvi Nagar,
Tiruchengode,
Namakkal Dist.,
Tamilnadu - 637215

P.INV. NO.	DETAILS	AMOUNT (Rs.)
0419/21-22	Towards the training in Cisco NetAcad Programming Essentials in Python for 162 students @ Rs.500/- per head CGST 9% SGST 9%	81,000 7,290 7,290
	Total	95,580

(Rupees Ninety Five thousand and Five hundred Eighty only)

Payment may please be released in favour of "ICT Academy" through
Online INDIAN BANK, Current Account A/c. No. 6824312568, DB Jain
College Branch, Chennai (IFS Code: IDIB000D052).

PAN NO : AAECI6323D
GSTIN : 33AAAAI2467E1Z2
Institution GSTIN : Unregistered

This Proforma Invoice is Valid Till 10.05.2021.

For ICT Academy



(C. Antoine Maria Jerome)
Authorised Signatory

Submitted
to
Principal
G. S. P.



PRINCIPAL,
K S R COLLEGE OF ENGINEERING
TIRUCHENGODE 637 209
ICT A&T Coordinator
Professor & Head
Department of Information Technology

An Initiative of Government of India, State Government and Industry. An ISO 9001:2015 Certified Organisation

K.S.R. College of Engineering (Autonomous)
Tiruchengode - 637 215
Bengaluru - Chennai - Coimbatore - Guwahati - Hyderabad - New Delhi - Pune - Vijayawada
Namakkal (Dt), Tamil Nadu, India

K.S.R. COLLEGE OF ENGINEERING, TIRUCHENGODE – 637 215

DEPARTMENT OF INFORMATION TECHNOLOGY

"VALUE ADDED COURSE ON CISCO – NETACAD PYTHON"

SUPPORTED BY ICT ACADEMY OF TAMIL NADU

DURATION: 70 HOURS (12.07.2021 to 17.07.2021)

S.No.	Reg. No.	Name	ID No.	Certificate No.	Grade	Sign.
1	1921001	ABIRAMI S M	S1589260	S21-16260	C	S. M Abirami
2	1921002	ABOORVA V	S1589125	S21-16225	C	V. Aboorva
3	1921003	AKILA A	S1589145	S21-16245	C	Akila A
4	1921004	AKSHAYAA RAAJA SHRI IT	S158914	S21-1624	C	I.T. Akshaya
5	1921005	ANNA LAKSHMI S	S1589169	S21-16269	C	Anna Lakshmi S
6	1921006	ARAVIND B	S1589148	S21-16248	B	B. Aravind
7	1921007	BALAJI R	S158912	S21-1622	B	R. Balaji
8	1921008	BHUPESH G	S1589101	S21-16201	C	G. Bhupesh
9	1921009	BLESSING ANTONY G S	S1589102	S21-16202	C	G. S. Blessing Antony
10	1921010	CHITRA S	S158912	S21-1622	B	S. Chitra
11	1921011	DEEPAKKUMAR A	S158910	S21-1620	C	A. Deepakkumar
12	1921012	DHARUN B R	S1589254	S21-16254	B	B. R. Dhharun
13	1921015	DHURGADEVI S	S1589119	S21-16219	B	S. Dhurgadevi
14	1921016	DINESH R	S1589129	S21-16229	D	R. Dinesh
15	1921017	GOKUL RAJA S	S1589161	S21-16261	B	S. Gokul raja
16	1921018	GOPALAKRISHNAN S	S15891	S21-162	B	S. Gopalakrishnan
17	1921019	GOWTHAM D	S1589104	S21-16204	B	D. Gowtham
18	1921020	GUNALAN N	S1589144	S21-16244	C	N. Gunalan
19	1921021	HARIKRISHNAN S	S15891	S21-162	B	S. Hari Krishnan
20	1921024	KAMALEE S	S1589126	S21-16226	C	S. Kamalee
21	1921025	KAMALESREE P B	S1589164	S21-16264	B	P. B. Kamalesree
22	1921026	KAVIN KUMAR R	S158915	S21-1625	C	R. Kavinkumar
23	1921027	LOGESH V	S1589256	S21-16256	C	V. Logesh
24	1921028	MYILRAJ R	S1589121	S21-16221	C	R. Myilraj
25	1921029	NALLASIVAMANI P	S1589162	S21-16262	B	P. Nallasivamani
26	1921030	NANDHINI S	S1589100	S21-16200	C	S. Nandhini
27	1921031	NANDHINI S	S158918	S21-1628	A	S. Nandhini
28	1921032	NATHEEM J	S158912	S21-1622	D	J. Nathem
29	1921033	NISHANTH R	S1589166	S21-16266	B	R. Nishanth
30	1921034	PAVITHRA M	S158910	S21-1620	A	M. Pavithra

S.No.	Reg. No.	Name	ID No.	Certificate No.	Grade	Sign.
31	1921035	PRABHU G	S1589124	S21-16224	C	<i>Prabhu</i>
32	1921036	PRASANTH R	S1589154	S21-16254	C	<i>Prasanth</i>
33	1921037	PROMOTH MAHAJAN P	S1589151	S21-16251	B	<i>Promoth</i>
34	1921038	PUSHPARAJ D	S1589106	S21-16206	C	<i>P. Pushparaj</i>
35	1921039	RAGUL G	S158916	S21-1626	C	<i>Ragul</i>
36	1921040	RAHUL B	S1589105	S21-16205	C	<i>Rahul</i>
37	1921041	RAJKUMAR S	S1589146	S21-16246	B	<i>S. Rajkumar</i>
38	1921042	RAMESHKRISHNAN M	S1589142	S21-16242	C	<i>M. Ramesh</i>
39	1921043	RANJITHKUMAR T	S1589156	S21-16256	C	<i>T. Ranjith</i>
40	1921044	SANTHOSH G	S1589140	S21-16240	C	<i>G. Santhosh</i>
41	1921045	SARAVANAN B	S1589120	S21-16220	C	<i>B. Saravanan</i>
42	1921046	SASIDHARAN S	S1589128	S21-16228	B	<i>S. Sasidharan</i>
43	1921047	SNEKA B	S158910	S21-1620	B	<i>Sneka</i>
44	1921048	SOHAIL AHMED M	S1589158	S21-16258	B	<i>M. Sohail</i>
45	1921049	SOUNDAR M	S158919	S21-1629	B	<i>M. Soundar</i>
46	1921050	SOWMIYA B	S1589160	S21-16260	C	<i>B. Sowmya</i>
47	1921051	SOWMIYA N	S1589141	S21-16241	A	<i>N. Sowmya</i>
48	1921052	STEFFIGRAF R	S1589152	S21-16252	B	<i>R. Steffigra</i>
50	1921055	SURYA S	S1589108	S21-16208	C	<i>S. Surya</i>
51	1921056	THANIYEAL P	S158915	S21-1625	B	<i>P. Thaniyeal</i>
52	1921057	THAVANISH P S	S1589149	S21-16249	B	<i>P.S. Thavanish</i>
53	1921058	THINAKARAN P	S158914	S21-1624	D	<i>P. Thinakaran</i>
54	1921059	VIJAY J E	S158911	S21-1621	B	<i>J.E. Vijay</i>
55	1921060	VISHNU B	S1589122	S21-16222	B	<i>B. Vishnu</i>
56	1921501	SAKTHIVELA A	S158915	S21-1625	C	<i>A. Sakthivel</i>

Princip
Co-ordinator

(S. Gowtham)



Pr
PRINCIPAL
K.S.R. COLLEGE OF ENGINEERING
K.S.R. KALVI NAGAR,
TIRUCHENGODE-637 215

G. S. P.
12/10/2021
HoD - IT
Dr. G. Singara.
Professor & Head
Department of Information Technol
K.S.R. College of Engineering (Autonomous)
Tiruchengode - 637 215
Tirumakal (Dt), Tamilnadu, India.



Certificate of Proficiency

C. No: S21-1660

Date: 12 Oct 2021

This is to certify that

S M ABIRAMI

of KSR College of Engineering, Namakkal bearing ID S1589260

has successfully completed all the requirements for

Programming Essentials in Python

through assessment administered by ICT Academy and

has been awarded **C** Grade.

Networking
CISCO Academy

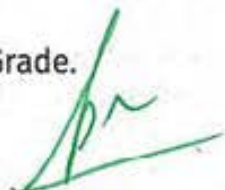

PRINCIPAL,
K.S.R. COLLEGE OF ENGINEERING
TIRUCHENGODE 637 209.

Dr. B. Anbuthambi
President, ICT Academy

PCAP: Programming Essentials in Python

Statement of Achievement

Presented To:

Abirami Sm

Name

During the Cisco Networking Academy® self-paced course, the student has studied the following Skills:

- the universal concepts of computer programming (i.e. variables, flow control, data structures, algorithms, conditional execution, loops, functions, etc.)
- developer tools and the runtime environment;
- the syntax and semantics of the Python language;
- the fundamentals of object-oriented programming and the way they are adopted in Python;
- the means by which to resolve typical implementation problems;
- the writing of Python programs using standard language infrastructure;
- fundamental programming techniques, best practices, customs and vocabulary, including the most common library function in Python 3;

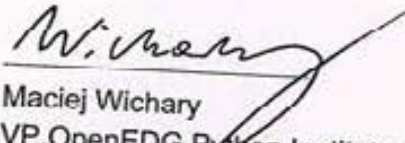
Maciej Wichary
VP. OpenEDG Python Institute



PRINCIPAL,
K'S R COLLEGE OF ENGINEERING,
TIRUCHENGODE 637 209

29 Jul 2021

Date

By completing the course, the student is now ready to attempt the qualification PCAP-Certified Associate in Python Programming certification, from the OpenEDG Python Institute.



Certificate of Proficiency

C. No: S21-16225

Date: 12 Oct 2021

This is to certify that

ABOORVA VIJAY

of KSR College of Engineering, Namakkal bearing ID S1589125

has successfully completed all the requirements for

Programming Essentials in Python

through assessment administered by ICT Academy and

has been awarded **C** Grade.

Networking
CISCO Academy



PRINCIPAL,
K S R COLLEGE OF ENGINEERING,
TIRUCHENGODE 637 209.

Ur B Anbuthambi
President, ICT Academy



PCAP: Programming Essentials in Python

Statement of Achievement

Presented To:

Aboorva Vijay

Name

During the Cisco Networking Academy® self-paced course, the student has studied the following Skills:

- the universal concepts of computer programming (i.e. variables, flow control, data structures, algorithms, conditional execution, loops, functions, etc.)
- developer tools and the runtime environment;
- the syntax and semantics of the Python language;
- the fundamentals of object-oriented programming and the way they are adopted in Python;
- the means by which to resolve typical implementation problems;
- the writing of Python programs using standard language infrastructure;
- fundamental programming techniques, best practices, customs and vocabulary, including the most common library function in Python 3;

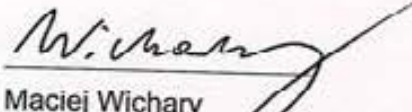
Maciej Wichary
VP, OpenEDG Python Institute



PRINCIPAL,
K. S. R. COLLEGE OF ENGINEERING,
TIRUCHENGODE - 637 209.

26 Jul 2021

Date

By completing the course, the student is now ready to attempt the qualification PCAP-Certified Associate in Python Programming certification, from the OpenEDG Python Institute.

www.netacad.com | www.pythoninstitute.org



Certificate of Proficiency

C. No: S21-16245

Date: 12 Oct 2021

This is to certify that

AKILA A

of KSR College of Engineering, Namakkal bearing ID S1589145

has successfully completed all the requirements for

Programming Essentials in Python

through assessment administered by ICT Academy and

has been awarded C Grade.

PRINCIPAL,
KSR COLLEGE OF ENGINEERING
TIRUCHENGODE - 637 209.



Dr B Anbuthambi
President, ICT Academy

Statement of Achievement

Presented To:

A Akila

Name

During the Cisco Networking Academy® self-paced course, the student has studied the following Skills:

- the universal concepts of computer programming (i.e. variables, flow control, data structures, algorithms, conditional execution, loops, functions, etc.)
- developer tools and the runtime environment;
- the syntax and semantics of the Python language;
- the fundamentals of object-oriented programming and the way they are adopted in Python;
- the means by which to resolve typical implementation problems;
- the writing of Python programs using standard language infrastructure;
- fundamental programming techniques, best practices, customs and vocabulary, including the most common library function in Python 3;

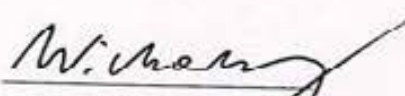
Maciej Wichary
VP, OpenEDG Python Institute



26 Jul 2021

Date

PRINCIPAL,
K.S.R. COLLEGE OF ENGINEERING
TIRUCHENGODE 637 209

By completing the course, the student is now ready to attempt the qualification PCAP-Certified Associate in Python Programming certification, from the OpenEDG Python Institute.



CTACADEMY®

SKILL TESTER
Competency Measure

Certificate of Proficiency

C. No: S21-1624

Date: 12 Oct 2021

This is to certify that

I T AKSHAYAA RAAJA SHRI

of KSR College of Engineering, Namakkal bearing ID S158914

has successfully completed all the requirements for

Programming Essentials in Python

through assessment administered by ICT Academy and

has been awarded **C** Grade.

PRINCIPAL,
KSR COLLEGE OF ENGINEERING,
TIRUCHENGODE 637 209.

Networking
CISCO Academy



Dr B Anbuthambi
President, ICT Academy

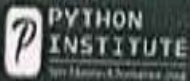

PCAP: Programming Essentials in Python

Statement of Achievement

Presented To:

Akshayaa RaaJa Shri I.T.

Name

During the Cisco Networking Academy® self-paced course, the student has studied the following Skills:

- the universal concepts of computer programming (i.e. variables, flow control, data structures, algorithms, conditional execution, loops, functions, etc.)
- developer tools and the runtime environment;
- the syntax and semantics of the Python language;
- the fundamentals of object-oriented programming and the way they are adopted in Python;
- the means by which to resolve typical implementation problems;
- the writing of Python programs using standard language infrastructure;
- fundamental programming techniques, best practices, customs and vocabulary, including the most common library function in Python 3;

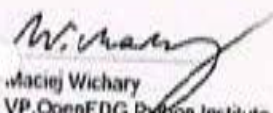
Maciej Wichary
VP, OpenEDG Python Institute

29 Jul 2021

Date

By completing the course, the student is now ready to attempt the qualification PCAP-Certified Associate in Python Programming certification, from the OpenEDG Python Institute.
www.netacad.com / www.pythoninstitute.org



PRINCIPAL,
K. S. R. COLLEGE OF ENGINEERING,
TIRUCHENGODE 637 209.



Certificate of Proficiency

C. No: S21-16269

Date: 12 Oct 2021

This is to certify that

ANNA LAKSHMI S

of KSR College of Engineering, Namakkal bearing ID S1589169

has successfully completed all the requirements for

Programming Essentials in Python

through assessment administered by ICT Academy and

has been awarded C Grade.

PRINCIPAL,
S R COLLEGE OF ENGINEERING
TIRUCHENGODE 637 009



Dr. B Anbuthambi
President, ICT Academy

Statement of Achievement

Presented To:

Anna lakshmi

Name

During the Cisco Networking Academy® self-paced course, the student has studied the following Skills:

- the universal concepts of computer programming (i.e. variables, flow control, data structures, algorithms, conditional execution, loops, functions, etc.)
- developer tools and the runtime environment;
- the syntax and semantics of the Python language;
- the fundamentals of object-oriented programming and the way they are adopted in Python;
- the means by which to resolve typical implementation problems;
- the writing of Python programs using standard language infrastructure;
- fundamental programming techniques, best practices, customs and vocabulary, including the most common library function in Python 3;

Maciej Wichary
VP, OpenEDG Python Institute



PRINCIPAL,
K.S.R. COLLEGE OF ENGINEERING,
TIRUCHENGODE 637 209.

29 Jul 2021

Date

By completing the course, the student is now ready to attempt the qualification PCAP-Certified Associate in Python Programming certification, from the OpenEDG Python Institute.

**K.S.R. COLLEGE OF ENGINEERING (Autonomous)
TIRUCHENGODE, TAMILNADU - 637 215**



DEPARTMENT OF INFORMATION TECHNOLOGY

VALUE - ADDED COURSE

**LEARNATHON
JULY 2021-SEPTEMBER 2021**

in association with

ICT ACADEMY

ELCOT Complex, 2-7 Developed Plots, Industrial Estate,
Perungudi, Chennai – 600 096.

Dr. G. SINGARAVEL
PROFESSOR AND HEAD

&

Mr. T.SARANSUJAI
ASSISTANT PROFESSOR

PRINCIPAL,
K. S. R. COLLEGE OF ENGINEERING
TIRUCHENGODE - 637 209

DEPARTMENT OF INFORMATION TECHNOLOGY
K. S. R. COLLEGE OF ENGINEERING
(Autonomous)
TIRUCHENGODE - 637 215
NAMAKKAL DISTRICT, TAMILNADU-INDIA.

JULY 2021

K.S.R. College of Engineering (Autonomous) , Tiruchengode - 637 215
Department of Information Technology
New India Learnathon 2021 Organised by ICT Academy
July'2021 - September'2021

S. No.	Register Number	Name of the Student	Course Partner with Hours								Total No. of Hours Attended	Certificate No.
			Automation Anywhere	Celonis	CISCO	MathWorks	Microsoft	PrimeSc	Qlik	VMWare		
			10	15	30	2	9	4	15	9		
1	2021001	ABISHEK U	YES	YES	YES	YES	NO	YES	NO	YES	70	LUB155682
2	2021002	ABISHEK R S	YES	YES	NO	YES	NO	NO	NO	YES	36	LUB238166
3	2021008	DHANUSHYA K	YES	YES	YES	YES	YES	YES	NO	YES	79	LUB140384
4	2021057	VIGNESH S	YES	YES	YES	YES	NO	YES	NO	YES	70	LUB140323
5	2021019	HARIPRASATH S	YES	YES	YES	NO	NO	YES	NO	YES	68	LUB155220
6	2021040	PRIYANKA P	YES	YES	YES	NO	NO	YES	NO	YES	68	LUB155525
7	2021060	YUVASREE S	YES	YES	YES	YES	YES	YES	NO	YES	79	LUB140447
8	2021005	BHARATHI P	YES	YES	YES	NO	NO	YES	NO	YES	68	LUB184595
9	2021051	SURRIYAA PP	YES	YES	YES	NO	NO	YES	NO	YES	68	LUB156053
10	2021015	GOKUL R	YES	YES	YES	YES	YES	YES	NO	YES	79	LUB140457
11	2021034	PAVITHRA S	YES	YES	YES	YES	NO	YES	NO	YES	70	LUB143097
12	2021009	DIVYA K	YES	YES	YES	YES	NO	YES	NO	YES	70	LUB140499
13	2021012	GIRIJA V	YES	YES	YES	NO	NO	YES	NO	YES	68	LUB140597
14	2021036	POOVARASAN G	YES	YES	YES	YES	YES	YES	NO	YES	79	LUB238887
15	2021028	MANIBHARATHI J	YES	YES	YES	YES	NO	YES	NO	YES	70	LUB155307
16	2021048	SHEVAKSRI P	YES	YES	NO	YES	YES	YES	NO	YES	49	LUB149803
17	2021026	LALITHKUMAR R	YES	YES	YES	YES	YES	NO	NO	YES	75	LUB155374
18	2021031	MOHAMEDFAHEEM	YES	YES	YES	YES	YES	YES	NO	YES	79	LUB149260
19	2021055	VASANTH V	YES	YES	YES	YES	YES	YES	NO	YES	79	LUB155219
20	2021021	KALPANA V	YES	YES	YES	YES	NO	YES	NO	YES	70	LUB238562

21	2021058	VIGNESH C	YES	YES	YES	YES	YES	YES	NO	YES	79	LUB155408
22	2021035	POOVARASAN G	YES	YES	YES	YES	NO	YES	NO	YES	70	LUB155339
23	2021033	NITHEESHKUMAR A	YES	YES	NO	YES	YES	YES	NO	YES	49	LUB155732
24	2021023	KAVIN S	YES	YES	YES	YES	YES	YES	NO	YES	79	LUB155356
25	2021042	RITHISH R V	YES	YES	YES	YES	YES	YES	NO	YES	79	LUB155190
26	2021049	SRITHAR S V	YES	YES	YES	NO	NO	YES	NO	YES	68	LUB155281
27	2021014	GOBIKA C	YES	YES	YES	YES	NO	YES	NO	YES	70	LUB137626
28	2021050	SUGANESH G	YES	YES	YES	YES	YES	YES	NO	YES	79	LUB141383
29	2021054	VASANTH P	YES	YES	YES	YES	YES	YES	NO	YES	79	LUB155404
30	2021052	SUWETHAA M K	YES	YES	YES	YES	YES	YES	NO	YES	79	LUB155764
31	2021020	HARIPRIYA G	YES	YES	YES	YES	NO	YES	NO	YES	70	LUB277945
32	2021013	GNANAPRAKASH J	NO	YES	NO	YES	YES	YES	NO	YES	39	LUB158001
33	2021038	PRAVEENKUMAR V	YES	YES	YES	YES	NO	YES	NO	YES	70	LUB155262
34	2021025	KISHORE B	NO	YES	YES	NO	YES	YES	NO	YES	67	LUB141339
35	2021022	KANISHKA V	YES	YES	NO	YES	YES	YES	NO	YES	49	LUB147919

G. S.

Dr. G. Singaravel
Professor & Head
 Department of Information Technol
 K.S.R. College of Engineering (Autono.
 Tiruchengode - 637 215
 Namakkal (Dt), Tamilnadu, India.



pr

PRINCIPAL,
K S R COLLEGE OF ENGINEERING
TIRUCHENGODE 637 209



CERTIFICATE OF PARTICIPATION

Proudly presented to

RITTHISH RV

For successful participation in New India Learnathon 2021

Organised by ICT Academy during July - September 2021

In partnership with



C.No: LUB155190 | Date : 30 Sep 2021



Dr B Anbuthambi
President, ICT Academy

PRINCIPAL,
K S R COLLEGE OF ENGINEERING
TIRUCHENGODE 637 209



DISCOVER THE NEW WAY OF LEARNING



CERTIFICATE OF PARTICIPATION

Proudly presented to

SANJAY J

For successful participation in New India Learnathon 2021

Organised by ICT Academy during July - September 2021

In partnership with

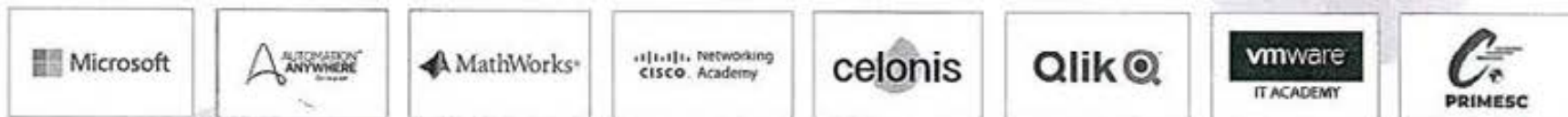

C.No: LUB265959 | Date : 30 Sep 2021



Dr B Anbuthambi
President, ICT Academy
PRINCIPAL,
K J S R COLLEGE OF ENGINEERING,
TIRUCHENGODE - 637 203.



DISCOVER THE NEW WAY OF LEARNING



CERTIFICATE OF PARTICIPATION

Proudly presented to

SHARVESH.M

For successful participation in New India Learnathon 2021

Organised by ICT Academy during July - September 2021

In partnership with

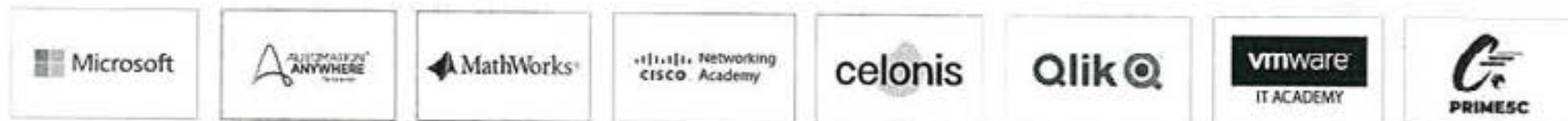

C.No: LUB155366 | Date : 30 Sep 2021



Dr B Anbuthambi
President, ICT Academy

PRINCIPAL,
K. S. R. COLLEGE OF ENGINEERING
TIRUCHENGODE - 637 207



DISCOVER THE NEW WAY OF LEARNING



ICTACADEMY®

CERTIFICATE OF PARTICIPATION

Proudly presented to

SUWETHAA MK

For successful participation in New India Leamathon 2021

Organised by ICT Academy during July - September 2021

In partnership with

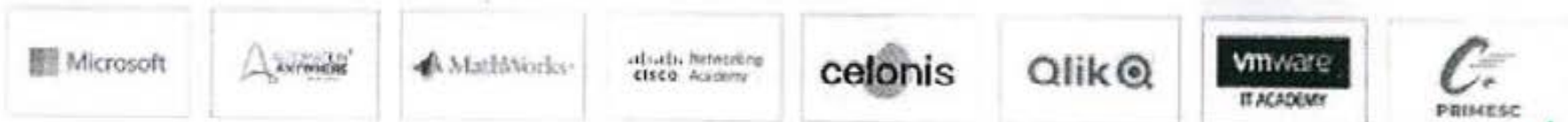

C.No: LUB155764 | Date : 30 Sep 2021



B. Anubuthambal

Dr B Anubuthambal
President, ICT Academy PRINCIPAL,

K S R COLLEGE OF ENGINEERING
TIRUCHENGODE - 637 209



DISCOVER THE NEW WAY OF LEARNING



ICTACADEMY®

CERTIFICATE OF PARTICIPATION

Proudly presented to

YUVASREE S

For successful participation in New India Learnathon 2021

Organised by ICT Academy during July - September 2021

In partnership with

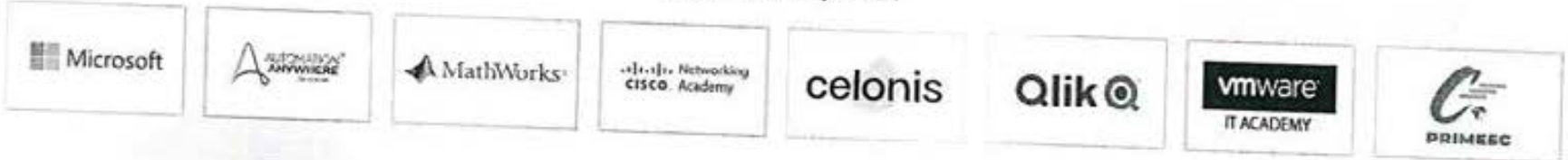

C.No: LUB140447 | Date : 30 Sep 2021



B. Anbutambi

Dr B Anbutambi
President, ICT Academy

[Signature]
PRINCIPAL

K S R COLLEGE OF ENGINEERING
TRICHENGODE - 637 209

**K.S.R. COLLEGE OF ENGINEERING (Autonomous)
TIRUCHENGODE, TAMILNADU - 637 215**



**DEPARTMENT OF INFORMATION TECHNOLOGY
VALUE - ADDED COURSE**

**Corporate Communication Skill For
Bengineers**

09.05.2022 - 13.05.2022

in association with

UNBORN SOLUTIONS LLP

NO.1-2nd Street Ramesh Nagar Extension,
West Tambaram , Chennai-600 045.

**Dr. G. SINGARAVEL
PROFESSOR AND HEAD
&**

**Mr. T.SATHISH KUMAR
ASSISTANT PROFESSOR**

**DEPARTMENT OF INFORMATION TECHNOLOGY
K. S. R. COLLEGE OF ENGINEERING
(Autonomous)**

**TIRUCHENGODE - 637 215
NAMAKKAL DISTRICT, TAMILNADU-INDIA.**

**PRINCIPAL,
K.S.R. COLLEGE OF ENGINEERING,
TIRUCHENGODE - 637 215**

MAY 2022

**K. S. R. COLLEGE OF ENGINEERING (Autonomous)
TIRUCHENGODE – 637 215**

Department of Information Technology

Check List for Event / Programme Organized

1. Name of Event/ Programme : Seminar
 Workshop
 Value Added Course
 Guest lecturer
 Training and Placement Oriented Programme
 Industries Series/ Talk Lecturer
 Students Skill Development (SSD)
 Symposium (National / International)
 Conference (National / International)
 Alumni Lecture Series
 Alumni Meet
 Parent's Meet

2. Name of the Faculty Coordinator/ Chairperson/ Convener : *Dr. G. Singaravel
Mr. T. Sathishkumar*

3. Name of Event / Program / Title : *Corporate Communication Skill for
Beginners.*

4. Mode of conducting : Physical Online

5. Approval Type : Self Organization
 AICTE / DST / SERB
 Anna University
 Professional Bodies
 Government Funding

- Alumni Sporesed
 Any Other
 6. Approval Letter : Yes No
 7. Chair / Principal Approval : Approval Not Approval
 (Attach Approval Letter)
 8. Brochure : Yes No
 9. Poster / flux : Yes No
 10. Invitation : Yes No
 11. Resource person Chief guest/
 Session Chair/ Keynote Speaker : Yes No
 Letter Communication
 12. Sample PPT / Document / PDF : Yes No
 13. Registration & List of Participants: Yes No
 14. Feedbacks : Yes No
 15. Photos : Yes No
 16. Bill Settlement Copies : Yes No
 17. Utilization Certification : Yes No
 18. Report : Yes No
 19. Sample Certificate : Yes No

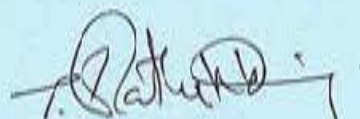
 Faculty Coordinator
 Chairperson/ Convener
T. SATHISH KUMAR

 Head of the Department
Dr. G. Singaravelu
 Professor & Head
 Department of Information Technology
 K.S.R. College of Engineering (Autonomous)
 Tiruchengode - 637 215
 Namakkal (Dt), Tamilnadu, India.



 Principal
PRINCIPAL,
 K.S.R. COLLEGE OF ENGINEERING
 TIRUCHENGODE 637 205

K.S.R. COLLEGE OF ENGINEERING (Autonomous): TIRUCHENGODE - 637 215

Date: 02-05-2022

Time: 11.00 a.m.

CIRCULAR

Classification	ROUTINE ✓	IMMEDIATE
ORIGINATOR:HOD- IT		CIRCULATED TO: B.Tech. IT (I &II Year)

Sub: VALUE ADDED COURSE 2021-2022 - Reg.

There will be a Valued Added Course for B.Tech I.T (I-Year & II-Year) for the academic year 2021-2022 on topic of "CORPORATE COMMUNICATION SKILL FOR BEGINNERS " from 09.05.2022 (Monday) to 13.05.2022 (Friday), Time 1.30 pm-5.30pm at Class Room F-104 (F-Block) & English Language Lab (A- Block) respectively. All the Willing students should register their name to Course Coordinator Mr.T.Sathish kumar, Assistant Professor/IT. The resource person and other details are given below.

Resource Person:

1. Mr.R.Krishna pradeep
Professor and Head,
Department of English,
K.S.R College of Engineering,
Tiruchengode- 637215.
2. Kaveen Prasanamoorthy,
Managing Partner,
Unborn Solutions LLP,
No1, 2nd Street, Ramesh Nagar Extension,
West Tambaram, Chennai-600 045.
(Alumni of 2006-2010)

Course Coordinator:

1. Dr. G. Singaravel
Professor Head - IT
2. T.Sathish Kumar
Assistant Professor-IT

Note : Maximum of Register Capacity: 90 Students**Instructions to the students through Course Coordinator**

1. Dress Code (Self Grooming, Formal wear with shoes)
2. Discipline and attendance is compulsory to attend the program.
3. Punctuality

If any student not follows the above he/she may not be allowed to proceed further.

PRINCIPAL,
K.S.R. COLLEGE OF ENGINEERING
K.S.R. KALVI NAGAR,
TIRUCHENGODE-637 215



G. F. Sathish Kumar
4/5/22

G. HOD/IT.

Professor & Head
Department of Information Technology,
K.S.R. College of Engineering (Autonomous)
Tiruchengode - 637-215
Namakkal (Dt), Tamil Nadu, India.

EVIDENCE OF COMPLETIONNumber of persons not received / seen: - 15/2Signature of Originator with Date and time. 4/5/22

K.S.R. COLLEGE OF ENGINEERING (Autonomous)

(An Autonomous Institution, approved by AICTE, Accredited by NAAC with A grade
& Affiliated to Anna University)

**K.S.R. Kalvi Nagar, Tiruchengode – 637 215,
Namakkal District, Tamil Nadu**

Phone: 04288-274213

Fax: 04288-274757

E - mail: principal@ksrce.ac.in

Department of Information Technology

Phone :9943455245(HoD)

e - mail:ksrceitdept@gmail.com

Date: 03.05.2022

Submitted to Principal:

Sub.: Permission for conducting Value Added Course on “Corporate Communication Skill for Beginners”-
Reg.

Respected sir,

Our department conducted for Second and Third Year B.Tech I.T students on the topic of “Corporate Communication Skill for Beginners” from 09.05.2022(Monday) to 13.05.2022(Friday), Time 1.30p.m-5.30p.m(AN) at Class Room F-104(F-Block) and English Language Lab(A-Block) , KSRCE. Hence, We request to give me permission for the same.

Thanking You,

1. Mr.R.Krishna Pradeep,
Professor and Head-English,
K.S.R College of Engineering,
Tiruchengode-637215.
2. Kaveen Prasanamoorthy,
Managing Partner,
Unborn Solutions LLP,
No1, 2nd Street,
Ramesh Nagar Extension,
West Tambaram,Chennai-600 045.
(Alumni of 2006-2010)

1. Dr.G.Singaravel
Professor and Head – IT
2. Mr.T.Sathish kumar
Assistant Professor-IT



Copy to:

Association file & HoD file

Course Co-ordinator

T.SATHISH KUMAR

Signature of HOD

Dr. G. Singaravel
Professor & Head
Department of Information Technology,
K.S.R. College of Engineering (Autonomous),
Tiruchengode - 637 215
Namakkal (Dt), Tamilnadu, India.

Principal

PRINCIPAL
K.S.R. COLLEGE OF ENGINEERING
K.S.R. KALVI NAGAR,
TIRUCHENGODE-637 215

K.S.R. COLLEGE OF ENGINEERING (Autonomous)

(An Autonomous Institution, approved by AICTE, Accredited by NAAC with A grade
& Affiliated to Anna University)

**K.S.R. Kalvi Nagar, Tiruchengode – 637 215,
Namakkal District, Tamil Nadu**

Phone: 04288-274213

Fax: 04288-274757

E - mail: principal@ksrce.ac.in

Department of Information Technology

Phone :9943455245(HoD)

e - mail:ksrceitdept@gmail.com

Date: 04-05-2022**Value added Course****On****“Corporate Communication skill for Engineers”****Objective of this course:**

- Its Aim to provide students with the skills and knowledge of communication in the business environment. There is a strong focus on the understanding the theory of communication in the business context and it's application to effective business writing at a high level, persuasive and appropriate verbal and non verbal communication, and interpersonal skills across teams and cultures. To achieve this students undertake the role of a new graduate employee in the workplace and develop responses to a range of current and emerging business issues that they will encounter in the private and public sector.
- Students will use the workplace case study to develop knowledge and high level skills in business writing, and will assemble a portfolio of key written business documents to demonstrate capability to prospective employees. This will include short reports, memorandums, business letters, action plans and formal long reports.
- Effective interpersonal communication skills are basic tools for those employed in professional fields. The workshop format of the tutorials explores business communication theory, and develops the student's communication skills and knowledge in a supportive peer group environment through ideas exchange and argument, and team approaches to workshop activities and team leadership. There is a strong focus on self development.

Through this course students will be able to:

- Effective business writing
- Effective business communications
- Research approaches and information collection
- Developing and delivering effective presentations
- Effective interpersonal communications
- Skills that maximise team effectiveness
- Good time management
- Effective problem solving

COURSE CO-ORDINATOR
T. SATHISH KUMAR

Dr. G. Singaravel
Professor & Head

Department of Information Technology
K.S.R. College of Engineering (Autonomous)
Tiruchengode - 637 215
Namakkal (Dt), Tamilnadu, India.



PRINCIPAL

PRINCIPAL,
K.S.R. COLLEGE OF ENGINEERING,
TIRUCHENGODE - 637 209.

CURRICULAM VITAE

Dr.G.SINGARAVEL, BE., ME., Ph.D., MISTE.,MCSI.,



Professor & Head

Department of Information Technology
K.S.R. College of Engineering (Autonomous)
Tiruchengode- 637 215
Namakkal District, Tamilnadu, India.

Mobile: +91 - 9943455245

Res. Ph: 04256 230194

E-mail: singaravelg@gmail.com

hodit@ksrce.ac.in

URL: Singaravel.in

Dr. G. SINGARAVEL received the D.C.T degree in Computer Technology in 1995 from Kongu Polytechnic College and the Undergraduate degree B.E. (Electronics and communication and Engineering) in 1999 in Kongu Engineering College from the Bharathiyar University. He completed his master degree M.E. (Computer Science and Engineering) in 2002 at Arulmigu Kalasalingam College of Engineering from Madurai Kamaraj University. He received his Ph.D. degree in the area of Information and Communication from Anna University, Chennai in 2010. He has 22 years of teaching experience. He is a Professor and the Head of the Department of Information Technology, K.S.R College of Engineering (Autonomous), Tiruchengode. He is recognizing as a Supervisor for Ph. D Programme and M.Tech (By Research) in Computer Science and Engineering at Anna University, Chennai. He is trained certificate holder of 'High Impact Teaching Skills' through Wipro Mission 10X and Trained Evaluator & Resource Person of NBA (National Board of Accreditation) by AICTE, New Delhi. Chief Advisor for Technology Updates and Monitoring Overseas at client project at Accrete Software services & Resource, Chennai. He is in the editorial board member of 6 International/National Journals. He has published 60 papers in international, national journals and conference proceedings and having Google Scholar citations and h-index. He has guided 30 Master Degree projects. He is Guiding 17 PhD research scholars in various domains and 8 Research scholar were Completed.His areas of research include Software Engineering, Agile Project Management, Green &Cloud Computing, Big Data Analytics, etc.,

I am happy to share that 08 Ph.D. scholars have completed under my supervision. In my past, I have headed the role for supporting Information Technology Department for getting NBA in 2008, 2012.

The highlights of my contribution include – Member of Board of members for KSR Collage of Engineering for NAAC. I had the opportunity to learn, understand and contribute in accreditation process as a steering committee head, I am happy to inform that our institute has got accredited with status 'A' during NAAC visit -2017. Currently Chairman for Computer Society of India(CSI), Salem Chapter.

As a part of the education community, I am interested to share my learnt experience to my academic contacts.

Academics Experience

Teaching Experience : 23 Years

After Ph.D : 10 Years, 7 Months

Achievement	
Teaching Experience	: 22 Years
Patent Granted & Published	: 04
Book published	: 03
Indexed Journal	: 20
Ph.D. Research Completed	: 08
Research and Funding Agency (R&D)	
AICTE (RPS/FDP/STP)	: 03
SERB-DST	: 01
CSRI	: 01
CSI	: 08
Anna University	: 02
DIT	: 01
Consultancy Projects	: 03
Sessions/Symposium Organized	: 25
President of Society	: 01
Membership in Professional Bodies	: 04
Faculty Development Program Organized	: 10
Session Chaired in Conferences	: 10
National Conference Organized	: 02
International Editorial Board	: 19
International Conference Organized	: 03
National Workshops/Seminars Organized	: 22
International Journal Publications	: 50
National Journal Publications	: 02
International Conferences	: 18
National Conferences	: 12
National/International Workshop attended	: 30
National/International SDP/FDP attended	: 09
Project guided for Post Graduate level	: 10
Project guided for Under Graduate level	: 25
Mini Project guided for Under Graduate level	: 10
Awards	: 03

Research Scholar Details

Number of PhD Scholars					
SRL. NO	Status	Research Area	Regno	Name of the Scholar	University
1	Completed	Data Mining and Data Warehousing	11260631045	Prakash M	Anna University
2	Completed	Computer Network	10960121034	Dhanasekaran R	Anna University
3	Thesis Submitted	Image processing	11260531049	Paneer Selvam R	Anna University
4	Confirmation Completed	Data Mining	17134691241	Tamilarasu P	Anna University
5	Confirmation Completed	Big Data	17134691345	Arunkumar K.G	Anna University
6	Completed	Software Engineering	71130631021	Karuppusamy S	Anna University
7	Completed	Software Engineering	71130631047	Sakthivel M	Anna University
8	Completed	Wireless Sensor Network	71160531006	Eswaramoorthi R	Anna University
9	Completed	Wireless Sensor	71160531045	Sachidhanandam P	Anna University

		Network			
10	Confirmation Completed	Cloud Computing	D14CS019	Rajesh M	Bharth University
11	Confirmation Completed	Cloud Computing	D14CS011	Senthil J	Bharth University
12	Thesis Submitted	Image Processing	17234697430	Kanimozhi N	Anna University
13	Thesis Submitted	Data Mining	1423469728	Kavitha N.S	Anna University
14	Completed	Virtualization	1414439913	Gokuldhev M	Anna University
15	Completed	Geo-Computing	16134697396	Nithyanantham S	Anna University
16	Confirmation Completed	Image Processing	18244697159	Revathi M	Anna University
17	Course Work	Artificial Intelligent	21194691511	Praveen Kumar K	Anna University
18	Course Work	Big Data Analytic	21144697188	Kaveen P	Anna University
19	Course Work	Computer Network	21194697406	P.N.V.Sivakumar	Anna University
20	Course Work	Computer Network	21254697668	Yarlagadda Sirisha	Anna University

Professional Details

- **Since July 1, 2011: Professor and Head** in Department of Information Technology, K.S.R. College of Engineering (Autonomous), Tiruchengode, Affiliated to Anna University, Chennai.
- **From July 2003 - June 2011: Professor and Head** of the Department of Computer Science and Engineering, K.S.R. College of Engineering, Tiruchengode, Affiliated to Anna University of Technology, Coimbatore.
- **From Jan 2002 - May 2003: Lecturer** in the department of Computer Science and Engineering, Dr. M.G.R. Engineering College, Chennai, Affiliated to Anna University, Chennai.
- **From Jun 1999 - Jan 2002: Lecturer** in the department of Computer Science and Engineering, Jaya Engineering College, Chennai, Affiliated to Anna University, Chennai.

Pedagogic Details			
Degree qualification	Institute/University	Percentage	Year of passing
Ph.D. (Information and Communication)	Anna University, Chennai	Highly Recommended	Nov 2010
M.E. (Computer Science and Engineering)	Arulmigu Kalasalingam College of Engineering, Krishnankovil, Madurai (Dt) Tamilnadu, India, Madurai Kamaraj University, Madurai	82%	April 2002
B.E (Electronics and Communication Engineering)	Kongu Engineering College, Perundurai, Erode (Dt), TamiNadu, India, Bharathiyar University, Coimbatore	67%	May 1999
D.C.T (Computer technology)	Kongu Polytechnic, Perundurai, Erode (Dt), Tamilnadu, India Direct of Technical Education, Chennai	74%	April 1995

Computer Proficiency	
Technology	Resources
Operating system	Windows NT Server, Windows 7/XP /95/98/2000, DOS
Languages	C, C++, JAVA, Dot Net, Python
Scripting Languages	ASP, XML, HTML, JAVA SCRIPT
Network Technology	TCP/IP, LAN, WAN, Distributed System, CORBA, COM & DCOM, INTERNET
Front End Tool	VB 6.0
Testing Tool	Win Runner, Load Runner, Risk Rader, Weka
Packages	Microsoft Office 2007/2010

Academic Specializations	
Research Specialization	Subject specialization
<ul style="list-style-type: none"> • Software Engineering • Agile Methodologies • Software Testing • Information Security • Agile Methodologies • Object oriented Analysis • Design and Programming • Cloud Computing • Big Data Analytics 	<ul style="list-style-type: none"> • Fundamentals of Computing • Embedded systems • Computer Architecture • Mobile computing Apps • Data Structure • Software Quality Management • Project Management • Projects works

Membership in Professional Bodies

- Life member - ISTE (LM38394), 2003 onwards
- Life member - CSI (00153292), 2004 onwards
- Life member – ISRD (F3140900610), 2016 onwards
- Vice- President of Computer Society of India (CSI), Salem Chapter, and Tamilnadu – 2012 to 2016.
- President in Computer Society of India (CSI), Salem Chapter, Tamilnadu. – 2018 to 2023.

Major Position Held

- Chief-Coordinator for NAAC: College level, K.S.R. College of Engineering (Autonomous), Period 2013-2017.
- Chief-Coordinator for NBA – College level, K.S.R. College of Engineering (Autonomous), from 2008 onwards.
- Best student Project selection committee member (Namakkal District) headed by district collector of Namakkal for 2015-2016 appointed by Government of Tamilnadu.
- Chairman – Board of Studies (BOS), Department of Information Technology, K.S.R. College of Engineering (Autonomous), Period 2011-2013 & 2013-2017, 2018-2021 to till date.
- Co-opted External Expert – Academic Council, Autonomous Body and BOS of Computer Science and Engineering (UG & PG) at K.S. Rangasamy college of Technology (Autonomous), Tiruchengode.
- Member- Staff Selection Committee, K.S.R. College of Engineering, Tiruchengode.

- **Coordinator of ICT Academy Tamil Nadu, EDP Cell (Funded by Government of Tamilnadu),** K.S.R. College of Engineering, Tiruchengode.
- **Coordinator for Industry Institute Partnership Cell (IIPC),** K.S.R. College of Engineering, Tiruchengode.
- **Member Question paper Setting Committee -** Karunya University, Dr.M.G.R.University, Karpagam University, Sastra University, Kumaraguru College of Technology (Autonomous), Kongu Engineering College (Autonomous), Chandrasekara Vidyala University, Sona college of Technology (Autonomous), Government College of Engineering (Autonomous), Annamalai University.
- Mock interview – PANEL Member for Wipro-Training for 2017-2018.
- Training & Placement Head at KSRCE-2019 to till date.

Ph.D. Supervision Recognition		
Name of the University	Recognition Number	Approved Departments
Anna University, Chennai	1006101 / 2740085	Computer Science and Engineering, Information Technology, Electronic and Communication Engineering
Bharath University, Chennai	R14CS011	Computer Science and Engineering
VIT University, Vellore	1102433	Computer Science and Engineering.

Award & Recognitions

- Got **Best International Journal Paper** award for "A Tool for Testing Inheritance Related Bugs in Object oriented Software" in Directory of open access journal, SPARC EUROPE AWARD 2009.
- Management Information System – Oct 2005 – 100% Result, Anna University ,Chennai
- Management information system –Dec 2006 – 100% Result, Anna University ,Chennai
- Software testing - April 2006 – 100% Result, Anna University ,Chennai
- Software testing - May2007 – 100 % Result, Anna University ,Chennai
- Computer Programming - May 2007- 100% Result, Anna University ,Chennai
- Software engineering –May 2009 – 100 % Results, Anna University of Technology, Coimbatore.
- Software quality Management –April 2010 – 100 % Results, Anna University of Technology, Coimbatore.
- Advanced computer Architecture – November 2011 -100 % results, Anna University of Technology, Coimbatore.
- Software Engineering Methodology – December 2014 – 100% results, Anna University, Chennai.
- **Best Teaching awards in Engineering for 2015** from Staffordshire University, UK and Education Matters.
- **Award for Achievements in Organizing FDP/Conferences** for 2014-15 from K.S.R. College of Engineering (Autonomous), Tiruchengode.
- **Best support award** for International Conference on Advanced Theoretical computer Applications (ICATCA'16),organized by CAASR Publishers held at Kuala Lumpur , Malaysia on 5th & 6th May 2016.

Profile Outlook

Educator with over 13 years of experience who possesses the technical, interpersonal, and demonstration skills to successfully contribute to an academic institution.

Professional Summary

- 13 Years of professional experience as an academician in handling courses like Theory of Computation, Compiler Design, Object Oriented Programming using Java, Data Structures and Algorithms, Computer Architecture and business Intelligence.
- Strong technical expertise in Structured and Object Oriented Programming, Automation and Manual Testing, PL SQL Programming.

Technical Proficiency

- Databases : Oracle RDBMS 11g, MS Access
- Languages : C , Java, Python
- Scripting : SQL, PL SQL, UNIX Shell Scripting
- Query Tool : SQL Developer, SQLPlus
- Testing : Manual and Automation : Selenium

Educational Credentials

- **Masters of Engineering** , *Computer and Communication Engineering* ,
Mahendra Engineering College (Anna University), 8.36 CGPA , May 2012.

Certification

- **Oracle Certified Associate Java SE 8 Programmer - October 2018**

Personal Details

- Date of Birth : 7th April , 1983
- Languages Known : English & Tamil
- Passport Number : T1970780



Dr. G. Singarav
Professor & Head
Department of Information T
K.S.R. College of Engineering (Aut.)
Tiruchengode - 637 205

PRINCIPAL
K.S.R. COLLEGE OF ENGINEERING
TIRUCHENGODE - 637 205



30th May, 2022

Ref: UBS/ 2022/Training/05

TO WHOMSOEVER IT MAY CONCERN

I would like to express my heartfelt thanks to you for giving me the opportunity to conduct Value Added Course at K.S.R College of Engineering, Tiruchengode on “Corporate Communication Skill for Beginners”.

I really appreciate the time that I spent working with you, on both a professional and personal level.

And especially, thank you for choosing me to for this **Hands-on training session for B.Tech (IT) – First and Second Student for 05 days from 09th May 2022 to 13th May 2022 for 40Hrs.**

Regards

Kaveen Prasannamoorthy,
Managing Partner

9894398422



Branch Office: 1, 2nd street, Ramesh Nagar Extension, West Tambaram, Chennai 600045.

16, K.K. Complex, Near Arun Ice Cream, Opp to G.H., Tiruvannamalai Main Road, Uthangarai, Krishnagiri (Dt.) 635207

Mobile : +91 96888 62676, +91 96988 62676 || Tel. : 04341 222775 || Email : unbornsolutions@gmail.com

5 Ways to Be an Active and Effective Listener

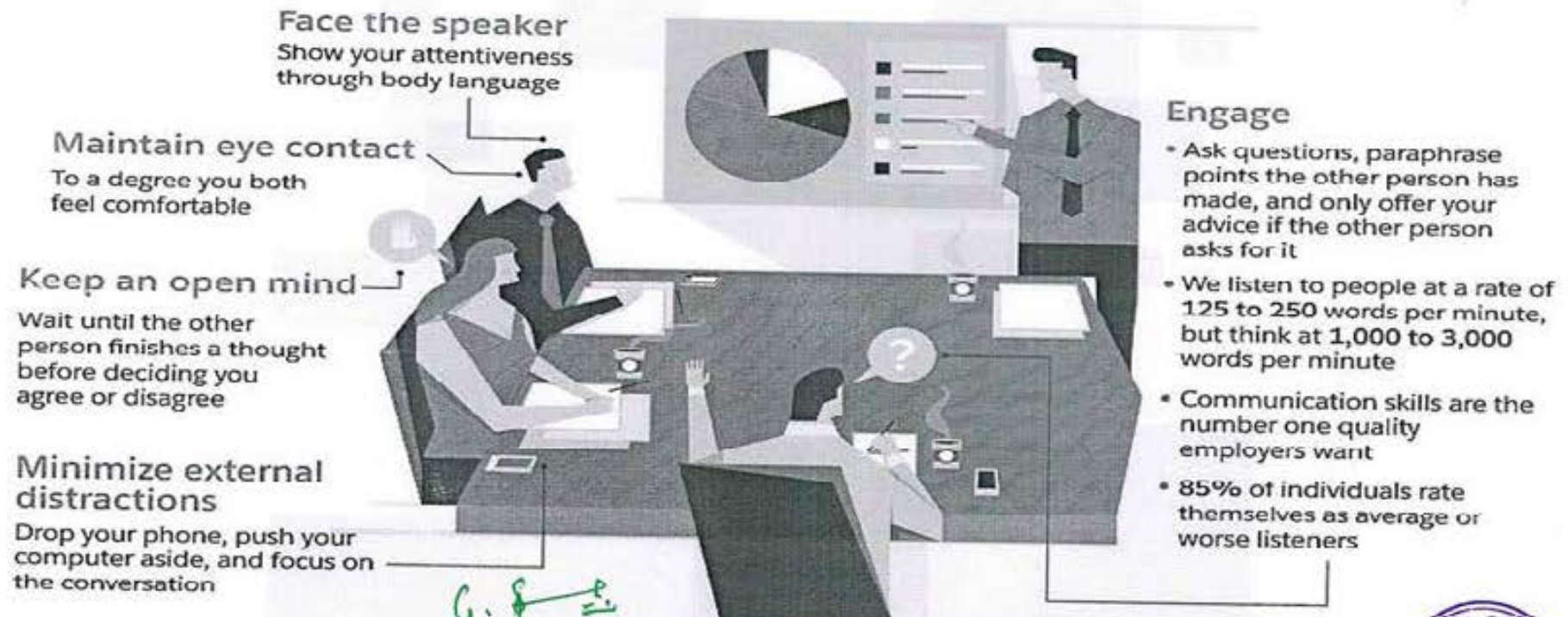

Face the speaker
Show your attentiveness through body language

Maintain eye contact
To a degree you both feel comfortable

Keep an open mind
Wait until the other person finishes a thought before deciding you agree or disagree

Minimize external distractions
Drop your phone, push your computer aside, and focus on the conversation

Engage

- Ask questions, paraphrase points the other person has made, and only offer your advice if the other person asks for it
- We listen to people at a rate of 125 to 250 words per minute, but think at 1,000 to 3,000 words per minute
- Communication skills are the number one quality employers want
- 85% of individuals rate themselves as average or worse listeners

G. Singaravel
Dr. G. Singaravel
Professor & Head
Department of Information Technology
V.S.R. College of Engineering (Autonomous)
Tiruchengode - 637 215
Namakkal (Dt), Tamilnadu, India.



K.S.R COLLEGE OF ENGINEERING (AUTONOMOUS), TIRUCHENGODE – 637215

DEPARTMENT OF INFORMATION TECHNOLOGY

A VALUE ADDED COURSE ON “CORPORATE COMMUNICATION SKILL FOR BEGINNERS”



Date:05.05.2022

It is planned to conduct value added course on the topic “Corporate Communication Skill for Beginners” for second and ~~First~~ Year students from 09.05.2022 to 13.05.2022. The following students have registered for the course.

S. No.	REG.NO	Name of the Student	Branch / Year	SIGNATURE
1.	73152121002	AJAY SUNDAR S M	B.TECH I YR	S.M. Ad
2.	73152121003	AKILAN K	B.TECH I YR	K. Akilan
3.	73152121004	ARJUNAN S	B.TECH I YR	Arjuna
4.	73152121005	ARSHAD AHAMAD J	B.TECH I YR	A. Arshad
5.	73152121006	ARUNA R V	B.TECH I YR	Aruna
6.	73152121007	BALAJI S	B.TECH I YR	B. Balaji
7.	73152121008	BHARATH R [RAVICHANDRAN]	B.TECH I YR	R. Bharath
8.	73152121009	BHARATH S	B.TECH I YR	Bharath
9.	73152121010	BHARATHAN.V	B.TECH I YR	V. Bharath
10.	73152121011	BHARATHKUMAR S	B.TECH I YR	S. Bharath
11.	73152121012	BOOMIKA K	B.TECH I YR	K. Boomika
12.	73152121013	BRINDHA R	B.TECH I YR	R. Brindha
13.	73152121014	DARUNIKA B	B.TECH I YR	B. Darunika
14.	73152121015	DAYANIDI G V	B.TECH I YR	G. Dayanidi
15.	73152121016	DEEPAKARAN S	B.TECH I YR	S. Deepak
16.	73152121017	DEEPTHI R	B.TECH I YR	R. Deepthi
17.	73152121018	DEETCHANA V	B.TECH I YR	V. Deetchana
18.	73152121019	DEVADHARSHINI M	B.TECH I YR	M. Devadharshini
19.	73152121020	DHANUSH CHANDAR N A	B.TECH I YR	N. Dhannush
20.	73152121021	DILIP S	B.TECH I YR	S. Dilip
21.	73152121022	ELIZABETH R	B.TECH I YR	R. Elizabeth
22.	73152121041	NITHISH K	B.TECH I YR	K. Nithish
23.	73152121042	NITHISH N	B.TECH I YR	N. Nithish
24.	73152121043	NIVETHA S	B.TECH I YR	S. Nivetha

25.	73152121044	PRAKASH..K	B.TECH I YR	Prakash . K.
26.	73152121045	RAHMAN BASHA S	B.TECH I YR	S. Ray . S.
27.	73152121046	RAMSURYA J	B.TECH I YR	R.
28.	73152121047	SAKTHIVEL S	B.TECH I YR	S. S. S.
29.	73152121048	SANJAY B	B.TECH I YR	B. Sanjay .
30.	73152121049	SANTHOSH KUMAR S	B.TECH I YR	S. S. S.
31.	73152121050	SARAN M S	B.TECH I YR	M. S. S. S.
32.	73152121051	SASIDHARAN.E	B.TECH I YR	E. S. S.
33.	73152121052	SHREE HAREETH S K	B.TECH I YR	S. H. S. K.
34.	73152121053	SIDHANANTH R	B.TECH I YR	R. Sidhananth
35.	73152121054	SIVABALAN K	B.TECH I YR	K. Sivabalan
36.	73152121055	SIVADHARANI S	B.TECH I YR	S. S.
37.	73152121056	SRIDHAR S	B.TECH I YR	S. S.
38.	73152121057	SUBASH B	B.TECH I YR	B. Subash .
39.	73152121058	SUBASH .S	B.TECH I YR	S. S.
40.	73152121059	THASVINTHRAGUL S	B.TECH I YR	S.
41.	73152121060	THIRUMURUGAN T	B.TECH I YR	T. M.
42.	73152121061	VASANTH KUMAR S	B.TECH I YR	S. V. S.
43.	73152121062	VIPIN S	B.TECH I YR	S. Vipin .
44.	73152121063	YUVANSANDHAR R	B.TECH I YR	R. Yuvansandhar .
45.	2021004	BATSHA. T	B.TECH II YR	T. Batsha .
46.	2021005	BHARATHLP	B.TECH II YR	P. Bharath .
47.	2021006	BHASKARAPRASATH.S.K	B.TECH II YR	S. K. Bhaskaraprath .
48.	2021007	BHUVANESH.G	B.TECH II YR	G. Bhuvanesh .
49.	2021008	DHANUSHYA.K	B.TECH II YR	K. Dhanyushya .
50.	2021009	DIVYA.K	B.TECH II YR	K. Divya .
51.	2021011	FARITHA BANU.M	B.TECH II YR	M. Faritha Banu .
52.	2021012	GIRIJA.V	B.TECH II YR	V. Girija .
53.	2021013	GNANAPRAKASH.J	B.TECH II YR	J. Gnanaprakash .
54.	2021014	GOBIKA.C	B.TECH II YR	C. Gobika .
55.	2021015	GOKUL.R	B.TECH II YR	R. Gokul .
56.	2021016	GOKUL.V	B.TECH II YR	V. Gokul .
57.	2021017	GOPLM	B.TECH II YR	M. G. S. I.

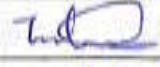
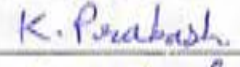
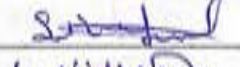
58.	2021018	GOPINATH.N	B.TECH II YR	M. Gopinath
59.	2021019	HARIPRASATH.S	B.TECH II YR	H. Prasad
60.	2021020	HARIPRIYA.G	B.TECH II YR	G. Haripriya
61.	2021021	KALPANA.V	B.TECH II YR	V. Kalpana
62.	2021022	KANISHKA.V	B.TECH II YR	V. Kanishka
63.	2021023	KAVIN.S	B.TECH II YR	S. Kavitha
64.	2021024	KAVIN KUMAR.R	B.TECH II YR	R. Kavin Kumar
65.	2021025	KISHORE.B	B.TECH II YR	B. Kishore
66.	2021026	LALITH KUMAR.R	B.TECH II YR	R. Lalitha
67.	2021027	LOGA MOORTHY.S	B.TECH II YR	S. Loga Moorthy
68.	2021028	MANIBHARATHI.J	B.TECH II YR	J. Manibharathi
69.	2021029	MANIKANDAN.S	B.TECH II YR	S. Manikandan
70.	2021030	MITHRA.S.P	B.TECH II YR	S.P. Mithra
71.	2021031	MOHAMEDFAHEEM.S	B.TECH II YR	S. Mohd Fahem
72.	2021043	SANJAY.J	B.TECH II YR	J. Sanjay
73.	2021044	SANTHOSHA	B.TECH II YR	A. Santhosh
74.	2021045	SATHISHA	B.TECH II YR	S. Sathisha
75.	2021046	SHARUKES.K	B.TECH II YR	K. Sharukesh
76.	2021047	SHARVESH.M	B.TECH II YR	M. Sharvesh
77.	2021048	SHEVAKSRI.P	B.TECH II YR	P. Shevakshi
78.	2021049	SRITHAR.S.V	B.TECH II YR	V. Srithar
79.	2021050	SUGANESH.G	B.TECH II YR	G. Suganesh
80.	2021051	SURRIYAA.P.P	B.TECH II YR	P.P. Surriya
81.	2021052	SUWETHAA.M.K	B.TECH II YR	K. Suwetha
82.	2021053	TAMILZHARASU.M.P	B.TECH II YR	P. Tamilzharasu
83.	2021054	VASANTH.P	B.TECH II YR	P. Vasanth
84.	2021055	VASANTH.V	B.TECH II YR	V. Vasanth
85.	2021056	VASUDEVAN.R	B.TECH II YR	R. Vasudevan
86.	2021057	VIGNESH.S	B.TECH II YR	S. Vignesh
87.	2021058	VIGNESH.C	B.TECH II YR	C. Vignesh
88.	2021059	VIMALAA SRL.V.S	B.TECH II YR	S. Vimala
89.	2021060	YUVASREES	B.TECH II YR	S. Yuvaree
90.	2021501	ESWAR CHANDAR. P	B.TECH II YR	P. Eswar Chandar
91.	2021502	GOWTHAMAN .S	B.TECH II YR	S. Gowthaman

92.	2021503	JEENATH .N	B.TECH II YR	
93.	2021504	PRAKASH .K	B.TECH II YR	
94.	2021505	SIVABALAN. G	B.TECH II YR	
95.	2021506	VIDHYASRI. G	B.TECH II YR	



Course coordinator

T. SATHISH KUMAR



HOD-IT

Dr. G. Singaravel
 Professor & Head
 Department of Information Technology
 K.S.R. College of Engineering (Autonomous)
 Tiruchengode - 637 215
 Tamilkallal (Dt), Tamilnadu, India.



PRINCIPAL,
 K.S.R. COLLEGE OF ENGINEERING
 TIRUCHENGODE - 637 209.



K.S.R COLLEGE OF ENGINEERING (AUTONOMOUS), TIRUCHENGODE – 637215
DEPARTMENT OF INFORMATION TECHNOLOGY

Name of the course : CORPORATE COMMUNICATION SKILL FOR BEGINEERS

Name of the resource person :Kaveen prasanamoorthy and R.Krishna pradeep

Course coordinator: : Dr.G.Singaravel and Mr.T.Sathish kumar

Date : 09/05/2022

Attendance sheet

S.NO	Reg. No.	Name	09/05/22	10/05/22	11/05/22	12/05/22	13/05/22
			AN	AN	AN	AN	AN
1.	73152121002	AJAY SUNDAR S M	S.M. Anj	S. M. Anji	S.M Anj	S.M. Anj	S.M. Anj
2.	73152121003	AKILAN K	K. Akilan	K. Akilan	K. Akilan	K. Akilan	K. Akilan
3.	73152121004	ARJUNAN S	Arjun	Arjun	Arjun	Arjun	Arjun
4.	73152121005	ARSHAD AHAMAD J	Ahamad	Ahamad	Ahamad	Ahamad	Ahamad
5.	73152121006	ARUNA R V	Aruna	Aruna	Aruna	Aruna	Aruna
6.	73152121007	BALAJI S	B. Balaji	B. Balaji	B. Balaji	B. Balaji	B. Balaji
7.	73152121008	BHARATH R [RAVICHANDRAN]	R. Bharath	R. Bharath	R. Bharath	R. Bharath	R. Bharath
8.	73152121009	BHARATH S	Bharath	Bharath	Bharath	Bharath	Bharath
9.	73152121010	BHARATHAN.V	V. Bharath	V. Bharath	V. Bharath	V. Bharath	V. Bharath
10.	73152121011	BHARATHKUMAR S	S. Bharath	S. Bharath	S. Bharath	S. Bharath	S. Bharath
11.	73152121012	BOOMIKA K	Boomika	Boomika	Boomika	Boomika	Boomika
12.	73152121013	BRINDHAR	R. Brindha	R. Brindha	R. Brindha	R. Brindha	R. Brindha
13.	73152121014	DARUNIKA B	B. Darunika	B. Darunika	B. Darunika	B. Darunika	B. Darunika
14.	73152121015	DAYANIDI G V	G.V. Dayanidi	G.V. Dayanidi	G.V. Dayanidi	G.V. Dayanidi	G.V. Dayanidi
15.	73152121016	DEEPAKARAN S	S. Deepak	S. Deepak	S. Deepak	S. Deepak	S. Deepak
16.	73152121017	DEEPTHI R	R. Deepthi	R. Deepthi	R. Deepthi	R. Deepthi	R. Deepthi
17.	73152121018	DEETCHANA V	V. Deetchana	V. Deetchana	V. Deetchana	V. Deetchana	V. Deetchana
18.	73152121019	DEVADHARSHINI M	M. Devadharshini	M. Devadharshini	M. Devadharshini	M. Devadharshini	M. Devadharshini
19.	73152121020	DHANUSH CHANDAR	D. Chandar	D. Chandar	D. Chandar	D. Chandar	D. Chandar
20.	73152121021	DILIP S	S. Dilip	S. Dilip	S. Dilip	S. Dilip	S. Dilip
21.	73152121022	ELIZABETH R	R. Elizabeth	R. Elizabeth	R. Elizabeth	R. Elizabeth	R. Elizabeth
22.	73152121041	NITHISH K	N. Nithish	N. Nithish	N. Nithish	N. Nithish	N. Nithish
23.	73152121042	NITHISH N	N. Nithish	N. Nithish	N. Nithish	N. Nithish	N. Nithish

24.	73152121043	NIVETHA S	Nivetha	Nivetha	S.Nth	S. Nth	S. Nth
25.	73152121044	PRAKASH..K	Prakash	Prakash	Prakash	Prakash	Prakash
26.	73152121045	RAHMAN BASHA S	S.Ram	S.Ram	S.Ram	S.Ram	S.Ram
27.	73152121046	RAMSURYA J	Ramsurya	Ramsurya	Ramsurya	Ramsurya	Ramsurya
28.	73152121047	SAKTHIVEL S	S.Surya	S.Surya	S.Surya	S.Surya	S.Surya
29.	73152121048	SANJAY B	B.Sanjay	B.Sanjay	B.Sanjay	B.Sanjay	B.Sanjay
30.	73152121049	SANTHOSH KUMAR S	S.Santh	S.Santh	S.Santh	S.Santh	S.Santh
31.	73152121050	SARAN M S	M.S.Saran	M.S.Saran	M.S.Saran	M.S.Saran	M.S.Saran
32.	73152121051	SASIDHARAN.E	E.Sasid	E.Sasid	E.Sasid	E.Sasid	E.Sasid
33.	73152121052	SHREE HAREETH S K	S.K.Hareeth	S.K.Hareeth	S.K.Hareeth	S.K.Hareeth	S.K.Hareeth
34.	73152121053	SIDHANANTH R	R.Sidhan	R.Sidhan	R.Sidhan	R.Sidhan	R.Sidhan
35.	73152121054	SIVABALAN K	K.Sivabalan	K.Sivabalan	K.Sivabalan	K.Sivabalan	K.Sivabalan
36.	73152121055	SIVADHARANI S	S.Sivadh	S.Sivadh	S.Sivadh	S.Sivadh	S.Sivadh
37.	73152121056	SRIDHAR S	S.Sridhar	S.Sridhar	S.Sridhar	S.Sridhar	S.Sridhar
38.	73152121057	SUBASH B	B.Subash	B.Subash	B.Subash	B.Subash	B.Subash
39.	73152121058	SUBASH .S	S.Subash	S.Subash	S.Subash	S.Subash	S.Subash
40.	73152121059	THASVINTHRAGUL S	S.Thasvin	S.Thasvin	S.Thasvin	S.Thasvin	S.Thasvin
41.	73152121060	THIRUMURUGAN T	T.Thirum	T.Thirum	T.Thirum	T.Thirum	T.Thirum
42.	73152121061	VASANTH KUMAR S	S.Vasanth	S.Vasanth	S.Vasanth	S.Vasanth	S.Vasanth
43.	73152121062	VIPIN S	S.Vipin	S.Vipin	S.Vipin	S.Vipin	S.Vipin
44.	73152121063	YUVANSANDHAR R	R.Yuvan	R.Yuvan	R.Yuvan	R.Yuvan	R.Yuvan
45.	2021004	BATSHA. T	T.Batsha	T.Batsha	T.Batsha	T.Batsha	T.Batsha
46.	2021005	BHARATH.P	P.Bharath	P.Bharath	P.Bharath	P.Bharath	P.Bharath
47.	2021006	BHASKARAPRASATH	S.Bhaskar	S.Bhaskar	S.Bhaskar	S.Bhaskar	S.Bhaskar
48.	2021007	BHUVANESH.G	G.Bhuvan	G.Bhuvan	G.Bhuvan	G.Bhuvan	G.Bhuvan
49.	2021008	DHANUSHYA.K	K.Dhanush	K.Dhanush	K.Dhanush	K.Dhanush	K.Dhanush
50.	2021009	DIVYA.K	K.Divya	K.Divya	K.Divya	K.Divya	K.Divya
51.	2021011	FARITHA BANU.M	M.Faritha	M.Faritha	M.Faritha	M.Faritha	M.Faritha
52.	2021012	GIRIJA.V	V.Girija	V.Girija	V.Girija	V.Girija	V.Girija
53.	2021013	GNANAPRAKASH.J	J.Gnanapr	J.Gnanapr	J.Gnanapr	J.Gnanapr	J.Gnanapr
54.	2021014	GOBIKA.C	C.Gobika	C.Gobika	C.Gobika	C.Gobika	C.Gobika
55.	2021015	GOKUL.R	R.Gokul	R.Gokul	R.Gokul	R.Gokul	R.Gokul
56.	2021016	GOKUL.V	V.Gokul	V.Gokul	V.Gokul	V.Gokul	V.Gokul
57.	2021017	GOPLM	M.Gopi	M.Gopi	M.Gopi	M.Gopi	M.Gopi
58.	2021018	GOPINATH.N	N.Gopin	N.Gopin	N.Gopin	N.Gopin	N.Gopin

59.	2021019	HARIPRASATH.S						
60.	2021020	HARIPRIYA.G	G.Naraj	G.Naraj	G.Naraj	G.Naraj	G.Naraj	G.Naraj
61.	2021021	KALPANA.V	v.Kalpana	v.Kalpana	v.Kalpana	v.Kalpana	v.Kalpana	v.Kalpana
62.	2021022	KANISHKA.V	v.Banika	v.Banika	v.Banika	v.Banika	v.Banika	v.Banika
63.	2021023	KAVIN.S	S.S.	S.S.	S.S.	S.S.	S.S.	S.S.
64.	2021024	KAVIN KUMAR.R	R.Kavin Kumar	R.Kavin Kumar	R.Kavin Kumar	R.Kavin Kumar	R.Kavin Kumar	R.Kavin Kumar
65.	2021025	KISHORE.B	B.Kishore	B.Kishore	B.Kishore	B.Kishore	B.Kishore	B.Kishore
66.	2021026	LALITH KUMAR.R	R.Lalith	R.Lalith	R.Lalith	R.Lalith	R.Lalith	R.Lalith
67.	2021027	LOGA MOORTHY.S	S.Mitha	S.Mitha	S.Mitha	S.Mitha	S.Mitha	S.Mitha
68.	2021028	MANIBHARATHI.J	J.Mani	J.Mani	J.Mani	J.Mani	J.Mani	J.Mani
69.	2021029	MANIKANDAN.S	S.Manikandan	S.Manikandan	S.Manikandan	S.Manikandan	S.Manikandan	S.Manikandan
70.	2021030	MITHRA.S.P	P.Mithra	P.Mithra	P.Mithra	P.Mithra	P.Mithra	P.Mithra
71.	2021031	MOHAMEDFAHEEM.S	S.Mohamed	S.Mohamed	S.Mohamed	S.Mohamed	S.Mohamed	S.Mohamed
72.	2021043	SANJAY.J	J.Sanjay	J.Sanjay	J.Sanjay	J.Sanjay	J.Sanjay	J.Sanjay
73.	2021044	SANTHOSHA	A.Santhosh	A.Santhosh	A.Santhosh	A.Santhosh	A.Santhosh	A.Santhosh
74.	2021045	SATHISHA.	A.Sathish	A.Sathish	A.Sathish	A.Sathish	A.Sathish	A.Sathish
75.	2021046	SHARUKES.K	K.Sharukesh	K.Sharukesh	K.Sharukesh	K.Sharukesh	K.Sharukesh	K.Sharukesh
76.	2021047	SHARVESH.M	M.Sharvesh	M.Sharvesh	M.Sharvesh	M.Sharvesh	M.Sharvesh	M.Sharvesh
77.	2021048	SHEVAKSRI.P	P.Shevaksri	P.Shevaksri	P.Shevaksri	P.Shevaksri	P.Shevaksri	P.Shevaksri
78.	2021049	SRITHAR.S.V	S.V.Srithar	S.V.Srithar	S.V.Srithar	S.V.Srithar	S.V.Srithar	S.V.Srithar
79.	2021050	SUGANESH.G	G.Suganesh	G.Suganesh	G.Suganesh	G.Suganesh	G.Suganesh	G.Suganesh
80.	2021051	SURRIYAA.P.P	P.P.Surriya	P.P.Surriya	P.P.Surriya	P.P.Surriya	P.P.Surriya	P.P.Surriya
81.	2021052	SUWETHA.A.M.K	M.K.Suwetha	M.K.Suwetha	M.K.Suwetha	M.K.Suwetha	M.K.Suwetha	M.K.Suwetha
82.	2021053	TAMILZHARASU.M.P	P.M.Tamil	P.M.Tamil	P.M.Tamil	P.M.Tamil	P.M.Tamil	P.M.Tamil
83.	2021054	VASANTH.P	P.Vasanth	P.Vasanth	P.Vasanth	P.Vasanth	P.Vasanth	P.Vasanth
84.	2021055	VASANTH.V	V.V.Vasanth	V.V.Vasanth	V.V.Vasanth	V.V.Vasanth	V.V.Vasanth	V.V.Vasanth
85.	2021056	VASUDEVAN.R	R.Vasudevan	R.Vasudevan	R.Vasudevan	R.Vasudevan	R.Vasudevan	R.Vasudevan
86.	2021057	VIGNESH.S	S.Vignesh	S.Vignesh	S.Vignesh	S.Vignesh	S.Vignesh	S.Vignesh
87.	2021058	VIGNESH.C	C.Vignesh	C.Vignesh	C.Vignesh	C.Vignesh	C.Vignesh	C.Vignesh
88.	2021059	VIMALAA SRI.V.S	S.V.Vimala	S.V.Vimala	S.V.Vimala	S.V.Vimala	S.V.Vimala	S.V.Vimala
89.	2021060	YUVASREE.S	S.Yuvaree	S.Yuvaree	S.Yuvaree	S.Yuvaree	S.Yuvaree	S.Yuvaree
90.	2021501	ESWAR CHANDAR. P	P.Chandar	P.Chandar	P.Chandar	P.Chandar	P.Chandar	P.Chandar
91.	2021502	GOWTHAMAN .S	S.Gowthaman	S.Gowthaman	S.Gowthaman	S.Gowthaman	S.Gowthaman	S.Gowthaman
92.	2021503	JEENATH .N	N.Jeenath	N.Jeenath	N.Jeenath	N.Jeenath	N.Jeenath	N.Jeenath
93.	2021504	PRAKASH .K	K.Prakash	K.Prakash	K.Prakash	K.Prakash	K.Prakash	K.Prakash

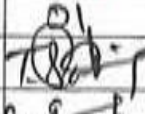
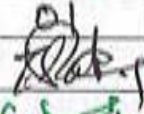
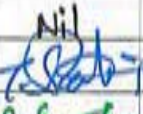
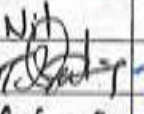
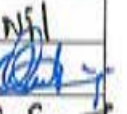
94.	2021505	SIVABALAN. G	A	A	Sivabal	sivabal	Sivabal
95.	2021506	VIDHYASRI. G	G.V. Vidya	G.V. Vidya	G.V. Vidya	G.V. Vidya	G.V. Vidya
Total no. of Students			95	95	95	95	95
Present			94	94	95	95	95
Absent			01	01	Nil	Nil	Nil
Coordinator Signature							
HoD / IT			G. Singaravel 9/5/22	G. Singaravel 10/5/22	G. Singaravel 11/5/22	G. Singaravel 12/5/22	G. Singaravel 13/5/22

G. Singaravel
13/5/22
HoD-IT

Dr. G. Singaravel
Professor & Head
Department of Information Technology
K.S.R. College of Engineering (Autonomous)
Tiruchengode - 637 215
Namakkal (Dt), Tamilnadu, India

PRINCIPAL,
K.S.R. COLLEGE OF ENGINEERING,
TIRUCHENGODE 637 209.



K.S.R COLLEGE OF ENGINEERING (AUTONOMOUS), TIRUCHENGODE – 637215

DEPARTMENT OF INFORMATION TECHNOLOGY

A VALUE ADDED COURSE ON “Corporate Communication Skill for Engineers”

Date: 18.05.2022

GRADE SHEET

S. No.	Register. No	Name of the Student	Year	Grade	Signature
1.	73152121002	AJAY SUNDAR S M	B.TECH I YR	A	A.M. And
2.	73152121003	AKILAN K	B.TECH I YR	B	K. Akilan
3.	73152121004	ARJUNAN S	B.TECH I YR	B	Arjun
4.	73152121005	ARSHAD AHAMAD J	B.TECH I YR	C	Ahamad
5.	73152121006	ARUNA R V	B.TECH I YR	A	Aruna
6.	73152121007	BALAJI S	B.TECH I YR	A	B. Balaji
7.	73152121008	BHARATH R [RAVICHANDRAN]	B.TECH I YR	A	R. Bharath
8.	73152121009	BHARATH S	B.TECH I YR	A	Bharath
9.	73152121010	BHARATHAN.V	B.TECH I YR	C	V. Bharath
10.	73152121011	BHARATHKUMAR S	B.TECH I YR	C	S. Bharath
11.	73152121012	BOOMIKA K	B.TECH I YR	B	K. Boomika
12.	73152121013	BRINDHA R	B.TECH I YR	C	Brindha
13.	73152121014	DARUNIKA B	B.TECH I YR	A	B. Darunika
14.	73152121015	DAYANIDI G V	B.TECH I YR	C	G.V. Dayanidi
15.	73152121016	DEEPAKARAN S	B.TECH I YR	B	S. Deepakaran
16.	73152121017	DEEPTHIR	B.TECH I YR	A	R. Deepthi
17.	73152121018	DEETCHANA V	B.TECH I YR	A	V. Deetchana
18.	73152121019	DEVADHARSHINI M	B.TECH I YR	C	M. Devadharshini
19.	73152121020	DHANUSH CHANDAR N A	B.TECH I YR	C	S. Dhana
20.	73152121021	DILIP S	B.TECH I YR	B	S. Dilip

21.	73152121022	ELIZABETH R	B.TECH I YR	A	R.Elizabeth
22.	73152121041	NITHISH K	B.TECH I YR	A	AD2
23.	73152121042	NITHISH N	B.TECH I YR	A	N. NITHISH
24.	73152121043	NIVETHA S	B.TECH I YR	B	@-Neh
25.	73152121044	PRAKASHIL.K	B.TECH I YR	B	Prakash.k
26.	73152121045	RAHMAN BASHA S	B.TECH I YR	C	S.P.ash
27.	73152121046	RAMSURYA J	B.TECH I YR	C	R
28.	73152121047	SAKTHIVEL S	B.TECH I YR	A	S. Sakthivel
29.	73152121048	SANJAY B	B.TECH I YR	C	B. sajj
30.	73152121049	SANTHOSH KUMAR S	B.TECH I YR	A	S. Santosh
31.	73152121050	SARAN M S	B.TECH I YR	C	MS. Saran
32.	73152121051	SASIDHARAN.E	B.TECH I YR	B	E. Sathya
33.	73152121052	SHREE HAREETH S K	B.TECH I YR	A	S.H. Sree
34.	73152121053	SIDHANANTH R	B.TECH I YR	C	Sidhananth.R
35.	73152121054	SIVABALAN K	B.TECH I YR	A	K. Sivabalan
36.	73152121055	SIVADHARANI S	B.TECH I YR	B	S. Sivas
37.	73152121056	SRIDHAR S	B.TECH I YR	B	S. Sridhar
38.	73152121057	SUBASH B	B.TECH I YR	C	B. Subash
39.	73152121058	SUBASH .S	B.TECH I YR	C	S. Subash
40.	73152121059	THASVINTHRAGUL S	B.TECH I YR	A	AJ
41.	73152121060	THIRUMURUGANT	B.TECH I YR	A	Thir
42.	73152121061	VASANTH KUMAR S	B.TECH I YR	A	S. Ven
43.	73152121062	VIPIN S	B.TECH I YR	B	S. Vipin
44.	73152121063	YUVANSANDHAR R	B.TECH I YR	B	R. Yuvarthender
45.	2021004	BATSHA. T	B.TECH II YR	B	T. Bats
46.	2021005	BHARATHILP	B.TECH II YR	C	Bharath
47.	2021006	BHASKARAPRASATHI.S.K	B.TECH II YR	C	Bhaskarprath.k.

48.	2021007	BHUVANESH.G	B.TECH II YR	C	B. G.
49.	2021008	DHANUSHYA.K	B.TECH II YR	A	Dhanushya
50.	2021009	DIVYA.K	B.TECH II YR	A	Divya
51.	2021011	FARITHA BANU.M	B.TECH II YR	B	Faritha Banu
52.	2021012	GIRIJA.V	B.TECH II YR	B	Giri
53.	2021013	GNANAPRAKASH.J	B.TECH II YR	A	Gnanaprakash
54.	2021014	GOBIKA.C	B.TECH II YR	A	Gobika
55.	2021015	GOKUL.R	B.TECH II YR	B	Gokul
56.	2021016	GOKUL.V	B.TECH II YR	B	Gokul
57.	2021017	GOPLM	B.TECH II YR	C	Gop
58.	2021018	GOPINATH.N	B.TECH II YR	C	Gopinath
59.	2021019	HARIPRASATH.S	B.TECH II YR	A	Hariprasath
60.	2021020	HARIPRIYA.G	B.TECH II YR	A	Haripriya
61.	2021021	KALPANA.V	B.TECH II YR	C	Kalp
62.	2021022	KANISHKA.V	B.TECH II YR	C	Kanishka
63.	2021023	KAVIN.S	B.TECH II YR	B	Kavin
64.	2021024	KAVIN KUMAR.R	B.TECH II YR	B	Kavin Kumar
65.	2021025	KISHORE.B	B.TECH II YR	A	Kishore
66.	2021026	LALITH KUMAR.R	B.TECH II YR	A	Lalith
67.	2021027	LOGA MOORTHY.S	B.TECH II YR	B	Loga
68.	2021028	MANIBHARATHI.J	B.TECH II YR	B	Mani
69.	2021029	MANIKANDAN.S	B.TECH II YR	A	Mani
70.	2021030	MITHRA.S.P	B.TECH II YR	A	Mithra
71.	2021031	MOHAMEDFAHEEM.S	B.TECH II YR	A	Mohamed
72.	2021043	SANJAY.J	B.TECH II YR	A	Sanjay
73.	2021044	SANTHOSHA	B.TECH II YR	A	Santhosha
74.	2021045	SATHISH.A	B.TECH II YR	C	Sathish

75.	2021046	SHARUKES.K	B.TECH II YR	A	K. Sharukesh
76.	2021047	SHARVESH.M	B.TECH II YR	A	Sharvesh
77.	2021048	SHEVAKSRLP	B.TECH II YR	A	Shevak Sri P
78.	2021049	SRITHAR.S.V	B.TECH II YR	A	S.V. Srithar
79.	2021050	SUGANESH.G	B.TECH II YR	C	G. Suganesh
80.	2021051	SURRIYAA.P.P	B.TECH II YR	C	P.P. Surriya
81.	2021052	SUWETHAA.M.K	B.TECH II YR	B	M.K. Suwetha
82.	2021053	TAMILZHARASU.M.P	B.TECH II YR	B	Tamilharasu M.P
83.	2021054	VASANTH.P	B.TECH II YR	A	V. Ananth
84.	2021055	VASANTH.V	B.TECH II YR	C	V. Ananth
85.	2021056	VASUDEVAN.R	B.TECH II YR	B	R. Vasudevan
86.	2021057	VIGNESH.S	B.TECH II YR	C	S. Vignesh
87.	2021058	VIGNESH.C	B.TECH II YR	A	Vignesh C
88.	2021059	VIMALAA SRI.V.S	B.TECH II YR	A	V.S. Vimala
89.	2021060	YUVASREES	B.TECH II YR	A	S. Yuvasrees
90.	2021501	ESWAR CHANDAR. P	B.TECH II YR	A	P. Chandar Eswar
91.	2021502	GOWTHAMAN .S	B.TECH II YR	A	S. Gowthaman
92.	2021503	JEENATH .N	B.TECH II YR	A	N. Jeenath
93.	2021504	PRAKASH .KB	B.TECH II YR	B	B. Prakash
94.	2021505	SIVABALAN. G	B.TECH II YR	B	G. Sivabalan
95.	2021506	VIDHYASRI. G	B.TECH II YR	C	G. Vidhyasri

91-100 O (Outstanding); 81-90 A+ (Excellent);

71-80 A (Very Good); 65-70 B+ (Good) ;60-65 B (Average);RA>60

 COURSE CO-ORDINATOR
 T.SATHISHKOMAR



 PRINCIPAL,
 K.S.R. COLLEGE OF ENGINEERING
 TIRUCHENGODE - 637 909



HoD - IT
 Dr. G. Singaravel
 Professor & Head
 Department of Information Technology
 K.S.R. College of Engineering (Autonomous)
 Tiruchengode - 637 215
 Namakkal (Dt), Tamilnadu, India.

K.S.R COLLEGE OF ENGINEERING(Autonomous), TIRUCHENGODE – 637 215
DEPARTMENT OF INFORMATION TECHNOLOGY
FEED BACK FORM

Kindly spare a few minutes and fill up the form to help us to improve our efforts in future.

Name of the Programme : *Value added course on "Corporate Communication Skill for Engineers" 09.05.2022 - 13.05.2022, F – Block, Class Room F-104, KSRCE Campus.*

Name of the Student : *G. Poovaiyan*

Register No. : *2021036*

Kindly evaluate in the following scale by ticking on the relevant grade.

1. Very Good 2. Good 3. Satisfactory 4. Unsatisfactory

1. Did you find the Event useful?	1	2	3	<input checked="" type="checkbox"/> 4
2. Did it cover what you were expecting?	1	2	<input checked="" type="checkbox"/> 3	4
3. The content was helpful.	1	2	3	<input checked="" type="checkbox"/> 4
4. The level of the event was appropriate.	1	2	3	<input checked="" type="checkbox"/> 4
5. The format was enjoyable.	1	2	3	<input checked="" type="checkbox"/> 4
6. Did you receive all the information?	1	2	<input checked="" type="checkbox"/> 3	4
7. The speaker had a good understanding of the topics.	1	2	<input checked="" type="checkbox"/> 3	4
8. Whether the event worth your time?	1	2	3	<input checked="" type="checkbox"/> 4
9. The length of the event was appropriate.	1	2	3	<input checked="" type="checkbox"/> 4
10. Is the facilities were adequate and comfortable?	1	2	3	<input checked="" type="checkbox"/> 4



Date: *13.05.2022*

G. S. Singara
Dr. G. Singara
 Professor & Head
 Department of Information Technol.
 K.S.R. College of Engineering (Autonomous),
 Tiruchengode - 637 215
 Namakkal (Dt), Tamilnadu, India.

[Signature]
 PRINCIPAL,
 K.S.R. COLLEGE OF ENGINEERING
 TIRUCHENGODE 637 209.

G. Poovaiyan
 Students Signature

K.S.R COLLEGE OF ENGINEERING(Autonomous), TIRUCHENGODE – 637 215
DEPARTMENT OF INFORMATION TECHNOLOGY
FEED BACK FORM

Kindly spare a few minutes and fill up the form to help us to improve our efforts in future.

Name of the Programme : *Value added course on "Corporate Communication Skill for Engineers"09.05.2022 - 13.05.2022, F – Block, Class Room F-104, KSRCE Campus.*

Name of the Student : *Santhosh. A*

Register No. : *2021044*

Kindly evaluate in the following scale by ticking on the relevant grade.

1. Very Good 2. Good 3. Satisfactory 4. Unsatisfactory

- | | | | | |
|--|---|---|---|---|
| 1. Did you find the Event useful? | 1 | 2 | 3 | 4 |
| 2. Did it cover what you were expecting? | 1 | 2 | 3 | 4 |
| 3. The content was helpful. | 1 | 2 | 3 | 4 |
| 4. The level of the event was appropriate. | 1 | 2 | 3 | 4 |
| 5. The format was enjoyable. | 1 | 2 | 3 | 4 |
| 6. Did you receive all the information? | 1 | 2 | 3 | 4 |
| 7. The speaker had a good understanding of the topics. | 1 | 2 | 3 | 4 |
| 8. Whether the event worth your time? | 1 | 2 | 3 | 4 |
| 9. The length of the event was appropriate. | 1 | 2 | 3 | 4 |
| 10. Is the facilities were adequate and comfortable? | 1 | 2 | 3 | 4 |



[Signature]
 PRINCIPAL,
 K.S.R. COLLEGE OF ENGINEERING,
 TIRUCHENGODE - 637 203.

[Signature]
 Students Signature

Date: *13.05.2022*

[Signature]
13/5/22
 Dr. G. Singaravel
 Professor & Head
 Department of Information Technology,
 College of Engineering (Autonomous),
 Tiruchengode - 637 215

**K.S.R. COLLEGE OF ENGINEERING (Autonomous)
TIRUCHENGODE, TAMILNADU - 637 215**



**DEPARTMENT OF INFORMATION TECHNOLOGY
VALUE - ADDED COURSE**

Software Manual Testing

18.07.2022 - 22.07.2022

in association with

**DEPARTMENT OF INFORMATION TECHNOLOGY,
K. S. R. COLLEGE OF ENGINEERING
(Autonomous)
TIRUCHENGODE - 637 215.**

**Dr. K.BALAMURUGAN
ASSOCIATE PROFESSOR**

&

**Mr. S.GOWTHAM
ASSISTANT PROFESSOR**

**DEPARTMENT OF INFORMATION TECHNOLOGY
K. S. R. COLLEGE OF ENGINEERING
(Autonomous)**

**TIRUCHENGODE - 637 215
NAMAKKAL DISTRICT, TAMILNADU-INDIA.**

PRINCIPAL
K. S. R. COLLEGE OF ENGINEERING,
TIRUCHENGODE - 637 209

JULY 2022

K. S. R. COLLEGE OF ENGINEERING (Autonomous)
TIRUCHENGODE – 637 215

Department of Information Technology

Check List for Event / Programme Organized

1. Name of Event/ Programme : Seminar
 Workshop
 Value Added Course
 Guest lecturer
 Training and Placement Oriented Programme
 Industries Series/ Talk Lecturer
 Students Skill Development (SSD)
 Symposium (National / International)
 Conference (National / International)
 Alumni Lecture Series
 Alumni Meet
 Parent's Meet

2. Name of the Faculty Coordinator/ Chairperson/ Convener : K. BALAMURUGAN
S. GOWTHAM

3. Name of Event / Program / Title : SOFTWARE MANUAL TESTING

4. Mode of conducting : Physical Online

5. Approval Type : Self Organization
 AICTE / DST / SERB
 Anna University
 Professional Bodies
 Government Funding

- Alumni Sporesed
 Any Other
6. Approval Letter : Yes No
7. Chair / Principal Approval : Approval Not Approval
(Attach Approval Letter)
8. Brochure : Yes No
9. Poster / flux : Yes No
10. Invitation : Yes No
11. Resource person Chief guest/
Session Chair/ Keynote Speaker : Yes No
Letter Communication
12. Sample PPT / Document / PDF : Yes No
13. Registration & List of Participants: Yes No
14. Feedbacks : Yes No
15. Photos : Yes No
16. Bill Settlement Copies : Yes No
17. Utilization Certification : Yes No
18. Report : Yes No
19. Sample Certificate : Yes No

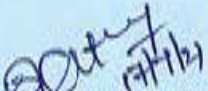
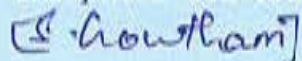

 Faculty Coordinator
 Chairperson/ Convener



 Head of the Department
Dr. G. Singaravel
 Professor & Head
 Department of Information Technology
 K.S.R. College of Engineering (Autonomous)
 Tiruchengode - 637 215
 Tamil Nadu, India.

 Principal
PRINCIPAL
K.S.R. COLLEGE OF ENGINEERING
 K.S.R. KALVI NAGAR,
 TIRUCHENGODE-637 215

K.S.R. COLLEGE OF ENGINEERING (Autonomous): TIRUCHENGODE - 637 215

Date: 11-07-2022

Time: 11.30 a.m.

CIRCULAR

Classification	ROUTINE ✓	IMMEDIATE
ORIGINATOR:HOD- IT		CIRCULATED TO: B.Tech. IT- III Year

Sub: VALUE ADDED COURSE 2021-2022 - Reg.

There will be a Valued Added Course for B.Tech I.T III-Year for the academic year 2021-2022 on topic of "SOFTWARE MANUAL TESTING " from 18.07.2022 (Monday) to 22.07.2022 (Friday), Time 9.30 am-5.30pm at F-Block, First Floor, R2S Lab . All the Willing students should register their name to Course Coordinator Mr.S.Gowtham, Assistant Professor/IT. The resource person and other details are given below.

Resource Person:

1. Dr.G.Singaravel- Professor and Head
 - Mr.G.Nagarajan- Assistant professor-IT
 - Mr.T.Saransujai- Assistant professor-IT
- Department of Information Technology,
K.S.R College of Engineering,
Tiruchengode- 637215.

Course Coordinator:

1. Dr. K.Balamurugan
Associate Professor-IT
2. Mr.S.Gowtham
Assistant professor-IT

Note : Maximum of Register Capacity: 65 Students

Instructions to the students through Course Coordinator

1. Dress Code (Self Grooming, Formal wear with shoes)
2. Discipline and attendance is compulsory to attend the program.
3. Punctuality

If any student not follows the above he/she may not be allowed to proceed further.



PRINCIPAL
K.S.R. COLLEGE OF ENGINEERING
KALVI NAGAR,
TIRUCHENGODE-637 215

HoD / IT
Dr. G. Singaravelu
Professor & Head
Department of Information Technology
K.S.R. College of Engineering (Autonomous)
Tiruchengode - 637 215
Namakkal (Dt), Tamilnadu, India

EVIDENCE OF COMPLETION

Number of persons not received / seen: - _____

Signature of Originator with Date and time.

K.S.R. COLLEGE OF ENGINEERING (Autonomous)

(An Autonomous Institution, approved by AICTE, Accredited by NAAC with A grade
& Affiliated to Anna University)

**K.S.R. Kalvi Nagar, Tiruchengode – 637 215,
Namakkal District, Tamil Nadu**

Phone: 04288-274213

Fax: 04288-274757

E - mail: principal@ksrce.ac.in

Department of Information Technology

Phone :9943455245(HoD)

e - mail:ksrceitdept@gmail.com

Date: 12.07.2022

Submitted to Principal:

Sub.: Permission for conducting Value Added Course on “Software Manual Testing”- Reg.

Respected sir,

Our department has been planned to conduct Third Year B.Tech I.T students on the topic of “Software Manual Testing” from 18.07.2022(Monday) to 22.07.2022(Friday), Time 9.30a.m-5.30p.m at F-Block, First Floor, R2S Lab, KSRCE. Hence, We request to give me permission for the same.

Thanking You,

1.Dr.G.Singaravel- Professor and Head
2.Mr.G.Nagarajan- Assistant professor-IT
3.Mr.T.Saransujai- Assistant professor-IT
Department of Information Technology,
K.S.R College of Engineering,
Tiruchengode- 637215

1.Dr..Balamurugan
Associate Professor-IT
2.Mr.S.Gowtham
Assistant professor-IT

Copy to:
Association file & HoD file

Course Co-ordinator

[Signature]
[S. Gowtham PP (IT)]



Signature of HOD

[Signature]
Dr. G. Singaravel
Professor & Head
Department of Information Technoic
K.S.R. College of Engineering (Autonomo..
Tiruchengode - 637 215
Namakkal (Dt), Tamilnadu, India.

Principal

PRINCIPAL
K.S.R. COLLEGE OF ENGINEERING
K.S.R. KALVI NAGAR,
TIRUCHENGODE-637 215

CURRICULAM VITAE

Dr.G.SINGARAVEL, BE., ME., Ph.D., MISTE.,MCSI.,



Professor & Head

Department of Information Technology
K.S.R. College of Engineering (Autonomous)
Tiruchengode- 637 215

Namakkal District, Tamilnadu, India.

Mobile: +91 - 9943455245

Res. Ph: 04256 230194

E-mail: singaravelg@gmail.com

hodit@ksrce.ac.in

URL: Singaravel.in

Dr. G. SINGARAVEL received the D.C.T degree in Computer Technology in 1995 from Kongu Polytechnic College and the Undergraduate degree B.E. (Electronics and communication and Engineering) in 1999 in Kongu Engineering College from the Bharathiyar University. He completed his master degree M.E. (Computer Science and Engineering) in 2002 at Arulmigu Kalasalingam College of Engineering from Madurai Kamaraj University. He received his Ph.D. degree in the area of Information and Communication from Anna University, Chennai in 2010. He has 22 years of teaching experience. He is a Professor and the Head of the Department of Information Technology, K.S.R College of Engineering (Autonomous), Tiruchengode. He is recognizing as a Supervisor for Ph. D Programme and M.Tech (By Research) in Computer Science and Engineering at Anna University, Chennai. He is trained certificate holder of 'High impact Teaching Skills' through Wipro Mission 10X and Trained Evaluator & Resource Person of NBA (National Board of Accreditation) by AICTE, New Delhi. Chief Advisor for Technology Updates and Monitoring Overseas at client project at Accrete Software services & Resource, Chennai. He is in the editorial board member of 6 International/National Journals. He has published 60 papers in international, national journals and conference proceedings and having Google Scholar citations and h-index. He has guided 30 Master Degree projects. He is Guiding 17 PhD research scholars in various domains and 8 Research scholar were Completed.His areas of research include Software Engineering, Agile Project Management, Green &Cloud Computing, Big Data Analytics, etc.,

I am happy to share that 08 Ph.D. scholars have completed under my supervision. In my past, I have headed the role for supporting Information Technology Department for getting NBA in 2008, 2012.

The highlights of my contribution include – Member of Board of members for KSR College of Engineering for NAAC. I had the opportunity to learn, understand and contribute in accreditation process as a steering committee head, I am happy to inform that our institute has got accredited with status 'A' during NAAC visit -2017. Currently Chairman for Computer Society of India(CSI), Salem Chapter.

As a part of the education community, I am interested to share my learnt experience to my academic contacts.

Academics Experience

Teaching Experience : 23 Years

After Ph.D : 10 Years, 7 Months

Achievement			
Teaching Experience	: 22 Years	Session Chaired in Conferences	: 10
Patent Granted & Published	: 04	National Conference Organized	: 02
Book published	: 03	International Editorial Board	: 19
Indexed Journal	: 20	International Conference Organized	: 03
Ph.D. Research Completed	: 08	National Workshops/Seminars Organized	: 22
Research and Funding Agency (R&D)		International Journal Publications	: 50
AICTE (RPS/FDP/STP)	: 03	National Journal Publications	: 02
SERB-DST	: 01	International Conferences	: 18
CSRI	: 01	National Conferences	: 12
CSI	: 08	National/International Workshop attended	: 30
Anna University	: 02	National/International SDP/FDP attended	: 09
DIT	: 01	Project guided for Post Graduate level	: 10
Consultancy Projects	: 03	Project guided for Under Graduate level	: 25
Sessions/Symposium Organized	: 25	Mini Project guided for Under Graduate level	: 10
President of Society	: 01	Awards	: 03
Membership in Professional Bodies	: 04		
Faculty Development Program Organized	: 10		

Research Scholar Details

Number of PhD Scholars					
SRL. NO	Status	Research Area	Regno	Name of the Scholar	University
1	Completed	Data Mining and Data Warehousing	11260631045	Prakash M	Anna University
2	Completed	Computer Network	10960121034	Dhanasekaran R	Anna University
3	Thesis Submitted	Image processing	11260531049	Paneer Selvam R	Anna University
4	Confirmation Completed	Data Mining	17134691241	Tamilarasu P	Anna University
5	Confirmation Completed	Big Data	17134691345	Arunkumar K.G	Anna University
6	Completed	Software Engineering	71130631021	Karuppusamy S	Anna University
7	Completed	Software Engineering	71130631047	Sakthivel M	Anna University
8	Completed	Wireless Sensor Network	71160531006	Eswaramcoorthi R	Anna University
9	Completed	Wireless Sensor	71160631045	Sachidhanandam P	Anna University

		Network			
10	Confirmation Completed	Cloud Computing	D14CS019	Rajesh M	Bharth University
11	Confirmation Completed	Cloud Computing	D14CS011	Senthil J	Bharth University
12.	Thesis Submitted	Image Processing	17234697430	Kanimozhi N	Anna University
13.	Thesis Submitted	Data Mining	1423469728	Kavitha N.S	Anna University
14.	Completed	Virtualization	1414439913	Gokuldhev M	Anna University
15.	Completed	Geo-Computing	16134697396	Nithyanantham S	Anna University
16.	Confirmation Completed	Image Processing	18244697159	Revathi M	Anna University
17.	Course Work	Artificial Intelligent	21194691511	Praveen Kumar K	Anna University
18.	Course Work	Big Data Analytic	21144697188	Kaveen P	Anna University
19.	Course Work	Computer Network	21194697406	P.N.V.Sivakumar	Anna University
20.	Course Work	Computer Network	21254697668	Yarlagadda Sirisha	Anna University

Professional Details

- **Since July 1, 2011: Professor and Head** in Department of Information Technology, K.S.R. College of Engineering (Autonomous), Tiruchengode, Affiliated to Anna University, Chennai.
- **From July 2003 - June 2011: Professor and Head** of the Department of Computer Science and Engineering, K.S.R. College of Engineering, Tiruchengode, Affiliated to Anna University of Technology, Coimbatore.
- **From Jan 2002 - May 2003: Lecturer** in the department of Computer Science and Engineering, Dr. M.G.R. Engineering College, Chennai, Affiliated to Anna University, Chennai.
- **From Jun 1999 - Jan 2002: Lecturer** in the department of Computer Science and Engineering, Jaya Engineering College, Chennai, Affiliated to Anna University, Chennai.

Pedagogic Details			
Degree qualification	Institute/University	Percentage	Year of passing
Ph.D. (Information and Communication)	Anna University, Chennai	Highly Recommended	Nov 2010
M.E. (Computer Science and Engineering.)	Arulmigu Kalasalingam College of Engineering, Krishnankovil, Madurai (Dt) Tamilnadu, India. Madurai Kamaraj University, Madurai	82%	April 2002
B.E (Electronics and Communication Engineering)	Kongu Engineering College, Perundurai, Erode (Dt) TamiNadu, India. Bharathiyar University, Coimbatore	67%	May 1999
D.C.T (Computer technology)	Kongu Polytechnic, Perundurai, Erode (Dt), Tamilnadu, India Direct of Technical Education, Chennai	74%	April 1995

Computer Proficiency	
Technology	Resources
Operating system	Windows NT Server, Windows 7/XP /95/98/2000, DOS
Languages	C, C++, JAVA, Dot Net, Python
Scripting Languages	ASP, XML, HTML, JAVA SCRIPT
Network Technology	TCP/IP, LAN, WAN, Distributed System, CORBA, COM & DCOM, INTERNET
Front End Tool	VB 6.0
Testing Tool	Win Runner, Load Runner, Risk Rader, Weka
Packages	Microsoft Office 2007/2010

Academic Specializations	
Research Specialization	Subject specialization
<ul style="list-style-type: none"> • Software Engineering • Agile Methodologies • Software Testing • Information Security • Agile Methodologies • Object oriented Analysis • Design and Programming • Cloud Computing • Big Data Analytics 	<ul style="list-style-type: none"> • Fundamentals of Computing • Embedded systems • Computer Architecture • Mobile computing Apps • Data Structure • Software Quality Management • Project Management • Projects works

Membership in Professional Bodies

- Life member - ISTE (LM38394), 2003 onwards
- Life member - CSI (00153292), 2004 onwards
- Life member – ISRD (F3140900610), 2016 onwards
- Vice- President of Computer Society of India (CSI), Salem Chapter, and Tamilnadu – 2012 to 2016.
- President in Computer Society of India (CSI), Salem Chapter, Tamilnadu. – 2018 to 2023.

Major Position Held

- Chief-Coordinator for NAAC: College level, K.S.R. College of Engineering (Autonomous), Period 2013-2017.
- Chief-Coordinator for NBA – College level, K.S.R. College of Engineering (Autonomous), from 2008 onwards.
- Best student Project selection committee member (Namakkal District) headed by district collector of Namakkal for 2015-2016 appointed by Government of Tamilnadu.
- Chairman – Board of Studies (BOS), Department of Information Technology, K.S.R. College of Engineering (Autonomous), Period 2011-2013 & 2013-2017, 2018-2021 to till date.
- Co-opted External Expert – Academic Council, Autonomous Body and BOS of Computer Science and Engineering (UG & PG) at K.S. Rangasamy college of Technology (Autonomous), Tiruchengode.
- Member- Staff Selection Committee, K.S.R. College of Engineering, Tiruchengode.

- **Coordinator of ICT Academy Tamil Nadu, EDP Cell (Funded by Government of Tamilnadu),** K.S.R. College of Engineering, Tiruchengode.
- **Coordinator for Industry Institute Partnership Cell (IIPC),** K.S.R. College of Engineering, Tiruchengode.
- **Member Question paper Setting Committee -** Karunya University, Dr.M.G.R.University, Karpagam University, Sastra University, Kumaraguru College of Technology (Autonomous), Kongu Engineering College (Autonomous), Chandrasekara Vidyala University, Sona college of Technology (Autonomous), Government College of Engineering (Autonomous), Annamalai University
- Mock interview – PANEL Member for Wipro-Training for 2017-2018.
- Training & Placement Head at KSRCE-2019 to till date.

Ph.D. Supervision Recognition		
Name of the University	Recognition Number	Approved Departments
Anna University, Chennai	1006101 / 2740085	Computer Science and Engineering, Information Technology, Electronic and Communication Engineering
Bharath University, Chennai	R14CS011	Computer Science and Engineering
VIT University, Vellore	1102433	Computer Science and Engineering.

Award & Recognitions

- Got **Best International Journal Paper** award for "A Tool for Testing Inheritance Related Bugs in Object oriented Software" in Directory of open access journal, SPARC EUROPE AWARD 2009.
- Management Information System – Oct 2005 – 100% Result, Anna University ,Chennai
- Management information system –Dec 2006 – 100% Result, Anna University ,Chennai
- Software testing - April 2006 – 100% Result, Anna University ,Chennai
- Software testing - May2007 – 100 % Result, Anna University ,Chennai
- Computer Programming - May 2007- 100% Result, Anna University ,Chennai
- Software engineering –May 2009 – 100 % Results, Anna University of Technology, Coimbatore.
- Software quality Management –April 2010 – 100 % Results, Anna University of Technology, Coimbatore
- Advanced computer Architecture – November 2011 -100 % results, Anna University of Technology, Coimbatore.
- Software Engineering Methodology – December 2014 – 100% results, Anna University, Chennai.
- **Best Teaching awards in Engineering for 2015** from Staffordshire University, UK and Education Matters.
- **Award for Achievements in Organizing FDP/Conferences** for 2014-15 from K.S.R College of Engineering (Autonomous), Tiruchengode.
- **Best support award** for International Conference on Advanced Theoretical computer Applications (ICATCA'16),organized by CAASR Publishers held at Kuala Lumpur , Malaysia on 5th & 6th May 2016.

- Elected as Chairman for Computer Society of India (CSI – Salem Chapter), Period of 2018-2020.
- **Awards-VIFA 2018** -'Distinguished Faculty in Engineering' in Computer Science and Engineering, Venus International Foundation, Chennai.
- **Visiting Professor** at Faculty of Computing, Universiti Teknologi Malaysia(UTM), Malaysia.2018-2019.
- **MOU** with ALIAS Research Group, Universiti Teknologi Malaysia(UTM), Malaysia.2018-2019.
- **Visit** Temesek Polytechnic at Singapore on 15.06.2018.
- **Education Excellence Award 2021** – Outstanding services along with brilliant and consistently high standard of work in the field of Education, Publication, Research and Development by Lead India, ESN Publication & Vision Digital India.
- **BEST EDUCATOR 2020-21** - International Educator Award 2020-21, instituted by the International Institute of organized Research (I2OR),by registered MSME.

Personal Details

Gender : Male
Date of Birth : 07th March 1974
Father's Name : B.T.Gnana Sambandam
Marital Status : Married
Nationality : Indian
Permanent Address : 93, Thiruneelakandar Street,
 Bhavani – 638 301,
 Erode district. Tamil Nadu, India.
 Phone: 04256-230194
Languages : Proficiency in Indian languages:
 1. English 2.Tamil 3.Malayalam

Reference

1. **Dr. A. Krishnan** : Dean
 K.S.R. College of Engineering (Autonomous)
 Tiruchengode,
akrishnan41@gmail.com
 + 91 9894911177
2. **Dr. V. Cyrilraj** : Dean - Academic
 Dr. M.G.R. Deemed University
 Maduravoyal, Chennai,
hod-cse@drmgrdu.au.in
 +91 9444129023



I assure that Information all above is true to my best of knowledge.

Place: Tiruchengode

[Dr. G. SINGARAVEL]

PRINCIPAL,
K.S.R. COLLEGE OF ENGINEERING
TIRUCHENGODE - 637 209

Dr. G. Singaravel
Professor & Head
 Department of Information Techno
 K.S.R. College of Engineering (Autono
 Tiruchengode - 637 215
 Namakkal (Dt), Tamilnadu, Indi.

CURRICULAM VITAE

Name : T Saran Sujai
Mail ID: saransujai@ksrce.ac.in
Contact No: 7639604922

Objective:

A challenging position in an organization that utilizes my knowledge and interpersonal skills as a professional and imparts confidence in me.

Professional Experience:

- Working as an Assistant professor in **K.S.R College of Engineering, Tiruchengode** from **June 2014 to Till date.**

Academic Qualification:

Branch	College	Percentage/ CGPA	Year of passing
M.E- PED	MNM Jain Engineering College	7.4 (CGPA)	2014
B.E-ECE	Adhiyamaann College of Engineering	64%	2009
HSC	John Dewey Matriculation Higher Secondary School	74%	2003
SSLC	John Dewey Matriculation Higher Secondary School	78%	2001

Software Exposure:

Languages	C, C++
Packages	MS-office, VB.net
Operating system	Windows XP, 2007, LINUX, Ubuntu

Area of Interest:

- Embedded Systems
- Digital Electronics

Academic Achievements:

- Participated in many of the National level technical Symposiums conducted by various colleges.
- Organized a guest lecture on "Latest trends in IT fields" on 17.9.2011 at Angel College of Engineering and Technology.
- Participated in a two days workshop on "Network Security and Its Challenges" from 19th August to 20th August at Angel College of Engineering and Technology.



Personal Details:

Father's Name : Mr. P. Thayanithi
Date of Birth : 30-08-1986
Gender : Male
Nationality : Indian
Permanent address : 284/28, Varma Garden, Chinna Kollapatti
Yercaud Main Road.
Salem - 636008
Alternate Email Id : saransujai@gmail.com

References:

- **Dr.G.SINGARAVEL ,**
Prof. / HOD, IT Dept.,
K.S.R College of Engineering, Tiruchengode.Phone:9943455245s

Declaration:

I hereby declare that the informations furnished above are true to the best of my knowledge.

PRINCIPAL
K.S.R. COLLEGE OF ENGINEERING
K.S.R. KALVI NAGAR,
TIRUCHENGODE-637 215

Place: Salem
Date:

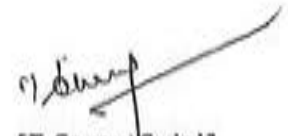

[T Saran Sujai]

Profile Outlook

Educator with over 13 years of experience who possesses the technical, interpersonal, and demonstration skills to successfully contribute to an academic institution.

Professional Summary

- 13 Years of professional experience as an academician in handling courses like Theory of Computation, Compiler Design, Object Oriented Programming using Java, Data Structures and Algorithms, Computer Architecture and business Intelligence.
- Strong technical expertise in Structured and Object Oriented Programming, Automation and Manual Testing, PL SQL Programming.

Technical Proficiency

- Databases : Oracle RDBMS 11g, MS Access
- Languages : C , Java, Python
- Scripting : SQL, PL SQL, UNIX Shell Scripting
- Query Tool : SQL Developer, SQLPlus
- Testing : Manual and Automation : Selenium

Educational Credentials

- **Masters of Engineering , Computer and Communication Engineering .**
Mahendra Engineering College (Anna University),8.36 CGPA , May 2012.

Certification

- **Oracle Certified Associate Java SE 8 Programmer - October 2018**

Personal Details

- Date of Birth : 7th April, 1983
- Languages Known : English & Tamil
- Passport Number : T1970780



G. S. 18/2/2022

Dr. G. Singaravel
Professor & Head
Department of Information Technology
K.S.R. College of Engineering (Autonomous)
Tiruchengode - 637 215
Nambakkal (Dt), Tamilnadu, India.

PRINCIPAL,
K. S. R. COLLEGE OF ENGINEERING,
TIRUCHENGODE - 637 209.

K.S.R. COLLEGE OF ENGINEERING (Autonomous)

(An Autonomous Institution, approved by AICTE, Accredited by NAAC with A grade
& Affiliated to Anna University)

**K.S.R. Kalvi Nagar, Tiruchengode – 637 215,
Namakkal District, Tamil Nadu**

Phone: 04288-274213

Fax: 04288-274757

E - mail: principal@ksrce.ac.in

Department of Information Technology

Phone :9943455245(HoD)

e - mail:ksrceitdept@gmail.com

Date: 13-07-2022

**Value added Course
On
“Software Manual Testing”**

Overview of this course:

- Manual Testing Syllabus, Software Testing is an important phase of the Software Development Life Cycle, Software Testing can be done in two ways, one is Manual Testing and another is Automated Testing or Test Automation.
- Manual Testing is the process in which requirements are analyzed and understood, Test scenarios are derived, Test cases are documented, Test cases are executed, and the defects are identified, isolated, subjected for justification, and ensure that the product is defect-free, in order to produce a quality product.

Through this course students will be able to:

- Understanding that what is Software testing?
- Understanding the Software development process.
- Understanding various Software development life cycle models.
- Understanding the Role of Software testing phase in Software development
- Understanding various Software test types.
- Tracking defects, confirmation testing, and closing the defects.
- Documenting of the test reports and test enclosure activities.



(S. Gowthaman)
COURSE CO-ORDINATOR

(S. Gowthaman)

G. S. S.
13/7/2022
HoD
Dr. G. Singaravel
Professor & Head
Department of Information Technology
K.S.R. College of Engineering (Autonomous)
Tiruchengode - 637 215
Namakkal District, Tamil Nadu, India.

(Signature)
PRINCIPAL

PRINCIPAL,
K.S.R. COLLEGE OF ENGINEERING,
TIRUCHENGODE 637 209.

ADVANTAGES OF MANUAL TESTING

Unmatched opportunities in usability testing (because only humans can access user-friendliness from a human point of view)



The chance to start testing right away without time for writing automated tests



Best fit for Ad-hoc testing (also referred to as random testing or monkey testing) that has no plan and can result in unexpected insights



Best fit for exploratory testing, often described as simultaneous test design and test execution, which lets QAs show maximum creativity



Lower testing costs per hour of QA engineer work

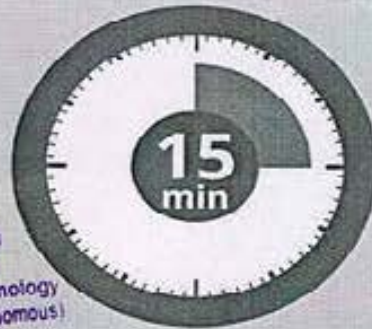

Best price/quality ratio for one-time or simple testing tasks



G. Singaravel
Dr. G. Singaravel
Professor & Head
Department of Information Technology
S.R. College of Engineering (Autonomous)
Tiruchengode - 637 215
Namakkal (Dt), Tamilnadu, India.



K.S.R COLLEGE OF ENGINEERING (AUTONOMOUS), TIRUCHENGODE – 637215

DEPARTMENT OF INFORMATION TECHNOLOGY

A VALUE ADDED COURSE ON “SOFTWARE MANUAL TESTING”

Date:14.07.2022

It is planned to conduct value added course on the topic “Software manual testing” third year students from 18.07.2022 to 22.07.2022. The following students have registered for the course.

S. No.	REG.NO	Name of the Student	Branch / Year
1.	2021001	ABISHEK.U	B.TECH-III
2.	2021002	ABISHEK.R.S	B.TECH-III
3.	2021003	BALAJI.M	B.TECH-III
4.	2021004	BATSHA. T	B.TECH-III
5.	2021005	BHARATHI.P	B.TECH-III
6.	2021006	BHASKARAPRASATH.S.K	B.TECH-III
7.	2021007	BHUVANESH.G	B.TECH-III
8.	2021008	DHANUSHYA.K	B.TECH-III
9.	2021009	DIVYA.K	B.TECH-III
10.	2021011	FARITHA BANU.M	B.TECH-III
11.	2021012	GIRIJA.V	B.TECH-III
12.	2021013	GNANAPRAKASH.J	B.TECH-III
13.	2021014	GOBIKA.C	B.TECH-III
14.	2021015	GOKUL.R	B.TECH-III
15.	2021016	GOKUL.V	B.TECH-III
16.	2021017	GOPI.M	B.TECH-III
17.	2021018	GOPINATH.N	B.TECH-III
18.	2021019	HARIPRASATH.S	B.TECH-III
19.	2021020	HARIPRIYA.G	B.TECH-III
20.	2021021	KALPANA.V	B.TECH-III
21.	2021022	KANISHKA.V	B.TECH-III
22.	2021023	KAVIN.S	B.TECH-III
23.	2021024	KAVIN KUMAR.R	B.TECH-III
24.	2021025	KISHORE.B	B.TECH-III
25.	2021026	LALITH KUMAR.R	B.TECH-III

26.	2021027	LOGA MOORTHY.S	B.TECH-III
27.	2021028	MANIBHARATHI.J	B.TECH-III
28.	2021029	MANIKANDAN.S	B.TECH-III
29.	2021030	MITHRA.S.P	B.TECH-III
30.	2021031	MOHAMEDFAHEEM.S	B.TECH-III
31.	2021032	MOHAN.G	B.TECH-III
32.	2021033	NITHEESHKUMAR.A	B.TECH-III
33.	2021034	PAVITHRA.S	B.TECH-III
34.	2021035	POOVARASAN.G(26-02-03)	B.TECH-III
35.	2021036	POOVARASAN.G(19-05-03)	B.TECH-III
36.	2021037	PRASANTH.N	B.TECH-III
37.	2021038	PRAVEENKUMAR.V	B.TECH-III
38.	2021039	PRAVINKUMAR.M	B.TECH-III
39.	2021040	PRIYANKA.P	B.TECH-III
40.	2021041	RAVISANKAR.G	B.TECH-III
41.	2021042	RITTHISH.R.V	B.TECH-III
42.	2021043	SANJAY.J	B.TECH-III
43.	2021044	SANTHOSH.A	B.TECH-III
44.	2021045	SATHISH.A	B.TECH-III
45.	2021046	SHARUKES.K	B.TECH-III
46.	2021047	SHARVESH.M	B.TECH-III
47.	2021048	SHEVAKSRI.P	B.TECH-III
48.	2021049	SRITHAR.S.V	B.TECH-III
49.	2021050	SUGANESH.G	B.TECH-III
50.	2021051	SURRIYAA.P.P	B.TECH-III
51.	2021052	SUWETHAA.M.K	B.TECH-III
52.	2021053	TAMILZHARASU.M.P	B.TECH-III
53.	2021054	VASANTH.P	B.TECH-III
54.	2021055	VASANTH.V	B.TECH-III
55.	2021056	VASUDEVAN.R	B.TECH-III
56.	2021057	VIGNESH.S	B.TECH-III
57.	2021058	VIGNESH.C	B.TECH-III
58.	2021059	VIMALAA SRI.V.S	B.TECH-III

59.	2021060	YUVASREE.S	B.TECH-III
60.	2021501	ESWAR CHANDAR, P	B.TECH-III
61.	2021502	GOWTHAMAN .S	B.TECH-III
62.	2021503	JEENATH .N	B.TECH-III
63.	2021504	PRAKASH .K	B.TECH-III
64.	2021505	SIVABALAN. G	B.TECH-III



[Signature]
Course coordinator
[S] Gowtham AP [IT]

[Signature]

PRINCIPAL
K.S.R. COLLEGE OF ENGINEERING
K.S.R. KALVI NAGAR,
TIRUCHENGODE-637 215

[Signature] 14/11/2022

HOD-IT
Dr. S. Srinivasan
Professor & Head
Department of Information Technology
K.S.R. College of Engineering (Autonomous)
Tiruchengode - 637 215
Tiruchengode (Dt), Tamilnadu, India

K.S.R COLLEGE OF ENGINEERING (AUTONOMOUS), TIRUCHENGODE – 637215
DEPARTMENT OF INFORMATION TECHNOLOGY

Name of the course : Software Manual Testing

Name of the resource person : Dr.G.Singaravel,Mr.G.Nagarajan and Mr.T.Saransujai

Course coordinator: Dr.K.Balamurugan and Mr.S.Gowtham

Date : 18.07.2022

Attendance sheet

S.NO	Reg. No.	Name	18/07/2022		19/07/2022		20/07/2022		21/07/2022		22/07/2022	
			FN	AN	FN	AN	FN	AN	FN	AN	FN	AN
1	2021001	ABISHEK.U	u.A.P	u.A.P	u.A.P	u.A.P	u.A.P	u.A.P	u.A.P	u.A.P	u.A.P	u.A.P
2	2021002	ABISHEK.R.S	Abishek	Abishek	Abishek	Abishek	Abishek	Abishek	Abishek	Abishek	Abishek	Abishek
3	2021003	BALAJI.M	Balaji	Balaji	Balaji	Balaji	Balaji	Balaji	Balaji	Balaji	Balaji	Balaji
4	2021004	BATSHA. T	Batsha	Batsha	Batsha	Batsha	Batsha	Batsha	Batsha	Batsha	Batsha	Batsha
5	2021005	BHARATHI.P	Bharathi	Bharathi	Bharathi	Bharathi	Bharathi	Bharathi	Bharathi	Bharathi	Bharathi	Bharathi
6	2021006	BHASKARAPRASATH.S.K	Bhaskar	Bhaskar	Bhaskar	Bhaskar	Bhaskar	Bhaskar	Bhaskar	Bhaskar	Bhaskar	Bhaskar
7	2021007	BHUVANESH.G	Bhuvanesh	Bhuvanesh	Bhuvanesh	Bhuvanesh	Bhuvanesh	Bhuvanesh	Bhuvanesh	Bhuvanesh	Bhuvanesh	Bhuvanesh
8	2021008	DHANUSHYA.K	Dhanushya	Dhanushya	Dhanushya	Dhanushya	Dhanushya	Dhanushya	Dhanushya	Dhanushya	Dhanushya	Dhanushya
9	2021009	DIVYA.K	Divya	Divya	Divya	Divya	Divya	Divya	Divya	Divya	Divya	Divya
10	2021011	FARITHA BANU.M	Faritha	Faritha	Faritha	Faritha	Faritha	Faritha	Faritha	Faritha	Faritha	Faritha
11	2021012	GIRIJA.V	Girija	Girija	Girija	Girija	Girija	Girija	Girija	Girija	Girija	Girija
12	2021013	GNANAPRAKASH.J	Gnanaprakash	Gnanaprakash	Gnanaprakash	Gnanaprakash	Gnanaprakash	Gnanaprakash	Gnanaprakash	Gnanaprakash	Gnanaprakash	Gnanaprakash
13	2021014	GOBIKA.C	Gobika	Gobika	Gobika	Gobika	Gobika	Gobika	Gobika	Gobika	Gobika	Gobika
14	2021015	GOKUL.R	Gokul	Gokul	Gokul	Gokul	Gokul	Gokul	Gokul	Gokul	Gokul	Gokul
15	2021016	GOKUL.V	Gokul	Gokul	Gokul	Gokul	Gokul	Gokul	Gokul	Gokul	Gokul	Gokul
16	2021017	GOPI.M	Gopi	Gopi	Gopi	Gopi	Gopi	Gopi	Gopi	Gopi	Gopi	Gopi
17	2021018	GOPINATH.N	Gopinath	Gopinath	Gopinath	Gopinath	Gopinath	Gopinath	Gopinath	Gopinath	Gopinath	Gopinath
18	2021019	HARIPRASATH.S	Hariprasath	Hariprasath	Hariprasath	Hariprasath	Hariprasath	Hariprasath	Hariprasath	Hariprasath	Hariprasath	Hariprasath
19	2021020	HARIPRIYA.G	Haripriya	Haripriya	Haripriya	Haripriya	Haripriya	Haripriya	Haripriya	Haripriya	Haripriya	Haripriya
20	2021021	KALPANA.V	Kalpana	Kalpana	Kalpana	Kalpana	Kalpana	Kalpana	Kalpana	Kalpana	Kalpana	Kalpana
21	2021022	KANISHKA.V	Kanishka	Kanishka	Kanishka	Kanishka	Kanishka	Kanishka	Kanishka	Kanishka	Kanishka	Kanishka
22	2021023	KAVIN.S	Kavin	Kavin	Kavin	Kavin	Kavin	Kavin	Kavin	Kavin	Kavin	Kavin
23	2021024	KAVIN KUMAR.R	Kavin	Kavin	Kavin	Kavin	Kavin	Kavin	Kavin	Kavin	Kavin	Kavin

24	2021025	KISHORE.B	B.Kishore	B.Kishore	B.Kishore	B.Kishore	B.Kishore	B.Kishore	B.Kishore	B.Kishore	B.Kishore	B.Kishore	B.Kishore
25	2021026	LALITH KUMAR.R	L.Kumar	L.Kumar	L.Kumar	L.Kumar	L.Kumar	L.Kumar	L.Kumar	L.Kumar	L.Kumar	L.Kumar	L.Kumar
26	2021027	LOGA MOORTHY.S	S.Moorthy	S.Moorthy	S.Moorthy	S.Moorthy	S.Moorthy	S.Moorthy	S.Moorthy	S.Moorthy	S.Moorthy	S.Moorthy	S.Moorthy
27	2021028	MANIBHARATHI.J	J.Manibharathi	J.Manibharathi	J.Manibharathi	J.Manibharathi	J.Manibharathi	J.Manibharathi	J.Manibharathi	J.Manibharathi	J.Manibharathi	J.Manibharathi	J.Manibharathi
28	2021029	MANIKANDAN.S	S.Manikandan	S.Manikandan	S.Manikandan	S.Manikandan	S.Manikandan	S.Manikandan	S.Manikandan	S.Manikandan	S.Manikandan	S.Manikandan	S.Manikandan
29	2021030	MITHRA.S.P	P.Mithra	P.Mithra	P.Mithra	P.Mithra	P.Mithra	P.Mithra	P.Mithra	P.Mithra	P.Mithra	P.Mithra	P.Mithra
30	2021031	MOHAMEDFAHEEM.S	S.Mohamedfaheem	S.Mohamedfaheem	S.Mohamedfaheem	S.Mohamedfaheem	S.Mohamedfaheem	S.Mohamedfaheem	S.Mohamedfaheem	S.Mohamedfaheem	S.Mohamedfaheem	S.Mohamedfaheem	S.Mohamedfaheem
31	2021032	MOHAN.G	G.Mohan	G.Mohan	G.Mohan	G.Mohan	G.Mohan	G.Mohan	G.Mohan	G.Mohan	G.Mohan	G.Mohan	G.Mohan
32	2021033	NITHEESHKUMAR.A	A.Nitheeshkumar	A.Nitheeshkumar	A.Nitheeshkumar	A.Nitheeshkumar	A.Nitheeshkumar	A.Nitheeshkumar	A.Nitheeshkumar	A.Nitheeshkumar	A.Nitheeshkumar	A.Nitheeshkumar	A.Nitheeshkumar
33	2021034	PAVITHRA.S	S.Pavithra	S.Pavithra	S.Pavithra	S.Pavithra	S.Pavithra	S.Pavithra	S.Pavithra	S.Pavithra	S.Pavithra	S.Pavithra	S.Pavithra
34	2021035	POOVARASAN.G(26-02-	G.Poovarasan	G.Poovarasan	G.Poovarasan	G.Poovarasan	G.Poovarasan	G.Poovarasan	G.Poovarasan	G.Poovarasan	G.Poovarasan	G.Poovarasan	G.Poovarasan
35	2021035	POOVARASAN.G(19-05-	G.Poovarasan	G.Poovarasan	G.Poovarasan	G.Poovarasan	G.Poovarasan	G.Poovarasan	G.Poovarasan	G.Poovarasan	G.Poovarasan	G.Poovarasan	G.Poovarasan
36	2021037	PRASANTH.N	N.Prasanth	N.Prasanth	N.Prasanth	N.Prasanth	N.Prasanth	N.Prasanth	N.Prasanth	N.Prasanth	N.Prasanth	N.Prasanth	N.Prasanth
37	2021038	PRAVEENKUMAR.V	V.Praveenkumar	V.Praveenkumar	V.Praveenkumar	V.Praveenkumar	V.Praveenkumar	V.Praveenkumar	V.Praveenkumar	V.Praveenkumar	V.Praveenkumar	V.Praveenkumar	V.Praveenkumar
38	2021039	PRAVINKUMAR.M	M.Pravinkumar	M.Pravinkumar	M.Pravinkumar	M.Pravinkumar	M.Pravinkumar	M.Pravinkumar	M.Pravinkumar	M.Pravinkumar	M.Pravinkumar	M.Pravinkumar	M.Pravinkumar
39	2021040	PRIYANKA.P	P.Priyanka	P.Priyanka	P.Priyanka	P.Priyanka	P.Priyanka	P.Priyanka	P.Priyanka	P.Priyanka	P.Priyanka	P.Priyanka	P.Priyanka
40	2021041	RAVISANKAR.G	G.Ravisankar	G.Ravisankar	G.Ravisankar	G.Ravisankar	G.Ravisankar	G.Ravisankar	G.Ravisankar	G.Ravisankar	G.Ravisankar	G.Ravisankar	G.Ravisankar
41	2021042	RITTHISH.R.V	R.V.Ritthish	R.V.Ritthish	R.V.Ritthish	R.V.Ritthish	R.V.Ritthish	R.V.Ritthish	R.V.Ritthish	R.V.Ritthish	R.V.Ritthish	R.V.Ritthish	R.V.Ritthish
42	2021043	SANJAY.J	J.Sanjay	J.Sanjay	J.Sanjay	J.Sanjay	J.Sanjay	J.Sanjay	J.Sanjay	J.Sanjay	J.Sanjay	J.Sanjay	J.Sanjay
43	2021044	SANTHOSH.A	A.Santhosh	A.Santhosh	A.Santhosh	A.Santhosh	A.Santhosh	A.Santhosh	A.Santhosh	A.Santhosh	A.Santhosh	A.Santhosh	A.Santhosh
44	2021045	SATHISH.A	A.Sathish	A.Sathish	A.Sathish	A.Sathish	A.Sathish	A.Sathish	A.Sathish	A.Sathish	A.Sathish	A.Sathish	A.Sathish
45	2021046	SHARUKES.K	K.Sharukes	K.Sharukes	K.Sharukes	K.Sharukes	K.Sharukes	K.Sharukes	K.Sharukes	K.Sharukes	K.Sharukes	K.Sharukes	K.Sharukes
46	2021047	SHARVESH.M	M.Sharvesh	M.Sharvesh	M.Sharvesh	M.Sharvesh	M.Sharvesh	M.Sharvesh	M.Sharvesh	M.Sharvesh	M.Sharvesh	M.Sharvesh	M.Sharvesh
47	2021048	SHEVAKSRI.P	P.ShevakSri	P.ShevakSri	P.ShevakSri	P.ShevakSri	P.ShevakSri	P.ShevakSri	P.ShevakSri	P.ShevakSri	P.ShevakSri	P.ShevakSri	P.ShevakSri
48	2021049	SRITHAR.S.V	S.V.Srithar	S.V.Srithar	S.V.Srithar	S.V.Srithar	S.V.Srithar	S.V.Srithar	S.V.Srithar	S.V.Srithar	S.V.Srithar	S.V.Srithar	S.V.Srithar
49	2021050	SUGANESH.G	G.Suganesh	G.Suganesh	G.Suganesh	G.Suganesh	G.Suganesh	G.Suganesh	G.Suganesh	G.Suganesh	G.Suganesh	G.Suganesh	G.Suganesh
50	2021051	SURRIYAA.P.P	P.P.Surriyaa	P.P.Surriyaa	P.P.Surriyaa	P.P.Surriyaa	P.P.Surriyaa	P.P.Surriyaa	P.P.Surriyaa	P.P.Surriyaa	P.P.Surriyaa	P.P.Surriyaa	P.P.Surriyaa
51	2021052	SUWETHAA.M.K	K.M.Suwethaa	K.M.Suwethaa	K.M.Suwethaa	K.M.Suwethaa	K.M.Suwethaa	K.M.Suwethaa	K.M.Suwethaa	K.M.Suwethaa	K.M.Suwethaa	K.M.Suwethaa	K.M.Suwethaa
52	2021053	TAMILZHARASU.M.P	P.M.Tamilzharasu	P.M.Tamilzharasu	P.M.Tamilzharasu	P.M.Tamilzharasu	P.M.Tamilzharasu	P.M.Tamilzharasu	P.M.Tamilzharasu	P.M.Tamilzharasu	P.M.Tamilzharasu	P.M.Tamilzharasu	P.M.Tamilzharasu
53	2021054	VASANTH.P	P.Vasanth	P.Vasanth	P.Vasanth	P.Vasanth	P.Vasanth	P.Vasanth	P.Vasanth	P.Vasanth	P.Vasanth	P.Vasanth	P.Vasanth
54	2021055	VASANTH.V	V.Vasanth	V.Vasanth	V.Vasanth	V.Vasanth	V.Vasanth	V.Vasanth	V.Vasanth	V.Vasanth	V.Vasanth	V.Vasanth	V.Vasanth
55	2021056	VASUDEVAN.R	R.Vasudevan	R.Vasudevan	R.Vasudevan	R.Vasudevan	R.Vasudevan	R.Vasudevan	R.Vasudevan	R.Vasudevan	R.Vasudevan	R.Vasudevan	R.Vasudevan
56	2021057	VIGNESH.S	S.Vignesh	S.Vignesh	S.Vignesh	S.Vignesh	S.Vignesh	S.Vignesh	S.Vignesh	S.Vignesh	S.Vignesh	S.Vignesh	S.Vignesh
57	2021058	VIGNESH.C	C.Vignesh	C.Vignesh	C.Vignesh	C.Vignesh	C.Vignesh	C.Vignesh	C.Vignesh	C.Vignesh	C.Vignesh	C.Vignesh	C.Vignesh

58	2021059	VIMALAA SRI.V.S	V.S.V.S	V.S.V.S	V.S.V.S	V.S.V.S	V.S.V.S	V.S.V.S	V.S.V.S	V.S.V.S	V.S.V.S	V.S.V.S
59	2021060	YUVASREE.S	Y.S.V.S	Y.S.V.S	Y.S.V.S	Y.S.V.S	Y.S.V.S	Y.S.V.S	Y.S.V.S	Y.S.V.S	Y.S.V.S	Y.S.V.S
60	2021501	ESWAR CHANDAR. P	E.C.P	E.C.P	E.C.P	E.C.P	E.C.P	E.C.P	E.C.P	E.C.P	E.C.P	E.C.P
61	2021502	GOWTHAMAN .S	G.S	G.S	G.S	G.S	G.S	G.S	G.S	G.S	G.S	G.S
62	2021503	JEENATH .N	J.N	J.N	J.N	J.N	J.N	J.N	J.N	J.N	J.N	J.N
63	2021504	PRAKASH .K	P.K	P.K	P.K	P.K	P.K	P.K	P.K	P.K	P.K	P.K
64	2021505	SIVABALAN. G	S.G	S.G	S.G	S.G	S.G	S.G	S.G	S.G	S.G	S.G
Total no. of Students			64	64	64	64	64	64	64	64	64	64
Present			61	61	61	61	60	60	60	62	62	62
Absent			03	03	03	03	04	04	04	02	02	02
Coordinator Signature			[Signature]	[Signature]	[Signature]	[Signature]	[Signature]	[Signature]	[Signature]	[Signature]	[Signature]	[Signature]
HoD / IT			[Signature]	[Signature]	[Signature]	[Signature]	[Signature]	[Signature]	[Signature]	[Signature]	[Signature]	[Signature]

Dr. G. Singaravel
 Professor & Head
 Department of Information Technology
 K.S.R. College of Engineering (Autonomous)
 Tiruchengode - 637 215
 Namakkal (Dt), Tamilnadu, India.

[Signature]
 PRINCIPAL,
 K.S.R. COLLEGE OF ENGINEERING,
 TIRUCHENGODE 637 203.



K.S.R COLLEGE OF ENGINEERING (AUTONOMOUS), TIRUCHENGODE - 637215

DEPARTMENT OF INFORMATION TECHNOLOGY

A VALUE ADDED COURSE ON "Software Manual Testing"

Date: 28.07.2022

GRADE SHEET

S. No.	Register. No	Name of the Student	Year	Grade	Signature
1.	2021001	ABISHEK.U	B.TECH-III	A	<i>[Signature]</i>
2.	2021002	ABISHEK.R.S	B.TECH-III	B	<i>Abishak-R.S</i>
3.	2021003	BALAJI.M	B.TECH-III	A	<i>[Signature]</i>
4.	2021004	BATSHA. T	B.TECH-III	A	<i>[Signature]</i>
5.	2021005	BHARATHI.P	B.TECH-III	A	<i>[Signature]</i>
6.	2021006	BHASKARAPRASATH.S.K	B.TECH-III	B	<i>[Signature]</i>
7.	2021007	BHUVANESH.G	B.TECH-III	B	<i>[Signature]</i>
8.	2021008	DHANUSHYA.K	B.TECH-III	A	<i>[Signature]</i>
9.	2021009	DIVYA.K	B.TECH-III	C	<i>[Signature]</i>
10.	2021011	FARITHA BANU.M	B.TECH-III	A	<i>[Signature]</i>
11.	2021012	GIRIJA.V	B.TECH-III	B	<i>[Signature]</i>
12.	2021013	GNANAPRAKASH.J	B.TECH-III	A	<i>[Signature]</i>
13.	2021014	GOBIKA.C	B.TECH-III	B	<i>[Signature]</i>
14.	2021015	GOKUL.R	B.TECH-III	C	<i>[Signature]</i>
15.	2021016	GOKUL.V	B.TECH-III	A	<i>[Signature]</i>
16.	2021017	GOPI.M	B.TECH-III	A	<i>[Signature]</i>
17.	2021018	GOPINATH.N	B.TECH-III	A	<i>[Signature]</i>
18.	2021019	HARIPRASATH.S	B.TECH-III	C	<i>[Signature]</i>
19.	2021020	HARIPRIYA.G	B.TECH-III	A	<i>[Signature]</i>
20.	2021021	KALPANA.V	B.TECH-III	B	<i>[Signature]</i>

21.	2021022	KANISHKA.V	B.TECH-III	A	V. Parvika
22.	2021023	KAVIN.S	B.TECH-III	A	S. S.
23.	2021024	KAVIN KUMAR.R	B.TECH-III	B	P. Vannakumar
24.	2021025	KISHORE.B	B.TECH-III	A	B. Kishore
25.	2021026	LALITH KUMAR.R	B.TECH-III	C	R. Lalitha
26.	2021027	LOGA MOORTHY.S	B.TECH-III	C	S. Muthy
27.	2021028	MANIBHARATHI.J	B.TECH-III	A	J. M.
28.	2021029	MANIKANDAN.S	B.TECH-III	B	M. Manikandan
29.	2021030	MITHRA.S.P	B.TECH-III	C	S.P. Mithra
30.	2021031	MOHAMEDFAHEEM.S	B.TECH-III	C	S. Mohamadaheem
31.	2021032	MOHAN.G	B.TECH-III	A	G. Mohan
32.	2021033	NITHEESHKUMAR.A	B.TECH-III	B	N. Nitheesh
33.	2021034	PAVITHRA.S	B.TECH-III	C	S. Pavithra
34.	2021035	POOVARASAN.G(26-02-03)	B.TECH-III	A	G. Poovarasana
35.	2021035	POOVARASAN.G(19-05-03)	B.TECH-III	A	G. Poovarasana
36.	2021037	PRASANTH.N	B.TECH-III	B	N. Prasant
37.	2021038	PRAVEENKUMAR.V	B.TECH-III	C	V. Praveen
38.	2021039	PRAVINKUMAR.M	B.TECH-III	C	M. Pravinkumar
39.	2021040	PRIYANKA.P	B.TECH-III	A	P. Priyanka
40.	2021041	RAVISANKAR.G	B.TECH-III	B	G. Ravisankar
41.	2021042	RITTHISH.R.V	B.TECH-III	C	R. Ritthish
42.	2021043	SANJAY.J	B.TECH-III	A	J. Sanjay
43.	2021044	SANTHOSH.A	B.TECH-III	A	A. Santhosh
44.	2021045	SATHISH.A	B.TECH-III	A	A. Sathish
45.	2021046	SHARUKES.K	B.TECH-III	A	K. Sharukesh
46.	2021047	SHARVESH.M	B.TECH-III	C	M. Sharvesh
47.	2021048	SHEVAKSRI.P	B.TECH-III	C	P. Shevakshri

48.	2021049	SRITHAR.S.V	B.TECH-III	B	S.V.S
49.	2021050	SUGANESH.G	B.TECH-III	B	G. Sany.
50.	2021051	SURRIYAA.P.P	B.TECH-III	A	P.P.S
51.	2021052	SUWETHAA.M.K	B.TECH-III	A	M.K.S
52.	2021053	TAMILZHARASU.M.P	B.TECH-III	C	Tamilcharaf.
53.	2021054	VASANTH.P	B.TECH-III	C	P. Vasanth.
54.	2021055	VASANTH.V	B.TECH-III	A	V.V.
55.	2021056	VASUDEVAN.R	B.TECH-III	B	Vasudh.
56.	2021057	VIGNESH.S	B.TECH-III	C	S. Vignesh.
57.	2021058	VIGNESH.C	B.TECH-III	A	Vignesh.C
58.	2021059	VIMALAA SRI.V.S	B.TECH-III	C	V.S.Vinodini
59.	2021060	YUVASREE.S	B.TECH-III	C	S. Yuvaree.
60.	2021501	ESWAR CHANDAR. P	B.TECH-III	A	Chand.
61.	2021502	GOWTHAMAN .S	B.TECH-III	B	S. Gowthaman.
62.	2021503	JEENATH .N	B.TECH-III	C	N. Jeenth.
63.	2021504	PRAKASH .K	B.TECH-III	B	K. Prakash.
64.	2021505	SIVABALAN. G	B.TECH-III	A	G. Sivabalan.

91-100 O (Outstanding); 81-90 A+ (Excellent);

71-80 A (Very Good); 65-70 B+ (Good) ;60-65 B (Average); RA>60



COURSE CO-ORDINATOR

[S. Gowthaman]

PRINCIPAL,
K S R COLLEGE OF ENGINEERING
TIRUCHENGODE 637 209

G. S. S. P
28/7/2022

Dr. G. S. S. P
Professor & Head

Department of Information Technology
K. S. R. College of Engineering (Autonomous)
Tiruchengode - 637 216
Tirumakal (Dt), Tamilnadu, India.

K.S.R COLLEGE OF ENGINEERING(Autonomous), TIRUCHENGODE – 637 215
DEPARTMENT OF INFORMATION TECHNOLOGY
FEED BACK FORM

Kindly spare a few minutes and fill up the form to help us to improve our efforts in future.

Name of the Programme : *Value added course on "Software Manual Testing" 18.07.2022 - 22.07.2022, F – Block, R2S Lab, KSRCE Campus.*

Name of the Student : *S. Parvitha*

Register No. : *2021034*

Kindly evaluate in the following scale by ticking on the relevant grade.

1. Very Good *2.* Good 3. Satisfactory 4. Unsatisfactory

1. Did you find the Event useful?	1	2	<i>3</i>	4
2. Did it cover what you were expecting?	1	2	3	<i>4</i>
3. The content was helpful.	1	2	<i>3</i>	4
4. The level of the event was appropriate.	1	2	<i>3</i>	4
5. The format was enjoyable.	1	2	<i>3</i>	4
6. Did you receive all the information?	1	2	3	<i>4</i>
7. The speaker had a good understanding of the topics.	1	2	<i>3</i>	4
8. Whether the event worth your time?	1	2	3	<i>4</i>
9. The length of the event was appropriate.	1	2	<i>3</i>	4
10. Is the facilities were adequate and comfortable?	1	2	3	<i>4</i>



Date: *22.07.2022*

G. S. S. 22/3/22

Dr. G. Singaravel
Professor & Head

Department of Information Technology
 K.S.R. College of Engineering (Autonomous)
 Tiruchengode - 637 215

[Signature]

PRINCIPAL

K.S.R. COLLEGE OF ENGINEERING
 TIRUCHENGODE - 637 209.

[Signature]

Students Signature

K.S.R COLLEGE OF ENGINEERING(Autonomous), TIRUCHENGODE – 637 215
DEPARTMENT OF INFORMATION TECHNOLOGY
FEED BACK FORM

Kindly spare a few minutes and fill up the form to help us to improve our efforts in future.

Name of the Programme : *Value added course on "Software Manual Testing" 18.07.2022 - 22.07.2022, F – Block, R2S Lab, KSRCE Campus.*

Name of the Student : *Gobika . C*

Register No. : *2021014*

Kindly evaluate in the following scale by ticking on the relevant grade.

1. Very Good *2* Good 3. Satisfactory 4. Unsatisfactory

1. Did you find the Event useful?	1	2	3	<i>4</i>
2. Did it cover what you were expecting?	1	2	3	<i>4</i>
3. The content was helpful.	1	2	3	<i>4</i>
4. The level of the event was appropriate.	1	2	<i>3</i>	4
5. The format was enjoyable.	1	2	<i>3</i>	4
6. Did you receive all the information?	1	2	3	<i>4</i>
7. The speaker had a good understanding of the topics.	1	2	<i>3</i>	4
8. Whether the event worth your time?	1	2	3	<i>4</i>
9. The length of the event was appropriate.	1	2	<i>3</i>	4
10. Is the facilities were adequate and comfortable?	1	2	<i>3</i>	4

Date: *12.7.2022*



G. S. P.
 Professor & Head
 Department of Information Technology
 K.S.R. College of Engineering (Autonomous)
 Tiruchengode - 637, 215
 Tamil Nadu, India

Gobika . C
 PRINCIPAL,
 K.S.R. COLLEGE OF ENGINEERING
 TIRUCHENGODE - 637 209. Students Signature

5



K.S.R. COLLEGE OF ENGINEERING, TIRUCHENGODE

(An Autonomous Institution, NAAC Accredited, Affiliated to Anna University, Chennai)

Department of Master of Computer Applications

Date: 09.09.2021

Submitted to Principal

Sub.: Requesting permission for organizing Value Added Courses – Reg.,

The department of MCA has planned to conduct a Value Added Course entitled "Python Programming basics to Advanced" from 13.09.2021 to 18.09.2021. Kindly grant us permission to conduct the Value Added Course and utilize the Laboratory facilities available in our institution.



Yours faithfully,

Head of the Department
Department of Computer Applications
K.S.R. College of Engineering
Tiruchengode - 637 215

PRINCIPAL
K S R COLLEGE OF ENGINEERING,
(AUTONOMOUS)
TIRUCHENGODE - 637 215



K.S.R. COLLEGE OF ENGINEERING

(An Autonomous Institution, NAAC Accredited, Affiliated to Anna University, Chennai)

K.S.R. Kalvi Nagar, Tiruchengode – 637 215,

Namakkal DT, Tamil Nadu

We cordially invite for a

Value Added Course on *“Python Programming basics to Advanced”*

Resource Person

*Dr.M.Geetha MCA.,
Associate Professor,
Department of Computer Applications,
K.S.R.College of Engineering,
Tiruchengode.*

has magnanimously agreed to deliver a guest lecture

*Lion. Dr. K.S. RANGASAMY, MJF
Founder, K.S.R. Educational Institutions.*

has kindly agreed to deliver the chairman's address

*Thiru. R. SRINIVASAN, B.B.M., MISTE.,
Chairman & Managing Trustee, K.S.R. Educational Institutions*

will grace the function with his august presence

Dr. P. SENTHIL KUMAR

Principal, K.S.R. College of Engineering

will deliver the presidential address

All are Welcome

Date: 13.09.2021, 9.30 AM



Venue : MCA LAB 1

**PRINCIPAL
K.S.R. COLLEGE OF ENGINEERING,
(AUTONOMOUS)
TIRUCHENGODE - 637 215.**

AGENDA

Prayer Song		
Welcome Address	:	Mr. S.Tamilselvan, Asst. Professor / MCA K.S.R. College of Engineering.
Presidential Address	:	Principal K.S.R. College of Engineering
Inaugural Address	:	Dr. P.Anitha, HOD/MCA, K.S.R. College of Engineering.
Vote of Thanks	:	Mr. N.Prakash Asst. Professor / MCA K.S.R. College of Engineering.
National Anthem		



PRINCIPAL
K.S.R. COLLEGE OF ENGINEERING
K.S.R. KALVI NAGAR,
T. BUCHENGODE-637 215

K.S.R. COLLEGE OF ENGINEERING, TIRUCHENGODE – 637215

DEPARTMENT OF COMPUTER APPLICATIONS

PROGRAMME SCHEDULE

Venue : MCA Lab – I

Resource Person : Dr. M. Geetha MCA.,

S.No.	Date	Fore Noon (9.30am to 12.30pm)	After Noon (1.30 pm to 4.30 pm)
1	13.09.2021	Fundamentals of the Language	Applying the Python Libraries
2	14.09.2021	Application Development	Web Development
3	15.09.2021	Cross-platform Development Inside Python	Python Files Python Object & Class
4	16.09.2021	Python Advanced Topics	Python Date & Time
5	17.09.2021	Python Iterators	Python Decorators
6	18.09.2021	Python @property	Python RegEx



HOD-MCA
Head of the Department
Department of Computer Applications
K.S.R. College of Engineering
Tiruchengode - 637 215

PRINCIPAL
K.S.R. COLLEGE OF ENGINEERING,
(AUTONOMOUS)
TIRUCHENGODE - 637 215.

Course Objectives:

- Master the fundamentals of writing Python scripts.
- Learn core Python scripting elements such as variables and flow control structures.
- Discover how to work with lists and sequence data.
- Write Python functions to facilitate code reuse.
- Use Python to read and write files.

Course Outcomes:

- Understand computer architecture and data representations (variables, representation of numbers and character strings).
- Learn basic algorithmic problem-solving techniques (decision structures, loops, functions).
- Use and understand objects used in programming.
- Design, document, implement and test solutions to programming problems.
- Identify and repair coding errors in a program.



PRINCIPAL
KSR COLLEGE OF ENGINEERING
(AUTONOMOUS)
TIRUCHENGODE - 637 216.

K.S.R. COLLEGE OF ENGINEERING, TIRUCHENGODE - 637215

DEPARTMENT OF COMPUTER APPLICATIONS

VALUE ADDED COURSE

PYTHON PROGRAMMING PROBLEM SOLVING

S.No.	Name	Register No.
1	AJITH P	2062001
2	AKSHAYA K R	2062002
3	ASWINI S	2062003
4	BAKYA N	2062004
5	DHARANI M	2062005
6	DINESHKANNA M	2062006
7	DIVYAPRABHA N	2062007
8	ELANGO V R	2062008
9	FARDOSH A	2062009
10	GOKUL A	2062010
11	ISWARYA V	2062011
12	JAYA SHREE D	2062012
13	JEEVA K	2062013
14	KARTHIKEYAN G	2062014
15	KAVINKUMAR M	2062015
16	KRISHNAN S	2062016
17	LAVANYA A	2062017
18	LOGAPRIYA S	2062018
19	LOGU P	2062019
20	MATHAN B	2062020
21	MATHIYALAGAN S	2062021
22	MOHAN S	2062022
23	PAVITHRA S	2062023
24	PRIYADHARSHINI S	2062024
25	SELVAPOOVARASAN R	2062025
26	SETHUPATHI S V	2062026
27	SHALINI A	2062027
28	SHALINI J	2062028
29	SHANMUGAPRIYA M	2062029
30	SUBATHRA T	2062030



PRINCIPAL
K.S.R. COLLEGE OF ENGINEERING,
(AUTONOMOUS)
TIRUCHENGODE - 637 215.

31	THILAGAVATHI C	2062031	89
32	VASANTHI S	2062032	92
33	VIGNESH T	2062033	96



Head of the Department
Department of Computer Applications
K.S.R. College of Engineering
Tiruchengode - 627 015



PRINCIPAL
K.S.R. COLLEGE OF ENGINEERING
K.S.R. NAUVI NAGAR,
TIRUCHENGODE-627 015

K.S.R. COLLEGE OF ENGINEERING, TIRUCHENGODE - 637215

DEPARTMENT OF COMPUTER APPLICATIONS







VALUE ADDED COURSE

PYTHON PROGRAMMING BASIC TO ADVANCED

S.No.	Name	Register No.	13.09.2021	14.09.2021	15.09.2021	16.09.2021	17.09.2021	18.09.2021
1	AJITH P	2062001	/	/	/	/	/	/
2	AKSHAYA K R	2062002	/	/	/	/	/	/
3	ASWINI S	2062003	/	/	/	/	/	/
4	BAKYA N	2062004	/	/	/	/	/	/
5	DHARANI M	2062005	/	/	/	/	/	/
6	DINESHKANNA M	2062006	/	/	/	/	/	/
7	DIVYAPRABHA N	2062007	/	/	/	/	/	/
8	ELANGO V R	2062008	/	/	/	/	/	/
9	FARDOSH A	2062009	/	/	/	/	/	/
10	GOKUL A	2062010	/	/	/	/	/	/
11	ISWARYA V	2062011	/	/	/	/	/	/
12	JAYA SHREE D	2062012	/	/	/	/	/	/
13	JEEVA K	2062013	/	/	/	/	/	/
14	KARTHIKEYAN G	2062014	/	/	/	/	/	/
15	KAVINKUMAR M	2062015	/	/	/	/	/	/
16	KRISHNAN S	2062016	/	/	/	/	/	/
17	LAVANYA A	2062017	/	/	/	/	/	/
18	LOGAPRIYA S	2062018	/	/	/	/	/	/
19	LOGU P	2062019	/	/	/	/	/	/
20	MATHAN B	2062020	/	/	/	/	/	/
21	MATHIYALAGAN S	2062021	/	/	/	/	/	/
22	MOHAN S	2062022	/	/	/	/	/	/
23	PAVITHRA S	2062023	/	/	/	/	/	/
24	PRIYADHARSHINI S	2062024	/	/	/	/	/	/
25	SELVAPOOVARASAN R	2062025	/	/	/	/	/	/
26	SETHUPATHI S V	2062026	/	/	/	/	/	/
27	SHALINI A	2062027	/	/	/	/	/	/



PRINCIPAL
K.S.R. COLLEGE OF ENGINEERING,
(AUTONOMOUS)

28	SHALINI J	2062028	/	/	/	/	/	/
29	SHANMUGAPRIYA M	2062029	/	/	/	/	/	/
30	SUBATHRA T	2062030	/	/	/	/	/	/
31	THILAGAVATHI C	2062031	/	/	/	/	/	/
32	VASANTHI S	2062032	/	/	/	/	/	/
33	VIGNESH T	2062033						

Co - Ordinator

HOD/MCA

Head of the Department
 Department of Computer Applications
 K.S.R. College of Engineering
 Tiruchengode - 637 215

PRINCIPAL
K.S.R. COLLEGE OF ENGINEERING
 K.S.R. KALVI NAGAR,
 TIRUCHENGODE-637 215

K.S.R. COLLEGE OF ENGINEERING, TIRUCHENGODE - 637215

DEPARTMENT OF COMPUTER APPLICATIONS

VALUE ADDED COURSE

PYTHON PROGRAMMING PROBLEM SOLVING

S.No.	Name	Register No.	Mark
1	AJITH P	2062001	95
2	AKSHAYA K R	2062002	96
3	ASWINI S	2062003	98
4	BAKYA N	2062004	85
5	DHARANI M	2062005	86
6	DINESHKANNA M	2062006	82
7	DIVYAPRABHA N	2062007	88
8	ELANGO V R	2062008	99
9	FARDOSH A	2062009	98
10	GOKUL A	2062010	86
11	ISWARYA V	2062011	85
12	JAYA SHREE D	2062012	95
13	JEEVA K	2062013	86
14	KARTHIKEYAN G	2062014	85
15	KAVINKUMAR M	2062015	81
16	KRISHNAN S	2062016	82
17	LAVANYA A	2062017	95
18	LOGAPRIYA S	2062018	93
19	LOGU P	2062019	83
20	MATHAN B	2062020	92
21	MATHIYALAGAN S	2062021	94
22	MOHAN S	2062022	96
23	PAVITHRA S	2062023	86
24	PRIYADHARSHINI S	2062024	85
25	SELVAPOOVARASAN R	2062025	85
26	SETHUPATHI S V	2062026	96
27	SHALINI A	2062027	94
28	SHALINI J	2062028	82
29	SHANMUGAPRIYA M	2062029	83
30	SUBATHRA T	2062030	94



PRINCIPAL
K S R COLLEGE OF ENGINEERING,
(AUTONOMOUS)
TIRUCHENGODE - 637 215.

31	THILAGAVATHI C	2062031
32	VASANTHI S	2062032
33	VIGNESH T	2062033



Head of the Department
Department of Computer Applications
K.S.R. College of Engineering
Tiruchengode - 627 215



PRINCIPAL
K.S.R. COLLEGE OF ENGINEERING
K.S.R. KALVI NAGAR,
TIRUCHENGODE-637,215

Uses of Python

- shell tools
 - system admin tools, command line programs
- extension-language work
- rapid prototyping and development
- language-based modules
 - instead of special-purpose parsers
- graphical user interfaces
- database access
- distributed programming
- Internet scripting

5-Aug-22

Advanced Programming
Spring 2002



What not to use Python (and kin) for

- most scripting languages share these
- not as efficient as C
 - but sometimes better built-in algorithms (e.g., hashing and sorting)
- delayed error notification
- lack of profiling tools

5-Aug-22



PRINCIPAL
K.S.R. COLLEGE OF ENGINEERING
K.S.R. KALVI NAGAR,
TIRUCHENGODE-637 215
Advanced Programming
Spring 2002

Python structure

- modules: Python source files or C extensions
 - import, top-level via from, reload
- statements
 - control flow
 - create objects
 - indentation matters – instead of { }
- objects
 - everything is an object
 - automatically reclaimed when no longer needed

5-Aug-22

PRINCIPAL
K.S.R. COLLEGE OF ENGINEERING
K.S.R. KALVI NAGAR,
TIRUCHENGODE-637 215

Advanced Programming
Spring 2002



PRINCIPAL,
K.S.R. COLLEGE OF ENGINEERING,
(AUTONOMOUS),
TIRUCHENGODE - 637 215.



First example

```
#!/usr/local/bin/python
# import systems module
import sys
marker = ':::::'
for name in sys.argv[1:]:
    input = open(name, 'r')
    print marker + name
    print input.read()
```



PRINCIPAL
K.S.R. COLLEGE OF ENGINEERING
K.S.R. KALVI NAGAR,
TIRUCHENGODE-637 215

Basic operations

- Assignment:
 - `size = 40`
 - `a = b = c = 3`
- Numbers
 - integer, float
 - complex numbers: `1j+3`, `abs(z)`
- Strings
 - `'hello world'`, `'it\'s hot'`
 - `"bye world"`
 - continuation via `\` or use `""" long text """`

5-Aug-22

Advanced Programming
Spring 2002



String operations

- concatenate with + or neighbors
 - word = 'Hello' + x
 - word = 'Hello' 'a'
- subscripting of strings
 - 'Hello' [2] → 'l'
 - slice: 'Hello' [1:2] → 'el'
 - word[-1] → last character
 - len(word) → 5
 - immutable: cannot assign to subscript



5-Aug-22

PRINCIPAL
K.S.R. COLLEGE OF ENGINEERING
K.S.R. KALVI NAGAR,
TIRUCHENGODE-637 215

Advanced Programming
Spring 2002

Lists

- lists can be heterogeneous
 - `a = ['spam', 'eggs', 100, 1234, 2*2]`
- Lists can be indexed and sliced:
 - `a[0] → spam`
 - `a[:2] → ['spam', 'eggs']`
- Lists can be manipulated
 - `a[2] = a[2] + 23`
 - `a[0:2] = [1, 12]`
 - `a[0:0] = []`
 - `len(a) → 5`



Basic programming

```
a,b = 0, 1
# non-zero = true
while b < 10:
    # formatted output, without \n
    print b,
    # multiple assignment
    a,b = b, a+b
```



5-Aug-22

PRINCIPAL
K.S.R. COLLEGE OF ENGINEERING
K.S.R. KALVI NAGAR,
TIRUCHENGODE-637.215

Advanced Programming
Spring 2002

Control flow: if

```
x = int(raw_input("Please enter #:"))
if x < 0:
    x = 0
    print 'Negative changed to zero'
elif x == 0:
    print 'Zero'
elif x == 1:
    print 'Single'
else:
    print 'More'
▪ no case statement
```

5-Aug-22

Advanced Programming
Spring 2002



Control flow: for

```
a = ['cat', 'window', 'defenestrate']  
for x in a:  
    print x, len(x)
```

- no arithmetic progression, but
 - `range(10) → [0, 1, 2, 3, 4, 5, 6, 7, 8, 9]`
 - `for i in range(len(a)):`
 `print i, a[i]`
- do not modify the sequence being iterated over



K.S.R COLLEGE OF ENGINEERING(Autonomous), TIRUCHENGODE – 637 215
DEPARTMENT OF COMPUTER APPLICATIONS
FEED BACK FORM

Kindly spare a few minutes and fill up the form to help us to improve our efforts in future.

Name of the Programme: *Value added course on "Python Programming Basis to Advanced"*
 13.09.2021 to 18.09.2021., *C-Block, MCA LAB 1, KSRCE*
Campus.

Name of the Student : *Ajith P*

Register No. : *2062001*

Kindly evaluate in the following scale by ticking on the relevant grade.

1. Very Good 2. Good 3. Satisfactory 4. Unsatisfactory

- | | | | | |
|--|-------------------------------------|-------------------------------------|---|---|
| 1. Did you find the Event useful? | 1 | <input checked="" type="checkbox"/> | 3 | 4 |
| 2. Did it cover what you were expecting? | 1 | <input checked="" type="checkbox"/> | 3 | 4 |
| 3. The content was helpful. | <input checked="" type="checkbox"/> | 2 | 3 | 4 |
| 4. The level of the event was appropriate. | <input checked="" type="checkbox"/> | 2 | 3 | 4 |
| 5. The format was enjoyable. | <input checked="" type="checkbox"/> | 2 | 3 | 4 |
| 6. Did you receive all the information? | <input checked="" type="checkbox"/> | 2 | 3 | 4 |
| 7. The speaker had a good understanding of the topics. | 1 | <input checked="" type="checkbox"/> | 3 | 4 |
| 8. Whether the event worth your time? | 1 | <input checked="" type="checkbox"/> | 3 | 4 |
| 9. The length of the event was appropriate. | <input checked="" type="checkbox"/> | 2 | 3 | 4 |
| 10. Is the facilities were adequate and comfortable? | <input checked="" type="checkbox"/> | 2 | 3 | 4 |



Date: *18.09.2021*

 Students Signature
PRINCIPAL
 K.S.R. COLLEGE OF ENGINEERING,
 (AUTONOMOUS)
 TIRUCHENGODE - 637 215.

K.S.R COLLEGE OF ENGINEERING(Autonomous), TIRUCHENGODE – 637 215
DEPARTMENT OF COMPUTER APPLICATIONS
FEED BACK FORM

Kindly spare a few minutes and fill up the form to help us to improve our efforts in future.

Name of the Programme: *Value added course on “Python Programming Basis to Advanced”*
13.09.2021 to 18.09.2021., C-Block, MCA LAB I, KSRCE
Campus.

Name of the Student : *LOGU P*
 Register No. : *2062019*

Kindly evaluate in the following scale by ticking on the relevant grade.

1. Very Good 2. Good 3. Satisfactory 4. Unsatisfactory

- | | | | | | | |
|--|-------------------------------------|---|-------------------------------------|---|--------------------------|---|
| 1. Did you find the Event useful? | <input checked="" type="checkbox"/> | 2 | <input type="checkbox"/> | 3 | <input type="checkbox"/> | 4 |
| 2. Did it cover what you were expecting? | <input checked="" type="checkbox"/> | 2 | <input type="checkbox"/> | 3 | <input type="checkbox"/> | 4 |
| 3. The content was helpful. | <input type="checkbox"/> | 1 | <input checked="" type="checkbox"/> | 2 | <input type="checkbox"/> | 3 |
| 4. The level of the event was appropriate. | <input type="checkbox"/> | 1 | <input checked="" type="checkbox"/> | 2 | <input type="checkbox"/> | 3 |
| 5. The format was enjoyable. | <input checked="" type="checkbox"/> | 2 | <input type="checkbox"/> | 3 | <input type="checkbox"/> | 4 |
| 6. Did you receive all the information? | <input checked="" type="checkbox"/> | 2 | <input type="checkbox"/> | 3 | <input type="checkbox"/> | 4 |
| 7. The speaker had a good understanding of the topics. | <input type="checkbox"/> | 1 | <input checked="" type="checkbox"/> | 2 | <input type="checkbox"/> | 3 |
| 8. Whether the event worth your time? | <input type="checkbox"/> | 1 | <input checked="" type="checkbox"/> | 2 | <input type="checkbox"/> | 3 |
| 9. The length of the event was appropriate. | <input checked="" type="checkbox"/> | 2 | <input type="checkbox"/> | 3 | <input type="checkbox"/> | 4 |
| 10. Is the facilities were adequate and comfortable? | <input checked="" type="checkbox"/> | 2 | <input type="checkbox"/> | 3 | <input type="checkbox"/> | 4 |



Date: *18-09.2021*

LOGU P.
 Students Signature
 PRINCIPAL
 K.S.R COLLEGE OF ENGINEERING
 (AUTONOMOUS)
 TIRUCHENGODE - 637 215.

K.S.R COLLEGE OF ENGINEERING(Autonomous), TIRUCHENGODE – 637 215
DEPARTMENT OF COMPUTER APPLICATIONS
FEED BACK FORM

Kindly spare a few minutes and fill up the form to help us to improve our efforts in future.

Name of the Programme: *Value added course on "Python Programming Basis to Advanced"*
13.09.2021 to 18.09.2021., C-Block, MCA LAB 1, KSRCE
Campus.

Name of the Student : *Pavithra S.*

Register No. : *2062023*

Kindly evaluate in the following scale by ticking on the relevant grade.

1. Very Good 2. Good 3. Satisfactory 4. Unsatisfactory

- | | | | | | | |
|--|-------------------------------------|---|-------------------------------------|---|--------------------------|---|
| 1. Did you find the Event useful? | <input checked="" type="checkbox"/> | 2 | <input type="checkbox"/> | 3 | <input type="checkbox"/> | 4 |
| 2. Did it cover what you were expecting? | <input checked="" type="checkbox"/> | 2 | <input type="checkbox"/> | 3 | <input type="checkbox"/> | 4 |
| 3. The content was helpful. | <input type="checkbox"/> | 1 | <input checked="" type="checkbox"/> | 2 | <input type="checkbox"/> | 3 |
| 4. The level of the event was appropriate. | <input type="checkbox"/> | 1 | <input checked="" type="checkbox"/> | 2 | <input type="checkbox"/> | 3 |
| 5. The format was enjoyable. | <input checked="" type="checkbox"/> | 2 | <input type="checkbox"/> | 3 | <input type="checkbox"/> | 4 |
| 6. Did you receive all the information? | <input checked="" type="checkbox"/> | 2 | <input type="checkbox"/> | 3 | <input type="checkbox"/> | 4 |
| 7. The speaker had a good understanding of the topics. | <input checked="" type="checkbox"/> | 2 | <input type="checkbox"/> | 3 | <input type="checkbox"/> | 4 |
| 8. Whether the event worth your time? | <input type="checkbox"/> | 1 | <input checked="" type="checkbox"/> | 2 | <input type="checkbox"/> | 3 |
| 9. The length of the event was appropriate. | <input type="checkbox"/> | 1 | <input checked="" type="checkbox"/> | 2 | <input type="checkbox"/> | 3 |
| 10. Is the facilities were adequate and comfortable? | <input checked="" type="checkbox"/> | 2 | <input type="checkbox"/> | 3 | <input type="checkbox"/> | 4 |

Date:



S. Pavithra
Students Signature

K.S.R COLLEGE OF ENGINEERING(Autonomous), TIRUCHENGODE – 637 215
DEPARTMENT OF COMPUTER APPLICATIONS
FEED BACK FORM

Kindly spare a few minutes and fill up the form to help us to improve our efforts in future.

Name of the Programme: *Value added course on "Python Programming Basis to Advanced"*
13.09.2021 to 18.09.2021., C-Block, MCA LAB 1, KSRCE
Campus.

Name of the Student : *Jeeva.K*

Register No. : *2062013*

Kindly evaluate in the following scale by ticking on the relevant grade.

1. Very Good 2. Good 3. Satisfactory 4. Unsatisfactory

- | | | | | |
|--|-------------------------------------|-------------------------------------|---|---|
| 1. Did you find the Event useful? | 1 | <input checked="" type="checkbox"/> | 3 | 4 |
| 2. Did it cover what you were expecting? | <input checked="" type="checkbox"/> | 2 | 3 | 4 |
| 3. The content was helpful. | 1 | <input checked="" type="checkbox"/> | 3 | 4 |
| 4. The level of the event was appropriate. | 1 | <input checked="" type="checkbox"/> | 3 | 4 |
| 5. The format was enjoyable. | <input checked="" type="checkbox"/> | 2 | 3 | 4 |
| 6. Did you receive all the information? | 1 | <input checked="" type="checkbox"/> | 3 | 4 |
| 7. The speaker had a good understanding of the topics. | 1 | <input checked="" type="checkbox"/> | 3 | 4 |
| 8. Whether the event worth your time? | <input checked="" type="checkbox"/> | 2 | 3 | 4 |
| 9. The length of the event was appropriate. | <input checked="" type="checkbox"/> | 2 | 3 | 4 |
| 10. Is the facilities were adequate and comfortable? | 1 | <input checked="" type="checkbox"/> | 3 | 4 |

Date: *18/09/2021*



Jeeva.K
Students Signature

PRINCIPAL,
K S R COLLEGE OF ENGINEERING,
(AUTONOMOUS)
TIRUCHENGODE - 637 215.



K.S.R. COLLEGE OF ENGINEERING: TIRUCHENGODE – 637 215

(Autonomous)

(Approved by AICTE, Affiliated to Anna University, Chennai & Accredited by NAAC with 'A' Grade)

DEPARTMENT OF MASTER OF COMPUTER APPLICATIONS

CERTIFICATE FOR PARTICIPATION

This is to certify that Dr. / Mr. / Ms **PAVITHRA S** / Register Number : **2062023**

has Attended the **Value Added Courses on Python Programming Basics to Advanced** at K.S.R. College of Engineering, Tiruchengode, Tamil Nadu, India, from 13.09.2021 to 18.09.2021.

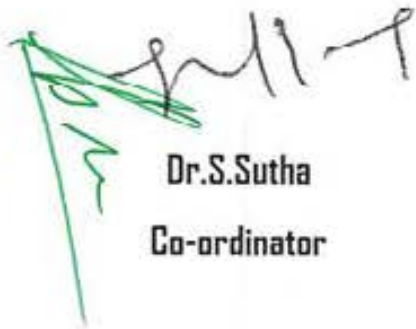

Dr.S.Sutha
Co-ordinator



Dr.P.Anitha
HOD/MCA



Dr.P.Senthilkumar
Principal



K.S.R. COLLEGE OF ENGINEERING: TIRUCHENGODE – 637 215

(Autonomous)

(Approved by AICTE, Affiliated to Anna University, Chennai & Accredited by NAAC with 'A' Grade)

DEPARTMENT OF MASTER OF COMPUTER APPLICATIONS

CERTIFICATE FOR PARTICIPATION

This is to certify that Dr. / Mr. / Ms **LOGAPRIYA S** / Register Number : **2062018**

has Attended the **Value Added Courses on Python Programming Basics to Advanced** at K.S.R. College of Engineering, Tiruchengode, Tamil Nadu, India, from 13.09.2021 to 18.09.2021.

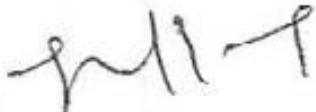
Dr.S.Sutha
Co-ordinator

Dr.P.Anitha
HOD/MCA



Dr.P.Senthilkumar
Principal



K.S.R. COLLEGE OF ENGINEERING: TIRUCHENGODE – 637 215

(Autonomous)

(Approved by AICTE, Affiliated to Anna University, Chennai & Accredited by NAAC with 'A' Grade)

DEPARTMENT OF MASTER OF COMPUTER APPLICATIONS

CERTIFICATE FOR PARTICIPATION

This is to certify that Dr. / Mr. / Ms **ELANGO V R** / Register Number : **2062008**

has Attended the **Value Added Courses on Python Programming Basics to Advanced** at K.S.R. College of Engineering, Tiruchengode, Tamil Nadu, India, from 13.09.2021 to 18.09.2021.

PRINCIPAL
K.S.R. COLLEGE OF ENGINEERING,
(AUTONOMOUS),
TIRUCHENGODE - 637 215.

Dr.S.Sutha
Co-ordinator



Dr.P.Anitha
HOD/MCA

Dr.P.Senthilkumar
Principal



K.S.R. COLLEGE OF ENGINEERING: TIRUCHENGODE – 637 215

(Autonomous)

(Approved by AICTE, Affiliated to Anna University, Chennai & Accredited by NAAC with 'A' Grade)

DEPARTMENT OF MASTER OF COMPUTER APPLICATIONS

CERTIFICATE FOR PARTICIPATION

This is to certify that Dr. / Mr. / Ms **SELVAPOOVARASAN R /** Register Number : **2062025**

has Attended the **Value Added Courses on Python Programming Basics to Advanced** at K.S.R. College of Engineering, Tiruchengode, Tamil Nadu, India, from 13.09.2021 to 18.09.2021.

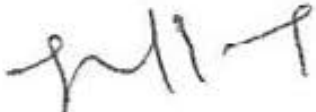

Dr.S.Sutha
Co-ordinator



Dr.P.Anitha
HOD/MCA

Dr.P.Senthilkumar
Principal



K.S.R. COLLEGE OF ENGINEERING: TIRUCHENGODE – 637 215

(Autonomous)

(Approved by AICTE, Affiliated to Anna University, Chennai & Accredited by NAAC with 'A' Grade)

DEPARTMENT OF MASTER OF COMPUTER APPLICATIONS

CERTIFICATE FOR PARTICIPATION

This is to certify that Dr. / Mr. / Ms **DINESHKANNA M** / Register Number : **2062006**

has Attended the **Value Added Courses on Python Programming Basics to Advanced** at K.S.R. College of Engineering, Tiruchengode, Tamil Nadu, India, from **13.09.2021 to 18.09.2021**.

Dr.S.Sutha
Co-ordinator



Dr.P.Anitha
HOD/MCA

Dr.P.Senthilkumar
Principal

K.S.R. COLLEGE OF ENGINEERING
(AUTONOMOUS)
TIRUCHENGODE - 637 215

K.S.R. COLLEGE OF ENGINEERING, TIRUCHENGODE – 637 215
(Autonomous)

DATE: 12-07-2021

TIME: 02.00 p.m.

CIRCULAR

CLASSIFICATION	ROUTINE	IMMEDIATE
ORIGINATOR: PRINCIPAL		CIRCULATED TO: All UG HoDs

Sub.: Accenture Specific Training All UG Third Year Students (2023 Batch) - Reg.

Accenture Specific Training All UG Third Year Students (2023 Batch) has been organized from 15 July 2021 to 09 August 2021 (20 Days). The morning session will be conducted from 09.30 am to 12.30 pm, the afternoon session will be from 01.30 pm to 03.30 pm. So, all the regular classes will be canceled for the training program. Concerned HoDs are requested to instruct their students to be in online mode to them on time and attend the whole training without fail.

Instructions to the Faculty through HoDs

1. All the Department T&P Co-ordinators are requested to monitor the attendance & discipline matters throughout the training program and update the HoDs concerned every day.

Instructions to the Students through Department T&P Co-ordinators & HoDs

1. Discipline
2. Punctuality

If any student not follows the above he/she may not be allowed to proceed further in the process.



PRINCIPAL**Copy to:**

1. All UG HODS for favor of information and circulation among current Third year students and faculty members concerned.
2. All Training & Placement Coordinators.
3. Department Notice board.

EVIDENCE OF COMPLETION

Number of persons not received / seen: - _____

Signature of Originator with date and time: _____

PRINCIPAL
K.S.R. COLLEGE OF ENGINEERING
K.S.R. KALVI NAGAR,
TIRUCHENGODE-637 215

K.S.R. COLLEGE OF ENGINEERING (AUTONOMOUS), TIRUCHENGODE - 637 215

TRAINING AND PLACEMENT

ACCENTURE Training 2023 Batch (15.07.2021 to 09.08.2021)

S.No	Reg No	Name	Branch
1	1912003	GOWTHAM M	CIVIL
2	1912005	KAVINRAJ T	CIVIL
3	1912014	SATHISHKUMAR M	CIVIL
4	1912016	SOHAIL MAQBOOL BHAT	CIVIL
5	1913001	AATHMIGA M	CSE
6	1913002	ABISHEK	CSE
7	1913003	R.ADITYA	CSE
8	1913004	AJAIMARUDHU V	CSE
9	1913007	ARAVINTH. M	CSE
10	1913008	ARULMURUGAN S	CSE
11	1913009	ARUN. AP	CSE
12	1913010	ASIK.A	CSE
13	1913013	R. BHARATH KISHORE	CSE
14	1913014	CHANDRU KANNA R	CSE
15	1913015	DEEPASRI M	CSE
16	1913016	DEEPIKA.V	CSE
17	1913017	M.DHARUN	CSE
18	1913018	DHINESH U	CSE
19	1913019	DHIVYABHARATHI S	CSE
20	1913021	DINESH BABU SM	CSE
21	1913022	DINESH KUMAR M	CSE
22	1915004	ASHOKKUMAR K	ECE
23	1915006	DINESH S	ECE
24	1915007	DINESHKUMAR T	ECE
25	1915008	DIWAHAR S J	ECE
26	1915010	GOWTHAM R	ECE
27	1915011	ILAVARASAN K	ECE
28	1915013	JAGADEEP S	ECE
29	1915015	JAYAPRAKASH. M	ECE
30	1915017	KALIDAS M	ECE
31	1915018	KAMARAJ.J	ECE
32	1915019	KARTHIKA DEVI. K	ECE
33	1915020	KAVIN M	ECE
34	1915021	KAVINESH K	ECE
35	1915022	KAVINMUTHU S	ECE
36	1915024	KIRANRAJ T	ECE
37	1915026	KUMAR.S	ECE
38	1921001	S.M.ABIRAMI	IT
39	1921003	A.AKILA	IT
40	1921004	AKSHAYAA RAAJA SHRI I.T	IT
41	1921005	ANNA LAKSHMI S	IT
42	1921006	ARAVIND B	IT



PRINCIPAL,
K.S.R. COLLEGE OF ENGINEERING
K.S.R. KALVI NAGAR,
TIRUCHENGODE-637 215

43	1921007	R. BALAJI	IT
44	1921008	BHUPESH G	IT
45	1921009	G.S.BLESSING ANTONY	IT
46	1921010	CHITRA S	IT
47	1921011	DEEPAK KUMAR A	IT
48	1921012	DHARUN.B.R.	IT
49	1921015	DHURGADEVI S	IT
50	1921016	DINESH R	IT
51	1921017	S.GOKUL RAJA	IT
52	1921018	GOPALAKRISHNAN S	IT
53	1914001	ABINAYA N	EEE
54	1914007	DINESHWARAN K	EEE
55	1914008	DIVAKAR V	EEE
56	1914010	HARI GOKUL S	EEE
57	1914017	KAARTHIKEYAN S	EEE
58	1914018	KABEENA K J	EEE
59	1914021	KAVIN J R	EEE
60	1914025	KOWSIKPRABU R	EEE
61	1914026	MOHAMMED AL FAHAD	EEE
62	1914028	MOHAN R	EEE
63	1914029	NALAN R	EEE
64	1916013	GNANASELVARAJ P	MECH
65	1916014	GOKUL C	MECH
66	1916020	KAMESH S	MECH
67	1916021	KAVI M	MECH
68	1916053	VELMURUGAN.A	MECH
69	1916502	ARUNKUMAR M	MECH
70	1916505	DHARUNPRASATH.V	MECH
71	1916507	MOHAMED FAIZUL	MECH
72	1916513	KISHORE G	MECH
73	1916514	LOGESHWARAN M	MECH
74	1916515	MAKESKUMAR C	MECH
75	1916516	MANCJ G	MECH

S. [Signature]
15 July 21



[Signature]
PRINCIPAL
K.S.R. COLLEGE OF ENGINEERING
K.S.R. KALVI NAGAR,
TIRUCHENGODE-637 215

KSR College of Engineering (Autonomous), Tiruchengode – 637 215

Training and Placement Cell

Phase – 1 Aptitude, Soft skill and Technical Training Schedule for 2023 Batch

FN	AN
Achievers Tech Talks	Interaction
Resume Building & Presentation	Essay writing & Group Discussion , Activity
SWOT Analysis & Self Introduction	Individual Activity
Permutation and Combination	Probability
Blood Relation, Syllogism	Directions, Coding and Decoding
JDK, JRE, JVM, Structure of Java class	Method overloading , Constructors
Datatypes & Operators, Identifiers	Inheritance , Polymorphism
Polymorphism	Wrapper Class
Exception Handling	String & String Builder

FN Session

9.30 am to 12.30 pm

AN Session

01.30 pm to 04.00 pm

Assessment

04.30 pm to 06.00 pm

*10.46 am – 11.00am – Break

*12.30 pm – 01.30 pm -Lunch Break

* 02.46 pm – 03.00 pm – Break



PRINCIPAL
K.S.R. COLLEGE OF ENGINEERING
K.S.R. KALVI NAGAR,
TIRUCHENGODE-637 215



K.S.R. COLLEGE OF ENGINEERING

KSRCE/QM/8.6/22/PDC

(Autonomous)

TIRUCHENCODE - 637 215. TAMILNADU, INDIA.

Approved by AICTE, New Delhi, Anna University, Chennai & Accredited by NBA and NAAC with 'A' Grade

Professionals Development Cell

Certificate of Participation

This is to certify that Mr./Ms. S. DHIVYA BHARATHI.....
 of Computer Science and Engineering..... department has participated in the
Accenture Specific training - Aptitude and soft skill Development
 programme held at TRAINING AND PLACEMENT CELL, KSRCE.....
 on 15/7/21 to 09/8/21. We wish the student all success.

Date: 09/08/21

[Signature]
Organizer



[Signature]
Co-ordinator



[Signature]
Principal

[Signature]
PRINCIPAL
K.S.R. COLLEGE OF ENGINEERING
K.S.R. KALVI NAGAR
TIRUCHENCODE-637 215



HIGHER EDUCATIONAL CELL





K.S.R. COLLEGE OF ENGINEERING

KSRCE/QM/8.6/22/PDC

(Autonomous)

TIRUCHENGODE - 637 215.TAMILNADU, INDIA.

Approved by AICTE, New Delhi, Anna University, Chennai & Accredited by NBA and NAAC with 'A' Grade

Professionals Development Cell

Certificate of Participation

This is to certify that Mr./Ms. KAMARAJ. J.....
 of Electronics and Communication Engineering..... department has participated in the
Accenture Specific Training - Aptitude and soft skill Development.....
 programme held at TRAINING AND PLACEMENT CELL, KSRCE.....
 on 15/7/21 to 09/8/21. We wish the student all success.

Date: 09/08/2021

S. Gangaiah
 Organizer



G. S. Aravind
 Co-ordinator



[Signature]
 Principal



HIGHER EDUCATIONAL CELL





K.S.R. COLLEGE OF ENGINEERING

KSRCE/QM/8.6/22/PDC

(Autonomous)

TIRUCHENGODE - 637 215. TAMILNADU, INDIA.

Approved by AICTE, New Delhi, Anna University, Chennai & Accredited by NBA and NAAC with 'A' Grade

Professionals Development Cell

Certificate of Participation

This is to certify that Mr./Ms. DINESH:R.....
of INFORMATION TECHNOLOGY..... department has participated in the
Accenture Specific training - Aptitude and Soft Skill development
programme held at TRAINING AND PLACEMENT CELL, KSRCE
on 5/7/21 to 09/8/21. We wish the student all success.

Date: 09/8/2021

S. Anand
Organizer

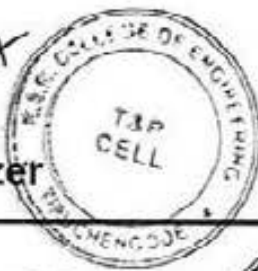

G. S. S.
Co-ordinator



[Signature]
Principal

[Signature]
PRINCIPAL

K.S.R. COLLEGE OF ENGINEERING
K. S. R. KALVI NA
TIRUCHENGODE - 637 215



HIGHER EDUCATIONAL CELL





K.S.R. COLLEGE OF ENGINEERING

KSRCE/QM/8.G/22/PDC

(Autonomous)

TIRUCHENGODE - 637 215 TAMILNADU, INDIA.

Approved by AICTE, New Delhi, Anna University, Chennai & Accredited by NBA and NAAC with 'A' Grade

Professionals Development Cell

Certificate of Participation

This is to certify that Mr./Ms. KAYE . M

of MECHANICAL ENGINEERING department has participated in the

Accenture Specific training - Aptitude and soft skill Development

programme held at TRAINING AND PLACEMENT CELL, KSRCE

on 05/7/21 to 09/8/21 We wish the student all success.

Date: 09/08/2021

G. Srinivas
Organizer



G. Srinivas
Co-ordinator



[Signature]
Principal

[Signature]
PRINCIPAL

K.S.R. COLLEGE OF ENGINEERING
K.S.R. KALVI NAGAR
TIRUCHENGODE-637 215



HIGHER EDUCATIONAL CELL



K.S.R. COLLEGE OF ENGINEERING, TIRUCHENGODE – 637 215
(Autonomous)

DATE: 30.07-2021

TIME: 02.00 p.m.

CIRCULAR

CLASSIFICATION	ROUTINE	IMMEDIATE
ORIGINATOR: PRINCIPAL		CIRCULATED TO: All UG HoDs

Sub.: Technical, Aptitude & Soft Skills Training All UG Second Year Students (2024 Batch) - Reg.

Technical, Aptitude & Soft Skills Training All UG Second Year Students (2024 Batch) has been organized from **02 August 2021 to 13 August 2021 (10 Days)**. The morning session will be conducted from **09.30 am to 12.30 pm**, the afternoon session will be from **01.30 pm to 03.30 pm**. So, all the regular classes will be canceled for the training program. Concerned HoDs are requested to instruct their students to be in online mode to them on time and attend the whole training without fail.

Instructions to the Faculty through HoDs

1. All the Department T&P Co-ordinators are requested to monitor the attendance & discipline matters throughout the training program and update the HoDs concerned every day.

Instructions to the Students through Department T&P Co-ordinators & HoDs

1. Discipline
2. Punctuality

If any student not follows the above he/she may not be allowed to proceed further in the process.



PRINCIPAL

Copy to:

1. All UG HODS for favor of information and circulation among current Second year students and faculty members concerned.
2. All Training & Placement Coordinators.
3. Department Notice board.

EVIDENCE OF COMPLETION

Number of persons not received / seen: - _____

Signature of Originator with date and time: _____



PRINCIPAL
K.S.R. COLLEGE OF ENGINEERING
K.S.R. KALVI NAGAR,
TIRUCHENGODE-637 215

K.S.R. COLLEGE OF ENGINEERING (AUTONOMOUS), TIRUCHENGODE - 637 215

TRAINING AND PLACEMENT

TECHNICAL, APTITUDE & SOFTSKILLS TRAINING 2024 BATCH (02.08.2021 TO 13.08.2021)

S. No	REG NO	NAME	DEPARTMENT
1	2011001	Abishek G	AUTO
2	2011002	Dinesh S	AUTO
3	2011007	Sanjay C	AUTO
4	2011008	Sathishkumar V	AUTO
5	2011010	Vishal K	AUTO
6	2012001	Aravindkumar P	CIVIL
7	2012002	Balasarathi J	CIVIL
8	2012003	Dhanush R	CIVIL
9	2012004	Dheenu K	CIVIL
10	2012005	Dineshkumar R	CIVIL
11	2012006	Dineshkumar S	CIVIL
12	2012007	Gokul S	CIVIL
13	2012008	Gurumoorthi M	CIVIL
14	2012009	Jayasurya G	CIVIL
15	2012010	Kanishk N R	CIVIL
16	2013001	AJAI NARAYANAN S	CSE
17	2013002	AMAL S	CSE
18	2013003	APARNA S	CSE
19	2013004	ARUL PRASANTH N	CSE
20	2013005	ASHOK KUMAR R A	CSE
21	2013006	ASHOKKUMAR K	CSE
22	2013007	ASWINTH A	CSE
23	2013008	BABU SHANKAR PAWAR A	CSE
24	2013009	BARAT VARSAN R S	CSE
25	2013010	BARATH S	CSE
26	2013011	BHARATH G	CSE
27	2013012	BOOBALAN V	CSE
28	2013013	BOOPATHI R	CSE
29	2013014	CHANDRU S	CSE
30	2013015	DEPAKKUMAR N	CSE
31	2013016	DEVADHARSHINI R	CSE
32	2015001	Anandha prakash. R	ECE
33	2015002	S.BALAJI	ECE
34	2015003	DHANRAAJ S	ECE
35	2015004	GIRIDHARAN P	ECE
36	2015005	Gokul k	ECE
37	2015006	GOWTHAM M	ECE
38	2015007	HARIISH R S	ECE
39	2015008	HARISH V	ECE
40	2015009	HEMANTH KUMAR M	ECE
41	2015010	JAICHANDRU S	ECE
42	2015011	Jayaprakash R	ECE
43	2015012	JayaPravinraj.R	ECE
44	2015013	JEEVA R	ECE
45	2015014	JEEVANANTHAN.P	ECE
46	2014001	AJAYKUMAR M	EEE



PRINCIPAL,
K.S.R. COLLEGE OF ENGINEERING
K.S.R. KALVI NAGAR,
TIRUCHENGODE-637 215

47	2014002	AKSHAYAA S	EEE
48	2014003	ARAVINDH R	EEE
49	2014004	ASHOK KUMAR S	EEE
50	2014005	BALASURYA J	EEE
51	2014006	DHAKSHAYANE THARENE MKS	EEE
52	2014007	DHAMODHARAN M	EEE
53	2014008	DHANISH M	EEE
54	2014009	DHANUSH R	EEE
55	2021001	ABISHEK.U	IT
56	2021002	ABISHEK.R.S	IT
57	2021003	BALAJI M	IT
58	2021004	BATSHA. T	IT
59	2021005	BHARATHI.P	IT
60	2021006	BHASKARAPRASATH SK	IT
61	2021007	BHUVANESH.G	IT
62	2021008	DHANUSHYA K	IT
63	2021009	DIVYA K	IT
64	2021011	FARITHA BANU M	IT
65	2021012	GIRIJA V	IT
66	2021014	GOBIKA.C	IT
67	2021015	GOKUL R	IT
68	2016002	BARATHAN K	MECH
69	2016004	GNANAVEL A	MECH
70	2016005	GOKULRAJ R	MECH
71	2016006	GOWTHAM RAJA.P	MECH
72	2016007	HARIHARAN A	MECH
73	2016008	Hariprasanth D	MECH
74	2016009	JAISURYA T	MECH
75	2016010	JAYARAMAN.S	MECH

S. Srinivasan
02 Aug 21



PRINCIPAL
K.S.R. COLLEGE OF ENGINEERING
K.S.R. KALVI NAGAR,
TIRUCHENGODE-637 215

KSR College of Engineering (Autonomous), Tiruchengode – 637 215

Training and Placement Cell

Phase – 1 Aptitude, Soft skill and Technical Training Schedule for 2023 Batch

FN	AN
Achievers Tech Talks	Interaction
Resume Building & Presentation	Essay writing & Group Discussion , Activity
SWOT Analysis & Self Introduction	Individual Activity
Permutation and Combination	Probability
Blood Relation, Syllogism	Directions, Coding and Decoding
JDK, JRE, JVM, Structure of Java class	Method overloading , Constructors
Datatypes & Operators, Identifiers	Inheritance , Polymorphism
Polymorphism	Wrapper Class
Exception Handling	String & String Builder

FN Session

9.30 am to 12.30 pm

AN Session

01.30 pm to 04.00 pm

Assessment

04.30 pm to 06.00 pm

*10.46 am – 11.00am - Break

*12.30 pm – 01.30 pm -Lunch Break

* 02.46 pm – 03.00 pm – Break

S. Srinivasan
02 Aug 21



PRINCIPAL,
K.S.R. COLLEGE OF ENGINEERING
K.S.R. KALVI NAGAR,
TIRUCHENGODE-637 215



KSRCE/QM/8.6/22/PDC

K.S.R. COLLEGE OF ENGINEERING

(Autonomous)

TIRUCHENGODE - 637 215.TAMILNADU, INDIA.

Approved by AICTE, New Delhi, Anna University, Chennai & Accredited by NBA and NAAC with 'A' Grade

Professionals Development Cell

Certificate of Participation

This is to certify that Mr./Ms. JAYASURYA.T.....
 of MECHANICAL ENGINEERING..... department has participated in the
TECHNICAL, APTITUDE & SOFT SKILL TRAINING.....
 programme held at TRAINING AND PLACEMENT CELL, KSRCE.....
 on 2/8/21 to 13/8/21.. We wish the student all success.

Date: 13/8/21

S. Praveen
Organizer

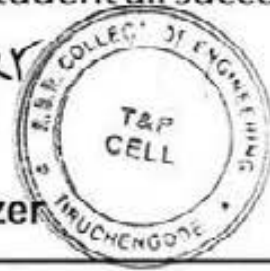

G. S.
Co-ordinator



[Signature]
Principal

[Signature]
PRINCIPAL

K.S.R. COLLEGE OF ENGINEERING
K.S.R. KALVI NAGAR,
TIRUCHENGODE-637 215



HIGHER EDUCATIONAL CELL





K.S.R. COLLEGE OF ENGINEERING

KSRCE/QM/8.G/22/PDC

(Autonomous)

TIRUCHENGODE - 637 215, TAMILNADU, INDIA.

Approved by AICTE, New Delhi, Anna University, Chennai & Accredited by NBA and NAAC with 'A' Grade

Professionals Development Cell

Certificate of Participation

This is to certify that Mr./Ms. BAVAJIM
 of INFORMATION TECHNOLOGY department has participated in the
TECHNICAL, APTITUDE & SOFT SKILL TRAINING
 programme held at TRAINING AND PLACEMENT CELL, KSRCE
 on 02/08/21 to 13/8/21. We wish the student all success.

Date: 13/08/2021

[Signature]
 Organizer

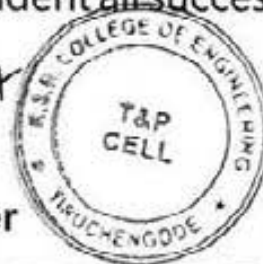

[Signature]
 Co-ordinator



[Signature]
 Principal

[Signature]

PRINCIPAL,
 K.S.R. COLLEGE OF ENGINEERING
 K.S.R. KALVI NAGAR
 TIRUCHENGODE-637 215



HIGHER EDUCATIONAL CELL





K.S.R. COLLEGE OF ENGINEERING

(Autonomous)

TIRUCHENCODE - 637 215. TAMILNADU, INDIA.

Approved by AICTE, New Delhi, Anna University, Chennai & Accredited by NBA and NAAC with 'A' Grade

Professionals Development Cell

KSRCE/QM/8.6/22/PDC

Certificate of Participation

This is to certify that Mr./Ms. S. BALAJI.....
 of ELECTRONICS AND COMMUNICATION ENGINEERING department has participated in the
TECHNICAL, APTITUDE & SOFT SKILL TRAINING.....
 programme held at TRAINING AND PLACEMENT CELL, KSRCE.....
 on 02/08/21 to 13/8/21.. We wish the student all success.

Date: 13/08/2021

S. Srinivas
Organizer



G. Srinivas
Co-ordinator



[Signature]
Principal

[Signature]
PRINCIPAL,
K.S.R. COLLEGE OF ENGINEERING
K.S.R. KAMINAGAR
TIRUCHENCODE-637 215



HIGHER EDUCATIONAL CELL





KSRCE/QM/8.6/22/PDC

K.S.R. COLLEGE OF ENGINEERING

(Autonomous)

TIRUCHENGODE - 637 215. TAMILNADU, INDIA.

Approved by AICTE, New Delhi, Anna University, Chennai & Accredited by NBA and NAAC with 'A' Grade

Professionals Development Cell

Certificate of Participation

This is to certify that Mr./Ms. JAYASURYA . G.....
 of CIVIL ENGINEERING.....department has participated in the
TECHNICAL, APTITUDE & SOFT SKILL TRAINING.....
 programme held at TRAINING AND PLACEMENT CELL, KSRCE.....
 on 02/08/21 to 13/08/21. We wish the student all success.

Date: 13/08/21
 Organizer

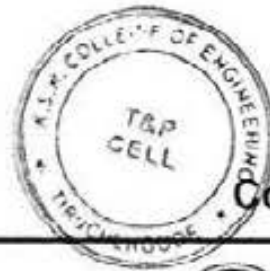

Co-ordinator



Principal

PRINCIPAL
 K.S.R. COLLEGE OF EN
 K.S.R. KALVI NA
 TIRUCHENGODE-



HIGHER EDUCATIONAL CELL



ENGINEERING
R,
215)

K.S.R. COLLEGE OF ENGINEERING, TIRUCHENGODE - 637 215
(Autonomous)

DATE: 20.08.2021

TIME: 02.00 p.m.

CIRCULAR

CLASSIFICATION	ROUTINE	IMMEDIATE
ORIGINATOR: PRINCIPAL		CIRCULATED TO: All UG HoDs

Sub.: Wipro Specific Training All UG Final Year Students (2022 Batch) - Reg.

Wipro Specific Training All UG Final Year Students (2022 Batch) has been organized from 23 August 2021 to 28 August 2021 (6 Days). The morning session will be conducted from 09.30 am to 12.30 pm, the afternoon session will be from 01.30 pm to 03.30 pm. So, all the regular classes will be canceled for the training program. Concerned HoDs are requested to instruct their students to be in physical mode to them on time and attend the whole training without fail.

Instructions to the Faculty through HoDs

1. All the Department T&P Co-ordinators are requested to monitor the attendance & discipline matters throughout the training program and update the HoDs concerned every day.

Instructions to the Students through Department T&P Co-ordinators & HoDs

1. Discipline
2. Punctuality

If any student not follows the above he/she may not be allowed to proceed further in the process.

PRINCIPAL

Copy to:

1. All UG HODS for favor of information and circulation among current final year students and faculty members concerned.
2. All Training & Placement Coordinators.
3. Department Notice board.

EVIDENCE OF COMPLETION

Number of persons not received / seen: - _____

Signature of Originator with date and time: _____



PRINCIPAL
K.S.R. COLLEGE OF ENGINEERING
K.S.R. KALVI NAGAR,
TIRUCHENGODE-637 215

32	1813513	THIRUMOORTHY R	KSRCE	CSE	P	P	P	P	P	P	P	P	P	P	P	P	P	P	P	P	P
33	1813514	VIKASH R	KSRCE	CSE	P	P	P	P	P	P	P	P	P	P	P	P	P	P	P	P	P
34	1816001	ARAVINTHAN M	KSRCE	MECH	P	P	P	P	P	P	P	P	P	P	P	P	P	P	P	P	P
35	1816005	DINESHRAJA V	KSRCE	MECH	P	P	P	P	P	P	P	P	P	P	P	P	P	P	P	P	P
36	1816010	MAHENDRAN K	KSRCE	MECH	P	P	P	P	P	P	P	P	P	P	P	A	A	A	P	P	P
37	1816014	PRASANTH R	KSRCE	MECH	P	P	P	P	P	P	P	P	P	P	P	A	A	A	P	P	P
38	1816016	PUGAZHENTHI D	KSRCE	MECH	P	P	P	P	P	P	P	P	P	P	P	P	P	P	P	P	P
39	1816022	SHRIHAR N S	KSRCE	MECH	P	P	P	P	P	P	A	A	A	P	P	P	A	A	A	A	A
40	1816027	VASANTH R	KSRCE	MECH	P	P	P	P	P	P	P	P	P	P	P	P	P	P	P	P	P
41	1816028	VIGNESH T	KSRCE	MECH	P	P	P	P	P	P	P	P	P	P	P	P	P	P	P	P	P
42	1816029	VISHNU RAM V	KSRCE	MECH	P	P	P	P	P	P	P	P	P	P	P	P	P	P	P	P	P
43	1816503	ARUNKUMAR K	KSRCE	MECH	P	P	P	P	P	P	P	P	P	P	P	P	P	P	P	P	P
44	1816507	DIWAKAR C	KSRCE	MECH	P	P	P	P	P	P	P	P	P	P	P	P	P	P	P	P	P
45	1816015	S PRAVEEN KUMAR	KSRCE	MECH	A	A	A	P	P	P	P	A	A	P	P	P	P	P	P	P	P
46	1816514	HARISH S	KSRCE	MECH	P	P	P	A	A	A	A	A	A	A	A	A	A	A	A	A	A
47	1816519	KALAIYARASAN I R	KSRCE	MECH	A	A	A	P	P	P	P	P	P	P	P	P	P	P	P	P	P
48	1816018	RAJA VIGNESH R	KSRCE	MECH	A	A	A	P	P	P	P	A	A	P	P	P	P	P	P	P	P
49	1816509	GOWTHAM K	KSRCE	MECH	A	A	A	P	P	P	P	P	P	P	P	P	P	P	P	P	P
50	1816506	DINESH K	KSRCE	MECH	A	A	A	P	P	P	P	P	P	P	P	P	P	P	P	P	P
51	1816527	NANDAKUMAR G	KSRCE	MECH	P	P	P	P	P	P	P	P	P	P	P	P	P	P	P	P	P
52	1816529	NAWINES PRAVIN M K	KSRCE	MECH	P	P	P	P	P	P	P	P	A	A	A	A	A	A	A	A	A
53	1816532	PRABHU R	KSRCE	MECH	P	P	P	P	P	P	P	P	P	P	P	P	P	P	P	P	P
54	1816511	HARI PRASAD S	KSRCE	MECH	A	A	A	P	P	P	A	P	P	P	P	P	P	P	P	P	P
55	1816505	DHARANI RAJ R	KSRCE	MECH	A	A	A	P	P	P	P	P	P	P	P	P	P	P	P	P	P
56	1816535	PRASANTH S	KSRCE	MECH	P	P	P	P	P	P	P	P	P	P	P	P	P	P	P	P	P
57	1816537	RAJKUMAR S	KSRCE	MECH	P	P	P	P	P	P	P	P	P	P	P	P	P	P	P	P	P
58	1816540	SANJAI L	KSRCE	MECH	P	P	P	P	P	P	P	P	P	P	P	P	P	P	P	P	P
59	1816528	NAVEEN TPV	KSRCE	MECH	A	A	A	P	P	P	P	P	P	P	P	P	P	P	P	P	P
60	1816546	TAMILARASAN K	KSRCE	MECH	P	P	P	P	P	P	P	P	P	P	P	P	P	P	P	P	P
61	1816521	KARTHICK R	KSRCE	MECH	A	A	A	A	A	A	P	P	P	P	P	P	P	P	P	P	P
62	1816551	VIJAYA KUMAR N	KSRCE	MECH	P	P	P	P	P	P	P	A	A	P	P	P	P	P	P	P	P

S. S. Srinivasan
04 Jan 22
TRAINING OFFICER

28	1814536	VIGNESH	KSRCE	EEE	P	P	P	P	P	P	P	P	P	P	P	P	P	P	P	P	P	P	P
29	1814008	JAYAPAL	KSRCE	EEE	P	P	P	P	P	P	P	P	P	P	P	P	P	P	P	P	P	P	P
30	1814504	BHARATHKUMAR	KSRCE	EEE	P	P	P	P	P	P	P	P	P	P	P	P	P	P	P	P	P	P	P
31	1814531	SHIBINJOSWA	KSRCE	EEE	P	P	P	A	A	A	P	P	P	P	P	P	P	P	P	P	P	P	P
32	1814009	KARANSANTH	KSRCE	EEE	A	A	A	P	P	P	P	P	P	P	P	P	P	P	P	P	P	P	P
33	1814016	SRIDHAR	KSRCE	EEE	A	A	A	P	P	P	P	P	P	P	P	P	P	P	P	P	P	P	P
34	1814530	SHARMILA	KSRCE	EEE	P	P	P	P	P	P	P	P	P	P	P	P	P	P	P	P	P	P	P
35	1814525	RANJITH	KSRCE	EEE	P	P	P	P	P	P	P	P	P	P	P	P	P	P	P	P	P	P	P
36	1814518	NARAYANAN	KSRCE	EEE	P	P	P	P	P	P	P	P	P	P	P	P	P	P	P	P	P	P	P
37	1821004	GOKUL RAJ M	KSRCE	IT	P	P	P	P	P	P	P	P	P	P	P	P	P	P	P	P	P	P	P
38	1821010	LOGESWARAN M	KSRCE	IT	P	P	P	P	P	P	P	P	P	P	P	P	P	P	P	P	P	P	P
39	1821011	MANGAYARKARASI. S	KSRCC	IT	P	P	P	P	P	P	P	P	P	P	P	P	P	P	P	P	P	P	P
40	1821013	NAVEEN KUMAR J	KSRCE	IT	P	P	P	P	P	P	P	P	P	P	P	P	P	P	P	P	P	P	P
41	1821014	V.NAVETHA	KSRCE	IT	P	P	P	P	P	P	P	P	P	A	P	P	P	P	P	P	P	P	P
42	1821018	PRIVADHARSHINI T.R	KSRCE	IT	P	P	P	P	P	P	P	P	P	P	P	P	P	P	P	P	P	P	P
43	1821020	RUPASRI V	KSRCE	IT	P	P	P	P	P	P	P	P	P	P	P	P	P	P	P	P	P	P	P
44	1821021	SABAREESH S	KSRCE	IT	P	P	P	P	P	P	P	P	P	P	P	P	P	P	P	P	P	P	P
45	1821023	E.SRISARAN	KSRCE	IT	P	P	P	A	A	A	P	P	P	P	P	P	P	P	P	P	P	P	P
46	1821025	TAMILSELVAN.P	KSRCE	IT	P	P	P	P	P	P	P	P	P	P	P	P	P	P	P	P	P	P	P
47	1811002	DANUSH KUMAR R	KSRCE	AUTO	P	P	P	P	P	P	P	P	P	A	P	P	P	P	P	P	P	P	P
48	1811006	KARAN.S	KSRCE	AUTO	P	P	P	P	P	P	P	P	P	P	P	P	P	P	P	P	P	P	P
49	1811009	NIRMAL.G	KSRCE	AUTO	P	P	P	P	P	P	P	P	P	P	P	P	P	P	P	P	P	P	P
50	1811524	VINITH J	KSRCE	AUTO	A	A	A	P	P	P	P	P	P	P	P	P	P	P	P	P	P	P	P
51	1811511	SAKTHIVEL.L	KSRCE	AUTO	P	P	P	P	P	P	P	P	A	P	A	A	A	A	A	P	P	P	P
52	1811520	VASANTHA KUMAR.E	KSRCE	AUTO	P	P	P	P	P	P	P	P	P	P	P	P	P	P	P	P	P	P	P
53	1811521	VIGNESH.J	KSRCE	AUTO	P	P	P	P	P	P	P	P	P	P	P	P	P	P	P	P	P	P	P
54	1812012	RAVI VARMA SV	KSRCE	CIVIL	P	P	P	P	P	P	P	P	P	P	P	P	P	P	P	P	P	P	P

S. Manoj K
TRAINING OFFICER



[Signature]
PRINCIPAL
K.S.R. COLLEGE OF ENGINEERING
K.S.R. KALVI NAGAR,
TIRUCHENGODE-637 215

KSR College of Engineering (Autonomous), Tiruchengode – 637 215

Training and Placement Cell

Phase – 1 Aptitude, Soft skill and Technical Training Schedule for 2023 Batch

FN	AN
Achievers Tech Talks	Interaction
Resume Building & Presentation	Essay writing & Group Discussion , Activity
SWOT Analysis & Self Introduction	Individual Activity
Permutation and Combination	Probability
Blood Relation, Syllogism	Directions, Coding and Decoding
JDK, JRE, JVM, Structure of Java class	Method overloading , Constructors
Datatypes & Operators, Identifiers	Inheritance , Polymorphism
Polymorphism	Wrapper Class
Exception Handling	String & String Builder

FN Session

9.30 am to 12.30 pm

AN Session

01.30 pm to 04.00 pm

Assessment

04.30 pm to 06.00 pm

*10.46 am – 11.00am - Break

*12.30 pm – 01.30 pm -Lunch Break

* 02.46 pm – 03.00 pm – Break

S. Gnanapriya
23 Aug 21



PRINCIPAL
K.S.R. COLLEGE OF ENGINEERING
K.S.R. KALVI NAGAR,
TIRUCHENGODE-637 215



KSRCE/QM/8.G/22/PDC

K.S.R. COLLEGE OF ENGINEERING

(Autonomous)

TIRUCHENGODE 637 215.TAMILNADU, INDIA.

Approved by AICTE, New Delhi, Anna University, Chennai & Accredited by NBA and NAAC with 'A' Grade

Professionals Development Cell

Certificate of Participation

This is to certify that Mr./Ms. MONISHA.S.....
of ELECTRONICS AND COMMUNICATION ENGINEERING department has participated in the
WIPRO SPECIFIC TRAINING.....
programme held at TRAINING AND PLACEMENT CELL, KSRCE.....
on 23/8/21 to 28/8/21. We wish the student all success.

Date: 28/08/21

[Signature]
Organizer

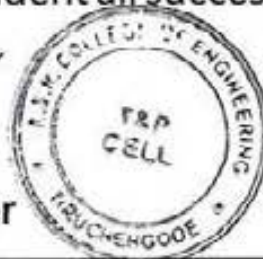

[Signature]
Co-ordinator



[Signature]
Principal
K.S.R. COLLEGE OF ENGINEERING
K.S.R. KALVI NAGAR
TIRUCHENGODE-637 215



HIGHER EDUCATIONAL CELL





K.S.R. COLLEGE OF ENGINEERING

KSRCE/QM/8.6/22/PDC

(Autonomous)

TIRUCHENGODE - 637 215. TAMIL NADU, INDIA.

Approved by AICTE, New Delhi, Anna University, Chennai & Accredited by NBA and NAAC with 'A' Grade

Professionals Development Cell

Certificate of Participation

This is to certify that Mr./Ms. VIJANESH.T
 of MECHANICAL ENGINEERING department has participated in the
WIPRO SPECIFIC TRAINING
 programme held at TRAINING AND PLACEMENT CELL, KSRCE
 on 23/8/21 to 24/8/21. We wish the student all success.

Date: 28/08/2021

[Signature]
 Organizer



[Signature]
 Co-ordinator



[Signature]
 Principal

PRINCIPAL
 K.S.R. COLLEGE OF ENGINEERING
 K.S.R. KALVI NAGAR
 TIRUCHENGODE-637 215



HIGHER EDUCATIONAL CELL





KSRCE/QM/8.6/22/PDC

K.S.R. COLLEGE OF ENGINEERING

(Autonomous)

TIRUCHENGODE 637 215.TAMILNADU, INDIA.

Approved by AICTE, New Delhi, Anna University, Chennai & Accredited by NBA and NAAC with 'A' Grade

Professionals Development Cell

Certificate of Participation

This is to certify that Mr./~~Ms~~ HARISH.S.....
of MECHANICAL ENGINEERING.....department has participated in the
WIPRO SPECIFIC TRAINING.....
programme held at TRAINING AND PLACEMENT CELL, KSRCE.....
on 23/8/21 to 28/8/21.. We wish the student all success.

Date: 28/08/21

[Signature]
Organizer



[Signature]
Co-ordinator



[Signature]
Principal
PRINCIPAL
COLLEGE OF ENGINEERING
K.S.R. KALVI NAGAR,
TIRUCHENGODE-637 215



HIGHER EDUCATIONAL CELL





K.S.R. COLLEGE OF ENGINEERING

KSRCE/QM/8.6/22/PDC

(Autonomous)

TIRUCHENGODE - 637 215 TAMILNADU, INDIA.

Approved by AICTE, New Delhi, Anna University, Chennai & Accredited by NBA and NAAC with 'A' Grade

Professionals Development Cell

Certificate of Participation

This is to certify that Mr./~~Ms~~ S.Y. IILAMUKILAN.....
 of COMPUTER..... SCIENCE..... AND..... ENGINEERING..... department has participated in the
WIPRO..... SPECIFIC..... TRAINING.....
 programme held at TRAINING AND PLACEMENT CELL, KSRCE.....
 on 28/08/21 to 28/8/21. We wish the student all success.

Date: 28/08/2021  Organizer

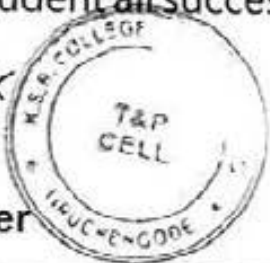

 Co-ordinator



 Principal

PRINCIPAL
K.S.R. COLLEGE OF ENGINEERING
K.S.R. KALVINAGAR
TIRUCHENGODE-637 215



HIGHER EDUCATIONAL CELL



K.S.R. COLLEGE OF ENGINEERING, TIRUCHENGODE – 637 215
(Autonomous)

DATE: 02-09-2021

TIME: 03.00 p.m.

CIRCULAR

CLASSIFICATION	ROUTINE	IMMEDIATE
ORIGINATOR: PRINCIPAL		CIRCULATED TO: MBA and MCA HoDs

Sub.: Training Program for Final Year Students of MBA and MCA (2022 Batch) - Reg.

Aptitude Training Program for all MBA and MCA Final Year (2022 Batch) has been organized from 06th September 2021 to 16th September 2021 (08 Working Days). The morning session will be conducted from 09.30 am to 12.30 pm, the afternoon session will be from 01.30 pm to 04.00 pm. So, all the regular classes will be canceled for the training program. Concerned HoDs are requested to instruct their students to be in physical mode to them on time and attend the whole training without fail.

Instructions to the Faculty through HoDs

1. MBA and MCA T&P Co-ordinators are requested to monitor the attendance & discipline matters throughout the training program and update the progress to HoDs concerned every day.

Instructions to the Students through Department T&P Co-ordinators & HoDs

1. Discipline
2. Punctuality

If any student not follows the above he/she may not be allowed to proceed further in the process.

TRAINING & PLACEMENT OFFICER
K.S.R. COLLEGE OF ENGINEERING
TIRUCHENGODE - 637 215.

[Signature]
PRINCIPAL

Copy to:

1. MBA and MCA HoDs for favor of information and circulation among current Final year students and faculty members concerned.
2. All Training & Placement Coordinators.
3. Department Notice board.

EVIDENCE OF COMPLETION

Number of persons not received / seen: _____

Signature of Originator with date and time: _____

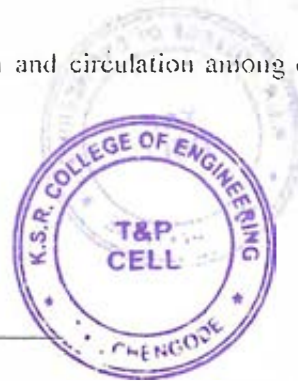

[Signature]
PRINCIPAL

K.S.R. COLLEGE OF ENGINEERING
K.S.R. KALVI NAGAR,
TIRUCHENGODE-637 215

1/2

Training and Placement Cell

Aptitude Training Schedule for MBA and MCA

Date	Session 1 09.30am to 10.45am	Session 2 11.00am to 12.30pm	Session 3 01.30pm to 02.45pm	Session 4 03.00pm to 04.00pm
06.09.2021	Numbers System		Blood Relations, Coding Decoding	Assessment and Discussion
07.09.2021	Percentage Profit and Loss		Syllogism	Assessment and Discussion
08.09.2021	Ratio Proportions and Partnership		Directions	Assessment and Discussion
09.09.2021	Time and Work, Data Interpretation		Arrangements and Puzzles	Assessment and Discussion
13.09.2021	Time Speed Distance, Boats and Streams		Ranking and Ordering, Inequalities	Assessment and Discussion
14.09.2021	Permutation and Combination, Probability		Input and Output	Assessment and Discussion
15.09.2021	Average, Mixture and Alligation		Non Verbal Reasoning	Assessment and Discussion
16.09.2021	Verbal Ability		Verbal Ability	Verbal Ability

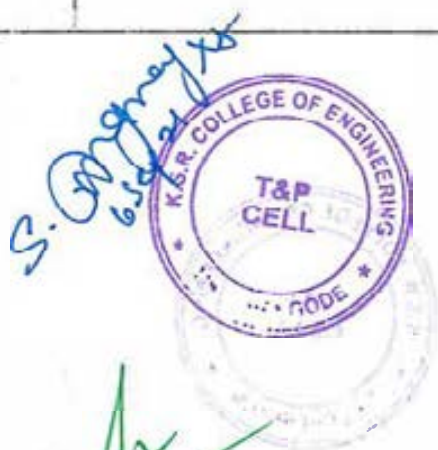

PRINCIPAL
K.S.R. COLLEGE OF ENGINEERING
K.S.R. KALVI NAGAR,
TIRUCHENGODE-637 215

2/2

K.S.R. COLLEGE OF ENGINEERING(Autonomous), TIRUCHENGODUR - 637 215
TRAINING & PLACEMENT CELL
MBA, MCA FINAL YEAR STUDENTS 2021-2022 BATCH
APTITUDE INTERNAL TRAINING (06.09.2021 to 14.09.2021)

S.No	Reg No	Name	College	Branch	06.09.21		TEST	08.09.21		TEST	09.09.21		TEST	13.09.21		TEST	14.09.21		TEST	
					FN	AN	15 MARKS	FN	AN	15 MARKS	FN	AN	20 MARKS	FN	AN	20 MARKS	FN	AN	20 MARKS	
1	2061002	AKSHAYARAGHAVIE S	KSRCE	MBA	P	P	10	P	P	11	P	P	14		P	12	P	A	A	
2	2061003	ANASH MOHAMED A	KSRCE	MBA	P	P	6	P	P	5	P	P	7		P	6	P	P	5	
3	2061004	ANITHA A	KSRCE	MBA	A	A	A	A	A	A	A	A	A	A	A	A	A	A	A	
4	2061005	APPASALI E	KSRCE	MBA	P	P	2	P	P	9	P	A	A	A	A	A	P	P	9	
5	2061006	ARIHARAN K	KSRCE	MBA	A	A	8	P	P	4	P	P	11	P	P	A	A	A	A	
6	2061007	ASWANTH M T	KSRCE	MBA	A	A	A	A	A	A	A	A	A	A	A	A	A	A	A	
7	2061009	DHARMESHWARAN S	KSRCE	MBA	P	P	A	A	A	A	A	A	A	A	A	A	P	P	8	
8	2061010	DILEEP KUMAR S	KSRCE	MBA	P	P	9	P	P	7	P	P	11	P	P	10	P	P	10	
9	2061011	JANCY M	KSRCE	MBA	P	P	7	P	P	9	P	P	9	P	P	11	P	P	14	
10	2061013	KAVIYA S	KSRCE	MBA	P	P	4	P	P	9	P	P	12	P	P	11	P	P	13	
11	2061014	KOWSALYA M	KSRCE	MBA	P	P	4	P	P	5	P	A	A	A	P	11	P	P	14	
12	2061015	MITHRA T	KSRCE	MBA	P	P	7	P	P	4	P	P	12	P	P	11	P	P	13	
13	2061016	PARANIARASU A V P	KSRCE	MBA	P	P	5	P	P	4	P	P	6	P	P	A	A	A	A	
14	2061017	PAVITHRA V	KSRCE	MBA	P	P	7	P	P	5	P	P	P	A	P	11	P	P	14	
15	2061018	ROJA SUJATHA S B	KSRCE	MBA	A	A	A	A	A	A	A	A	A	A	A	A	A	A	A	
16	2061019	RUPESH V R	KSRCE	MBA	P	P	3	P	P	11	P	P	5	P	P	12	P	P	12	
17	2061020	RUTHRAPRIYAN P	KSRCE	MBA	A	A	A	A	A	A	A	A	A	A	A	A	P	P	9	
18	2061021	SATHISWARAN R	KSRCE	MBA	P	P	8	P	P	11	P	P	13	P	P	13	P	P	12	
19	2061022	SHAIJU S	KSRCE	MBA	P	P	9	P	P	8	P	P	10	A	A	A	P	P	11	
20	2061023	SILUVAIJERIN A	KSRCE	MBA	P	P	A	P	P	A	P	P	10	A	A	A	A	A	A	
21	2061024	SIVARANJANI B	KSRCE	MBA	P	P	6	P	P	11	P	P	11	P	P	12	P	P	14	
22	2061025	SUBASH S	KSRCE	MBA	P	P	3	P	P	3	P	P	11	P	P	10	P	P	10	
23	2061027	SUJITH A	KSRCE	MBA	P	P	6	P	P	9	P	P	9	P	P	10	P	P	11	
24	2061028	SUPRAJA G	KSRCE	MBA	A	A	7	P	P	10	P	P	12	P	P	11	P	P	13	
25	2061029	TAMILARASAN M A	KSRCE	MBA	P	P	4	P	P	5	P	P	10	P	P	A	A	A	A	
26	2061030	VINOTH KUMAR M	KSRCE	MBA	P	P	8	P	P	3	P	P	8	P	P	9	P	P	11	
TOTAL					26	26		26	26		26		26	26		26	26			
PRESENT					20	21		21	21		20		18	18		19	19			
ABSENT					6	5		5	5		6		8	8		7	7			
PLACEMENT CO ORDINATOR SIGN																				
HOD SIGN																				
TRAINING & PLACEMENT																				
TRAINING OFFICER																				
PRINCIPAL																				

PRINCIPAL
 K.S.R. COLLEGE OF ENGINEERING
 K.S.R. KALVI NAGAR,
 TIRUCHENGODUR.637 215

K.S.R. COLLEGE OF ENGINEERING(Autonomous), TIRUCHENGODE - 637 215
TRAINING & PLACEMENT CELL

MBA, MCA FINAL YEAR STUDENTS 2021-2022 BATCH

APTITUDE INTERNAL TRAINING (06.09.2021 to 14.09.2021)

S.No	Reg No	Name	College	Branch	06.09.21		TEST	08.09.21		TEST	09.09.21		TEST	13.09.21		TEST	14.09.21		TEST
					FN	AN	15 MARKS	FN	AN	15 MARKS	FN	AN	20 MARKS	FN	AN	20 MARKS	FN	AN	20 MARKS
27	2062001	AIITH P	KSRCE	MCA	P	P	2	P	P	7	P	P	7	P	P	8	P	P	10
28	2062003	ASWINI S	KSRCE	MCA	P	P	6	P	P	3	P	P	9	P	P	9	P	P	8
29	2062006	DINESHKANNA M	KSRCE	MCA	A	A	A	A	A	A	A	A	A	P	P	7	P	P	13
30	2062007	DIVYAPRABHA N	KSRCE	MCA	P	P	8	P	P	9	P	P	10	P	P	8	P	P	10
31	2062008	ELANGO V R	KSRCE	MCA	P	P	A	A	A	A	A	A	A	A	A	A	A	A	A
32	2062010	GOKUL A	KSRCE	MCA	P	P	5	P	P	10	P	P	10	P	P	9	P	P	11
33	2062014	KARTHIKEYAN G	KSRCE	MCA	A	A	A	A	A	A	A	A	A	A	A	A	A	A	A
34	2062015	KAVINKUMAR M	KSRCE	MCA	P	P	5	P	P	9	A	A	A	A	A	A	A	A	A
35	2062017	LAVANYA A	KSRCE	MCA	P	P	3	P	P	10	P	P	10	P	P	8	P	P	12
36	2062018	LOGAPRIYA S	KSRCE	MCA	P	P	6	P	P	11	P	P	14	P	P	6	P	P	8
37	2062020	MATHAN B	KSRCE	MCA	P	P	8	P	P	6	P	P	9	P	P	10	P	P	8
38	2062021	MATHIYALAGAN	KSRCE	MCA	P	P	9	P	P	6	P	P	13	P	P	8	P	P	10
39	2062022	MOHAN S	KSRCE	MCA	P	P	A	A	A	A	A	A	A	A	A	A	A	A	A
40	2062026	SETHUPATHI S V	KSRCE	MCA	A	A	A	A	A	A	A	A	A	A	A	A	A	A	A
41	2062027	SHALINI A	KSRCE	MCA	P	P	2	P	P	7	P	P	7	P	P	9	P	P	12
42	2062028	SHALINI J	KSRCE	MCA	P	P	A	A	A	A	A	A	A	A	A	A	A	A	A
43	2062012	JAYASHREE D	KSRCE	MCA	A	A	A	P	P	A	P	P	11	P	P	11	P	P	10
44	2062005	DHARANI M	KSRCE	MCA	A	A	6	P	P	6	P	P	8	P	P	11	P	P	9
45	2062011	ISWARYA V	KSRCE	MCA	A	A	5	P	P	4	P	P	10	P	P	10	P	P	11
46	2062009	FARDOSH A	KSRCE	MCA	A	A	A	A	A	A	A	A	A	A	A	A	P	P	9
TOTAL					20	20		20	20		20	20		20	20		20	20	
PRESENT					13	13		13	13		12	12		13	13		14	14	
ABSENT					6	6		6	6		7	7		6	6		6	6	
PLACEMENT CO ORDINATOR SIGN																			
HOD SIGN																			
TRAINING & PLACEMENT																			
TRAINING OFFICER																			
PRINCIPAL																			

PRINCIPAL
 K.S.R. COLLEGE OF ENGINEERING
 K.S.R. KALVI NAGAR,
 TIRUCHENGODE - 637 215.

TRAINING & PLACEMENT OFFICER
 K.S.R. COLLEGE OF ENGINEERING
 TIRUCHENGODE - 637 215.

K.S.R. COLLEGE OF ENGINEERING (AUTONOMOUS), TIRUCHENGODE - 637215

TRAINING AND PLACEMENT CELL

STUDENT'S FEEDBACK FORM FOR TRAINING

Name of the Student: A. FARDOSH

Reg. No.: 2062009

Date: 14/09/202

Year/ Sem : III

Dept. : MCA

S. No.	Rate the Following	Trainer 1	Trainer 2	Trainer 3	Trainer 4	Trainer 5
	Trainer Name	<u>Giridharan</u>				
1	Content & Structure of the Training	<u>5</u>				
2	Clarity of Instructions	<u>4</u>				
3	Delivery of the Content	<u>5</u>				
4	Method of Delivery (Use of Aids)	<u>5</u>				
5	Handouts & Manuals	<u>5</u>				
6	Trainer's Communication	<u>4</u>				
7	Assistance from the Trainer	<u>5</u>				
8	"Hands on" Practice	<u>5</u>				
9	Attainment of Objective	<u>4</u>				
10	Time Management	<u>5</u>				
	Total	<u>42</u>				
How could this training be improved? (Quality/Quantity of the information presented, type of illustrations used).						
Mention the additional Training requirement if any.						

Rate the Trainers: Poor - 1, Fair - 2, Good - 3, Very Good - 4, Excellent - 5

Practical Aptitude

Name of the Training Programme:

Giridharan
Name of the Training Agency:

A. Fardosh
Signature of the Student



[Signature]
PRINCIPAL
K.S.R. COLLEGE OF ENGINEERING
K.S.R. KALVI NAGAR,
TIRUCHENGODE-637 215.

K.S.R. COLLEGE OF ENGINEERING (AUTONOMOUS), TIRUCHENGODE – 637215

TRAINING AND PLACEMENT CELL

STUDENT'S FEEDBACK FORM FOR TRAINING

Name of the Student: DWYAPRABHA Reg. No.: 2062007 Date: 14/09/2021

Year/ Sem : II - MCA Dept. : MCA

S. No.	Rate the Following	Trainer 1	Trainer 2	Trainer 3	Trainer 4	Trainer 5
	Trainer Name	Giridharan				
1	Content & Structure of the Training	3				
2	Clarity of Instructions	2				
3	Delivery of the Content	3				
4	Method of Delivery (Use of Aids)	3				
5	Handouts & Manuals	4				
6	Trainer's Communication	4				
7	Assistance from the Trainer	3				
8	"Hands on" Practice	4				
9	Attainment of Objective	3				
10	Time Management	3				
	Total	32				
How could this training be improved? (Quality/Quantity of the information presented, type of illustrations used).						
Mention the additional Training requirement if any.						

Rate the Trainers: Poor – 1, Fair – 2, Good – 3, Very Good – 4, Excellent – 5

Internal Aptitude class

Name of the Training Programme:

Giridharan

Name of the Training Agency:

Dwyaprabha

Signature of the Student



PRINCIPAL
K.S.R. COLLEGE OF ENGINEERING
K.S.R. KALVI NAGAR,
TIRUCHENGODE-637 215

K.S.R. COLLEGE OF ENGINEERING (AUTONOMOUS), TIRUCHENGODE – 637215

TRAINING AND PLACEMENT CELL

STUDENT'S FEEDBACK FORM FOR TRAINING

Name of the Student: DILEEPKUMAR.S

Reg. No.: 2061010

Date: 14/9/2021

Year/ Sem : 2 Year / 3 Semester

Dept. : MBA

S. No.	Rate the Following	Trainer 1	Trainer 2	Trainer 3	Trainer 4	Trainer 5
	Trainer Name	<u>GIRSDHARANA</u>				
1	Content & Structure of the Training	5				
2	Clarity of Instructions	5				
3	Delivery of the Content	5				
4	Method of Delivery (Use of Aids)	4				
5	Handouts & Manuals	3				
6	Trainer's Communication	5				
7	Assistance from the Trainer	5				
8	"Hands on" Practice	5				
9	Attainment of Objective	4				
10	Time Management	5				
	Total	<u>46</u>				
How could this training be improved? (Quality/Quantity of the information presented, type of illustrations used).		<u>Quality of the Information presented</u> <u>Type of illustrations used</u> <u>Less Tension</u>				
Mention the additional Training requirement if any.						

Rate the Trainers: Poor – 1, Fair – 2, Good – 3, Very Good – 4, Excellent – 5

Name of the Training Programme:

Name of the Training Agency:

S. Deep Kumar

Signature of the Student



[Signature]
 PRINCIPAL
 K.S.R. COLLEGE OF ENGINEERING
 K.S.R. KALVI NAGAR,
 TIRUCHENGODE-637 215

K.S.R. COLLEGE OF ENGINEERING (AUTONOMOUS), TIRUCHENGODE – 637215

TRAINING AND PLACEMENT CELL

STUDENT'S FEEDBACK FORM FOR TRAINING

Name of the Student:

Reg. No.: 2061019

Date: 13/09/21

Year/ Sem : IInd = 3rd Sem.

Dept. : MBA

S. No.	Rate the Following	Trainer 1	Trainer 2	Trainer 3	Trainer 4	Trainer 5
	Trainer Name	Giridharan.				
1	Content & Structure of the Training	4				
2	Clarity of Instructions	5				
3	Delivery of the Content	5				
4	Method of Delivery (Use of Aids)	5				
5	Handouts & Manuals	4				
6	Trainer's Communication	4				
7	Assistance from the Trainer	4				
8	"Hands on" Practice	5				
9	Attainment of Objective	4				
10	Time Management	5				
	Total	15				
How could this training be improved? (Quality/Quantity of the information presented, type of illustrations used).		Because of some students don't treat all as same. because some are really willing to learn kpti.				
Mention the additional Training requirement if any.						

Rate the Trainers: Poor – 1, Fair – 2, Good – 3, Very Good – 4, Excellent – 5

Name of the Training Programme: Placement

Name of the Training Agency:

Signature of the Student



PRINCIPAL
K.S.R. COLLEGE OF ENGINEERING
K.S.R. KALVI NAGAR,
TIRUCHENGODE-637 215

K.S.R. COLLEGE OF ENGINEERING (AUTONOMOUS), TIRUCHENGODE - 637215

TRAINING AND PLACEMENT CELL

STUDENT'S FEEDBACK FORM FOR TRAINING

Name of the Student: **KOWSALYA.M**

Reg. No.: **206104**

Date: **12.09.2021**

Year/ Sem : **II - 3rd Sem**

Dept. : **MBA**

S. No.	Rate the Following	Trainer 1	Trainer 2	Trainer 3	Trainer 4	Trainer 5
	Trainer Name	GIRIDHARAN				
1	Content & Structure of the Training	3				
2	Clarity of Instructions	4				
3	Delivery of the Content	4				
4	Method of Delivery (Use of Aids)	4				
5	Handouts & Manuals	5				
6	Trainer's Communication	4				
7	Assistance from the Trainer	3				
8	"Hands on" Practice	3				
9	Attainment of Objective	4				
10	Time Management	3				
	Total	37				
How could this training be improved? (Quality/Quantity of the information presented, type of illustrations used).						
Mention the additional Training requirement if any.						

Rate the Trainers: Poor - 1, Fair - 2, Good - 3, Very Good - 4, Excellent - 5

Name of the Training Programme:

Name of the Training Agency:



M. Kowsalya
Signature of the Student

[Signature]
PRINCIPAL
K.S.R. COLLEGE OF ENGINEERING
K.S.R. KALVI NAGAR,
TIRUCHENGODE-637 215

K.S.R. COLLEGE OF ENGINEERING (AUTONOMOUS), TIRUCHENGODE – 637215

TRAINING AND PLACEMENT CELL

STUDENT'S FEEDBACK FORM FOR TRAINING

Name of the Student: *B. Sivarajani*

Reg. No.: *2061024*

Date: *14.9.2022*

Year/ Sem

: *IInd Year / IIIrd Sem*

Dept. : *MBA*

S. No.	Rate the Following	Trainer 1	Trainer 2	Trainer 3	Trainer 4	Trainer 5
	Trainer Name	<i>Geethakumar</i>				
1	Content & Structure of the Training	<i>3</i>				
2	Clarity of Instructions	<i>3</i>				
3	Delivery of the Content	<i>3</i>				
4	Method of Delivery (Use of Aids)	<i>3</i>				
5	Handouts & Manuals	<i>3</i>				
6	Trainer's Communication	<i>4</i>				
7	Assistance from the Trainer					
8	"Hands on" Practice	<i>3</i>				
9	Attainment of Objective	<i>5</i>				
10	Time Management	<i>4</i>				
	Total	<i>29</i>				
How could this training be improved? (Quality/Quantity of the information presented, type of illustrations used).						
Mention the additional Training requirement if any.						

Rate the Trainers: Poor – 1, Fair – 2, Good – 3, Very Good – 4, Excellent – 5

Name of the Training Programme:

Internal Aptitude Training.

Name of the Training Agency:

B. Bijan
Signature of the Student



[Signature]
PRINCIPAL
K.S.R. COLLEGE OF ENGINEERING
K.S.R. KALVI NAGAR,
TIRUCHENGODE-637 215

K.S.R. COLLEGE OF ENGINEERING (AUTONOMOUS), TIRUCHENGODE – 637215

TRAINING AND PLACEMENT CELL

STUDENT'S FEEDBACK FORM FOR TRAINING

Name of the Student: M. Dineshkannan

Reg. No.: 2062006

Date: 14.09.2021

Year/ Sem : II - year

Dept. : MCA

S. No.	Rate the Following	Trainer 1	Trainer 2	Trainer 3	Trainer 4	Trainer 5
	Trainer Name	<u>G. Sridharan</u>				
1	Content & Structure of the Training	<u>5</u>				
2	Clarity of Instructions	<u>4</u>				
3	Delivery of the Content	<u>4</u>				
4	Method of Delivery (Use of Aids)	<u>4</u>				
5	Handouts & Manuals	<u>5</u>				
6	Trainer's Communication	<u>4</u>				
7	Assistance from the Trainer	<u>4</u>				
8	"Hands on" Practice	<u>4</u>				
9	Attainment of Objective	<u>4</u>				
10	Time Management	<u>4</u>				
	Total	<u>42</u>				
How could this training be improved? (Quality/Quantity of the information presented, type of illustrations used).						
Mention the additional Training requirement if any.						

Rate the Trainers: Poor – 1, Fair – 2, Good – 3, Very Good – 4, Excellent – 5

Name of the Training Programme:

Internal Aptitude training

Name of the Training Agency:

G. Sridharan

[Signature]
Signature of the Student



[Signature]
PRINCIPAL
K.S.R. COLLEGE OF ENGINEERING
K.S.R. KALVI NAGAR,
TIRUCHENGODE-637 215

Phase – 1 Aptitude Training Schedule for 2023 Batch

Date	FN	AN
06.09.2021	Number System	Blood Relation, Coding and Decoding
07.09.2021	Percentage, profit & loss	Syllogism
08.09.2021	Ratio Proportions & Partnership	Directions
09.09.2021	Time & Work, Data Interpretation	Arrangements & puzzles
13.09.2021	Time Speed and Distance , Boats & Streams	Ranking & Ordering, Inequalities
14.09.2021	Permutation and Combination, Probability	Input & Output
15.09.2021	Average, Mixture & Alligation	Non Verbal Reasoning
16.09.2021	Verbal Ability	Verbal Ability

FN Session

9.30 am to 12.30 pm

AN Session

01.30 pm to 04.00 pm

Assessment

04.30 pm to 06.00 pm

*10.46 am – 11.00am - Break

*12.30 pm – 01.30 pm - Lunch Break

*02.46 pm – 03.00 pm – Break



PRINCIPAL
K.S.R. COLLEGE OF ENGINEERING
K.S.R. KALVI NAGAR,
TIRUCHENGODE-637 2157



KSRCE/QM/8.6/22/PDC

K.S.R. COLLEGE OF ENGINEERING

(Autonomous)

TIRUCHENGODE - 637 215.TAMILNADU, INDIA.

Approved by AICTE, New Delhi, Anna University, Chennai & Accredited by NBA and NAAC with 'A' Grade

Professionals Development Cell

Certificate of Participation

This is to certify that Mr./Ms. FARDOSH.A
of MASTER OF COMPUTER APPLICATIONS department has participated in the
"APTITUDE TRAINING PROGRAMME"
programme held at TRAINING AND PLACEMENT CELL" - KSRCE
on 06/09/21 to 16/09/21. We wish the student all success.

Date: 16/09/2021

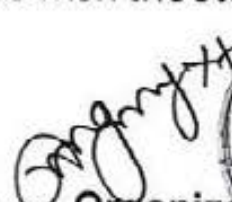
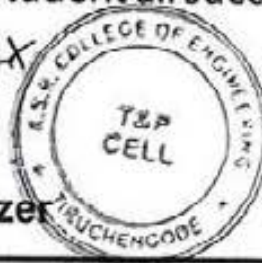
Organizer 

Co-ordinator 

Principal 
K.S.R. COLLEGE OF ENGINEERING
K.S.R. KALVI NAGAR,
TIRUCHENGODE-637 215



HIGHER EDUCATIONAL CELL





K.S.R. COLLEGE OF ENGINEERING

KSRCE/QM/8.6/22/PDC

(Autonomous)

TIRUCHENGODE 637 215. TAMILNADU, INDIA.

Approved by AICTE, New Delhi, Anna University, Chennai & Accredited by NBA and NAAC with 'A' Grade

Professionals Development Cell

Certificate of Participation

This is to certify that Mr./Ms. ELANCO, V.R.
 of MASTER OF COMPUTER APPLICATIONS department has participated in the
"APTITUDE TRAINING PROGRAMME"
 programme held at TRAINING AND PLACEMENT CELL - KSRCE
 on 06/09/21 to 16/09/21. We wish the student all success.

Date: 16/09/2021

[Signature]
Organizer

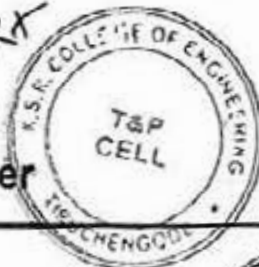

[Signature]
Co-ordinator



[Signature]
Principal

[Signature]
PRINCIPAL



HIGHER EDUCATIONAL CELL



K.S.R. COLLEGE OF ENGINEERING
R. KALVI NAGAR,
TIRUCHENGODE-637 215



K.S.R. COLLEGE OF ENGINEERING

KSRCE/QM/8.6/22/PDC

(Autonomous)

TIRUCHENGODE - 637 215, TAMILNADU, INDIA.

Approved by AICTE, New Delhi, Anna University, Chennai & Accredited by NBA and NAAC with 'A' Grade

Professionals Development Cell

Certificate of Participation

This is to certify that Mr./Ms. SUJITH. A.....
 of MASTER OF BUSINESS ADMINISTRATION..... department has participated in the
'APTITUDE TRAINING PROGRAMME'.....
 programme held at TRAINING AND PLACEMENT CELL - KSRCE.....
 on 06/09/21 to 16/09/21... We wish the student all success.

Date: 16/09/2021

S. Ganesh
 Organizer

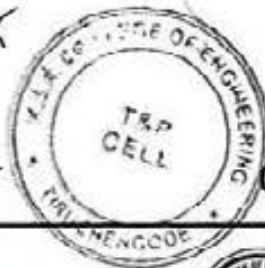

G. F.
 Co-ordinator



[Signature]
 Principal

PRINCIPAL
 K.S.R. COLLEGE OF ENGINEERING
 K.S.R. KALVI NAGAR
 TIRUCHENGODE - 637 215



HIGHER EDUCATIONAL CELL





K.S.R. COLLEGE OF ENGINEERING

(Autonomous)

TIRUCHENGODE - 637 215. TAMILNADU, INDIA.

Approved by AICTE, New Delhi, Anna University, Chennai & Accredited by NBA and NAAC with 'A' Grade

Professionals Development Cell

Certificate of Participation

This is to certify that Mr./Ms. PAVITHRA . V
 of MASTER OF BUSINESS ADMINISTRATION department has participated in the
"APTITUDE TRAINING PROGRAMME"
 programme held at TRAINING AND PLACEMENT CELL - KSRCE
 on 06/09/21 to 16/09/21. We wish the student all success.

Date: 16/09/21

[Signature]
 Organizer

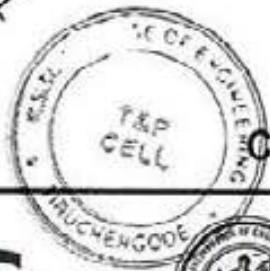

[Signature]
 Co-ordinator



[Signature]
 PRINCIPAL
 K.S.R. COLLEGE OF ENGINEERING
 K.S.R. KALVI NAGAR,
 TIRUCHENGODE-637 215



HIGHER EDUCATIONAL CELL



2021 - 2022
7

KSRCE/QM/5.5.3/01/2020-21/TP15

K.S.R. COLLEGE OF ENGINEERING, TIRUCHENGODE – 637 215
(Autonomous)

DATE: 03.09.2021

TIME: 02.00 p.m.

CIRCULAR

CLASSIFICATION	ROUTINE	IMMEDIATE
ORIGINATOR: PRINCIPAL		CIRCULATED TO: CSE, ECE, EEE & IT HoDs

Sub.: TCS NINJA Training CSE, ECE, EEE& IT Final Year Students (2022 Batch) - Reg.

TCS NINJA Training CSE, ECE, EEE& IT Final Year Students (2022 Batch) has been organized from 07 September 2021 to 10 September 2021 (4 Days). The morning session will be conducted from 09.30 am to 12.30 pm, the afternoon session will be from 01.30 pm to 03.30 pm. So, all the regular classes will be canceled for the training program. Concerned HoDs are requested to instruct their students to be in physical mode to them on time and attend the whole training without fail.

Instructions to the Faculty through HoDs

1. All the Department T&P Co-ordinators are requested to monitor the attendance & discipline matters throughout the training program and update the HoDs concerned every day.

Instructions to the Students through Department T&P Co-ordinators & HoDs

1. Discipline
2. Punctuality

If any student not follows the above he/she may not be allowed to proceed further in the process.

PRINCIPAL

Copy to:

1. CSE, ECE, EEE & IT HODS for favor of information and circulation among current final year students and faculty members concerned.
2. All Training & Placement Coordinators.
3. Department Notice board.

EVIDENCE OF COMPLETION

Number of persons not received / seen: - _____

Signature of Originator with date and time: _____



PRINCIPAL
K.S.R. COLLEGE OF ENGINEERING
K.S.R. KALVI NAGAR,
TIRUCHENGODE-637 215

K.S.R. COLLEGE OF ENGINEERING (AUTONOMOUS), TIRUCHENGODE - 637 215

TRAINING AND PLACEMENT

TCS NINJA TRAINING FINAL YEAR STUDENTS 2021-2022 BATCH

S. No	REG NO	NAME	BRANCH	DATE	07.09.2021		08.09.2021		09.09.2021		10.09.2021	
				SESSION BATCH	FN	AN	FN	AN	FN	AN	FN	AN
1	1813001	ARTHI P	CSE		1	1	1	1	1	1	1	1
2	1813006	BALAMURUGAN C	CSE		1	1	1	1	1	1	1	1
3	1813007	BHARATH G	CSE		a	a	1	1	1	1	1	1
4	1813008	BHARATH R	CSE		1	1	1	1	1	1	1	1
5	1813010	BOOBALAN N	CSE		a	a	1	1	1	1	1	1
6	1813011	BOOPALAN K	CSE		1	1	1	1	1	1	1	1
7	1813012	DAVANIKA R	CSE		1	1	1	1	1	1	1	1
8	1813013	DEEPIKA E	CSE		1	1	1	1	1	1	1	1
9	1813018	GOBINATH S	CSE		a	a	1	1	1	1	1	1
10	1813023	GURU VIGNESH K	CSE		1	1	1	1	1	1	1	1
11	1813025	HARI KRISHNAN A	CSE		1	1	1	1	1	1	1	1
12	1813026	HARINI K R	CSE		1	1	1	1	1	1	1	1
13	1813028	HARITHA B	CSE		1	1						
14	1813029	ILAMUKILAN S V	CSE		1	1	a	a	1	1	1	1
15	1813030	JAYANTHI M	CSE		1	1	1	1	1	1	1	1
16	1813032	KALAIPRIYA N	CSE		1	1	1	1	1	1	1	1
17	1813033	KANNAN P	CSE		1	1	1	1	1	1	1	1
18	1813040	MANIKANDAN T	CSE		1	1	1	1	1	1	1	1
19	1813042	MOHAMMED AZARUDEEN J	CSE		1	1	1	1	1	1	1	1
20	1813047	NAVEENKUMAR M	CSE		1	1	1	1	1	1	1	1
21	1813051	PERIYASAMY A	CSE		1	1	1	1	1	1	1	1
22	1813055	PRIYADHARSHINI S	CSE		1	1	1	1	1	1	1	1
23	1813060	ROSHAN B	CSE		1	1	1	1	1	1	1	1
24	1813061	SANJAY K	CSE		1	1		1	1	1	1	1
25	1813062	SANTHIYA S	CSE		1	1		1	1	1	1	1

26	1813064	SARAN KISHORE A S	CSE	✓	✓	✓	✓	✓	✓	✓	✓	✓
27	1813067	SASMITHA K	CSE	✓	✓	✓	✓	✓	✓	✓	✓	✓
28	1813069	SRINIVASAN B	CSE	✓	✓	✓	✓	✓	✓	✓	✓	✓
29	1813070	SUDHARSHAN B	CSE	✓	✓	✓	✓	✓	✓	✓	✓	✓
30	1813073	THANARAJ G	CSE	✓	✓	✓	✓	✓	✓	✓	✓	✓
31	1813078	VERJIN SANTHIYA G	CSE	✓	✓	✓	✓	✓	✓	✓	✓	✓
32	1813082	YOKASH S	CSE	✓	✓	✓	✓	✓	✓	✓	✓	✓
33	1813083	YUGENTH P	CSE	✓	✓	✓	✓	✓	✓	✓	✓	✓
34	1813513	THIRUMOORTHY R	CSE	✓	✓	✓	✓	✓	✓	✓	✓	✓
35	1813514	VIKASH R	CSE	✓	✓	✓	✓	✓	✓	✓	✓	✓
36	1815003	DHAYANITHI G	ECE	✓	✓	✓	✓	✓	✓	✓	✓	✓
37	1815004	GANGAA SRI.S	ECE	✓	✓	✓	✓	✓	✓	✓	✓	✓
38	1815005	GOPIKA.V	ECE	✓	✓	✓	✓	✓	✓	✓	✓	✓
39	1815006	JONISHA.M	ECE	✓	9	9	9	9	✓	✓	✓	✓
40	1815009	KAVIYA A	ECE	✓	✓	✓	✓	✓	✓	✓	✓	✓
41	1815010	KEERTHANA.S	ECE	✓	✓	✓	✓	✓	✓	✓	✓	✓
42	1815011	MONISHA.S	ECE	✓	✓	✓	✓	✓	✓	✓	✓	✓
43	1815012	NARMADHA.E	ECE	✓	✓	✓	✓	✓	✓	✓	✓	✓
44	1815013	NIVETHA P	ECE	✓	✓	✓	✓	✓	✓	✓	✓	✓
45	1815015	POOJA PRIYADHARSHINI R	ECE	✓	✓	✓	✓	✓	✓	✓	✓	✓
46	1815017	SARAN. M	ECE	✓	✓	✓	9	9	✓	✓	✓	✓
47	1815018	SARAVANAN V	ECE	✓	✓	✓	✓	✓	✓	✓	✓	✓
48	1815019	SELVAKUMAR.S	ECE	✓	✓	✓	✓	✓	✓	✓	✓	✓
49	1815024	SUDHARSAN.V.T	ECE	✓	✓	✓	✓	✓	✓	✓	✓	✓
50	1815029	VUJAYALAKSHMI G	ECE	✓	9	9	✓	✓	✓	✓	✓	✓
51	1815501	BALAMURALIDHARAN.K.R	ECE	2	✓	✓	✓	✓	✓	✓	✓	✓
52	1815513	SIVA ABHISHEK.R	ECE	2	✓	✓	✓	✓	✓	✓	✓	✓
53	1814003	DEEPANRAJ	EEE	2	✓	✓	✓	✓	✓	✓	✓	✓
54	1814008	JAYAPAL	EEE	2	✓	✓	✓	✓	✓	✓	✓	✓
55	1814013	SABAREESWARAN	EEE	2	9	9	✓	✓	✓	✓	✓	✓
56	1814015	SIVARAMAN	EEE	2	✓	✓	✓	✓	✓	✓	✓	✓
57	1814504	BHARATHKUMAR	EEE	2	9	9	9	9	✓	✓	✓	✓

58	1814513	JEGANATHAN	EEE	2	9	9	9	9	9	9	9	9
59	1814530	SHARMILA	EEE	2	1	1	1	1	1	1	1	1
60	1814531	SHIBINJOSWA	EEE	2	9	9	9	9	9	9	9	9
61	1814535	VIGNESH	EEE	2	1	1	1	1	1	1	1	1
62	1814536	VIGNESH	EEE	2	9	9	9	9	9	9	9	9
63	1814537	VIVEKA	EEE	2	9	9	9	9	9	9	9	9
64	1821004	GOKUL RAJ M	IT	2	9	9	9	9	1	1	1	1
65	1821010	LOGESWARAN M	IT	2	9	9	9	9	1	1	1	1
66	1821011	MANGAYARKARASI. S	IT	2	9	9	9	9	1	1	1	1
67	1821013	NAVEEN KUMAR J	IT	2	9	9	9	9	1	1	1	1
68	1821014	V.NAVETHA	IT	2	1	1	1	1	1	1	1	1
69	1821018	PRIYADHARSHINI.T.R	IT	2	1	1	1	1	1	1	1	1
70	1821020	RUPASRI V	IT	2	1	1	1	1	1	1	1	1
71	1821021	SABAREESH S	IT	2	1	1	1	1	1	1	1	1
72	1821023	E.SRISARAN	IT	2	1	1	1	1	1	1	1	1
73	1821025	TAMILSELVAN.P	IT	2	9	9	1	1	1	1	1	1

S. [Signature] 04 Jan 22
 TRAINING OFFICER



[Signature]
 PRINCIPAL
 K.S.R. COLLEGE OF ENGINEERING
 K.S.R. KALVI NAGAR,
 TIRUCHENGODE-637 215

KSR College of Engineering (Autonomous), Tiruchengode – 637 215

Training and Placement Cell

Phase – 1 Aptitude, Soft skill and Technical Training Schedule for 2023 Batch

FN	AN
Achievers Tech Talks	Interaction
Resume Building & Presentation	Essay writing & Group Discussion , Activity
SWOT Analysis & Self Introduction	Individual Activity
Permutation and Combination	Probability
Blood Relation, Syllogism	Directions, Coding and Decoding
JDK, JRE, JVM, Structure of Java class	Method overloading , Constructors
Datatypes & Operators, Identifiers	Inheritance , Polymorphism
Polymorphism	Wrapper Class
Exception Handling	String & String Builder

FN Session

9.30 am to 12.30 pm

AN Session

01.30 pm to 04.00 pm

Assessment

04.30 pm to 06.00 pm

*10.46 am – 11.00am - Break

*12.30 pm – 01.30 pm -Lunch Break

* 02.46 pm – 03.00 pm – Break



PRINCIPAL
K.S.R. COLLEGE OF ENGINEERING
K.S.R. KALVI NAGAR,
TIRUCHENGODE-637 215



K.S.R. COLLEGE OF ENGINEERING

KSRCE/QM/8.G/22/PDC

(Autonomous)

TIRUCHENGODE - 637 215, TAMILNADU, INDIA.

Approved by AICTE, New Delhi, Anna University, Chennai & Accredited by NBA and NAAC with 'A' Grade

Professionals Development Cell

Certificate of Participation

This is to certify that Mr./Ms. SAISARAN.S
 of INFORMATION TECHNOLOGY department has participated in the
"TCS NINJA TRAINING"
 programme held at TRAINING AND PLACEMENT CELL - KSRCE
 on 02/09/2021 to 10/09/2021. We wish the student all success.

Date: 10/09/2021

S. Ganesh
 Organizer

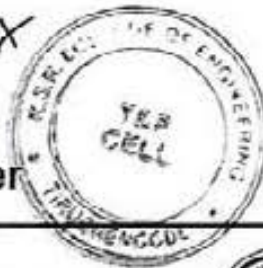

G. F. S.
 Co-ordinator



[Signature]
 Principal
 K.S.R. COLLEGE OF ENGINEERING
 K.S.R. KALVI NAGAR
 TIRUCHENGODE-637 215



HIGHER EDUCATIONAL CELL





K.S.R. COLLEGE OF ENGINEERING

(Autonomous)

TIRUCHENGODE - 637 215. TAMILNADU, INDIA.

Approved by AICTE, New Delhi, Anna University, Chennai & Accredited by NBA and NAAC with 'A' Grade

Professionals Development Cell

Certificate of Participation

This is to certify that Mr./Ms. SHARMILA.S
 of ELECTRICAL AND ELECTRONIC ENGINEERING department has participated in the
TCS NNJA TRAINING
 programme held at TRAINING AND PLACEMENT CELL - KSRCE
 on 7/9/21 to 10/9/21. We wish the student all success.

Date: 10/09/2021

[Signature]
Organizer



[Signature]
Co-ordinator



[Signature]
Principal
K.S.R. COLLEGE OF ENGINEERING
K.S.R. KALVI NAGAR
TIRUCHENGODE-637 215



HIGHER EDUCATIONAL CELL





K.S.R. COLLEGE OF ENGINEERING

KSRCE/QM/8.6/22/PDC

(Autonomous)

TIRUCHENGODE - 637 215 TAMILNADU, INDIA.

Approved by AICTE, New Delhi, Anna University, Chennai & Accredited by NBA and NAAC with 'A' Grade

Professionals Development Cell

Certificate of Participation

This is to certify that Mr./Ms. GANUASRI S
of ELECTRONICS AND COMMUNICATION ENGINEERING department has participated in the
'TCS NINJA TRAINING'
programme held at TRAINING AND PLACEMENT CELL - KSRCE
on 7/09/21 to 10/09/21. We wish the student all success.

Date: 10/09/2021

S. Ganu
Organizer

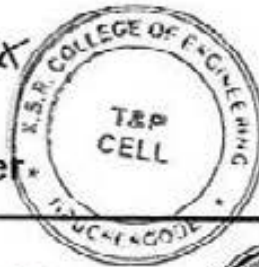

G. S.
Co-ordinator



[Signature]
Principal
K.S.R. COLLEGE OF ENGINEERING
K.S.R. KALVI NAGAR,
TIRUCHENGODE-637 215



HIGHER EDUCATIONAL CELL





K.S.R. COLLEGE OF ENGINEERING

KSRCE/QM/8.6/22/PDC

(Autonomous)

TIRUCHENGODE - 637 215 TAMILNADU, INDIA

Approved by AICTE, New Delhi, Anna University, Chennai & Accredited by NBA and NAAC with 'A' Grade

Professionals Development Cell

Certificate of Participation

This is to certify that Mr./Ms. BHARATH G......
 of COMPUTER SCIENCE AND ENGINEERING..... department has participated in the
'TCS NINJA TRAINING'.....
 programme held at TRAINING AND PLACEMENT CELL - KSRCE.....
 on 7/09/21 to 10/9/21... We wish the student all success.

Date: 10/09/21

S. Sangmy
 Organizer

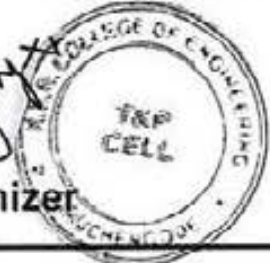

G. S. P
 Co-ordinator



[Signature]
 Principal

[Signature]
 PRINCIPAL
 K.S.R. COLLEGE OF ENGINEERING
 K.S.R. KALVI NAGAR
 TIRUCHENGODE-637 215



HIGHER EDUCATIONAL CELL



2021-2022

18

KSRCE/QM/5.5.3/01/2020-21/TP17

K.S.R. COLLEGE OF ENGINEERING, TIRUCHENGODE – 637 215
(Autonomous)

DATE: 19.09.2021

TIME: 02.00 p.m.

CIRCULAR

CLASSIFICATION	ROUTINE	IMMEDIATE
ORIGINATOR: PRINCIPAL		CIRCULATED TO: CSE, ECE, EEE, IT & MCA HoDs

Sub.: Caggemini Specific Training CSE, ECE, EEE, IT & MCA Final Year Students (2022 Batch) - Reg.

Caggemini Specific Training CSE, ECE, EEE, IT & MCA Final Year Students (2022 Batch) has been organized from 21 September 2021 to 26 September 2021 (6 Days). The morning session will be conducted from 09.30 am to 12.30 pm, the afternoon session will be from 01.30 pm to 03.30 pm. So, all the regular classes will be canceled for the training program. Concerned HoDs are requested to instruct their students to be in physical mode to them on time and attend the whole training without fail.

Instructions to the Faculty through HoDs

1. All the Department T&P Co-ordinators are requested to monitor the attendance & discipline matters throughout the training program and update the HoDs concerned every day.

Instructions to the Students through Department T&P Co-ordinators & HoDs

1. Discipline
2. Punctuality

If any student not follows the above he/she may not be allowed to proceed further in the process.



PRINCIPAL

Copy to:

1. CSE, ECE, EEE, IT & MCA HODS for favor of information and circulation among current final year students and faculty members concerned.
2. All Training & Placement Coordinators.
3. Department Notice board.

EVIDENCE OF COMPLETION

Number of persons not received / seen: - _____

Signature of Originator with date and time: _____



PRINCIPAL
K.S.R. COLLEGE OF ENGINEERING
K.S.R. KALVI NAGAR,
TIRUCHENGODE-637 215

K.S.R COLLEGE OF ENGINEERING, TIRUCHENGODE - 637 215

(Autonomous)

Capgemini Specific Training for 2022 Batch

Contents of the Training

S.NO	DATE	TOPICS
1.	21.09.2021 & 22.09.2021	Aptitude <ul style="list-style-type: none">• Number System• Percentage• Ratio Proportion• Time, Speed & Distance• Blood Relation• Permutation & Combination• Average• Profit & Loss• Problems on Ages• Time & Work
2.	23.09.2021	Verbal, Gamification & English Communication Skills
3.	24.09.2021 to 26.09.2021	<ul style="list-style-type: none">• Java coding Practice• Technical MCQ<ul style="list-style-type: none">✓ Data structures and Algorithms✓ OOP's concept

S. Gnanajayam
21 Sep 21



PRINCIPAL
K.S.R. COLLEGE OF ENGINEERING
K.S.R. KALVI NAGAR,
TIRUCHENGODE-637 215

K.S.R EDUCATIONAL INSTITUTIONS,TIRUCHENGODE - 637215

Central Placement Cell

Capgemini Specific Training (21.09.2021 to 26.09.2021) Batch 6 (Hall No : 307)

S. NO	REG.NO	NAME	COLLEGE	BRANCH	21.09.2021			22.09.2021			23.09.2021			24.09.2021			25.09.2021			26.09.2021		
					FN	AN	Test	FN	AN	Test	FN	AN	Test	FN	AN	Test	FN	AN	Test	FN	AN	Test
1	2062007	DIVYAPRABHA NAGARAJ	KSRCE	MCA	P	P	P	P	P	P	P	P	P	P	P	P	P	P	P	P	P	P
2	2062008	V.R ELANGO	KSRCE	MCA	P	P	P	A	A	A	P	P	P	P	P	P	P	P	P	A	A	A
3	2062013	JEEVA K	KSRCE	MCA	P	P	A	A	A	P	P	P	P	A	A	A	P	P	P	A	A	A
4	2062010	A GOKUL	KSRCE	MCA	P	P	P	P	P	P	P	P	P	P	P	P	P	P	P	P	P	P
5	2062028	SHALINI J	KSRCE	MCA	A	A	P	A	A	A	A	A	A	A	A	A	A	A	A	A	-A	A
6	2062016	KRISHNAN S	KSRCE	MCA	P	P	P	A	A	A	P	P	P	P	P	P	P	P	P	A	A	A
7	2062026	SETHUPATHI S V	KSRCE	MCA	A	A	P	A	A	A	A	A	A	P	P	P	P	P	P	A	A	A
8	2062017	LAVANYA A ARUCHAMY	KSRCE	MCA	P	P	P	P	P	P	P	P	P	P	P	P	P	P	P	A	A	A
9	2062003	ASWINI S	KSRCE	MCA	P	P	P	P	P	P	P	P	P	P	P	P	P	P	P	P	P	P
10	2062002	AKSHAYA K R	KSRCE	MCA	P	P	P	P	P	P	P	P	P	P	P	P	P	P	P	P	P	P
11	2062009	FARDOSH A	KSRCE	MCA	P	P	P	P	P	P	P	P	P	P	P	P	P	P	P	P	P	P
12	2062014	KARTHIKEYAN G	KSRCE	MCA	A	A	A	A	A	A	P	P	P	P	P	P	A	A	A	A	A	A
13	2062004	BAKYA N	KSRCE	MCA	P	P	P	A	A	A	P	P	P	P	P	P	P	P	P	P	P	P
14	2062022	MOHAN S	KSRCE	MCA	A	A	P	A	A	A	P	P	P	P	P	P	A	A	A	A	A	A
15	2062018	LOGAPRIYA S	KSRCE	MCA	P	P	P	P	P	P	P	P	P	P	P	P	P	P	P	P	P	P
16	2062029	SHANMUGAPRIYA M	KSRCE	MCA	P	P	P	P	P	P	P	P	P	P	P	P	A	A	A	A	A	A
17	2062021	S MATHIYALAGAN	KSRCE	MCA	P	P	P	P	P	P	P	P	P	P	P	P	P	P	P	P	P	P
18	2062031	THILAGAVATHI CHETHAMBARAM	KSRCE	MCA	P	P	P	P	P	P	P	P	P	P	P	P	P	P	P	P	P	P
19	2062023	PAVITHRA S	KSRCE	MCA	P	P	P	P	P	P	P	P	P	P	P	P	P	P	P	P	P	P
20	2062030	SUBATHRA THANGARAJ	KSRCE	MCA	P	P	P	P	P	P	P	P	P	P	P	P	P	P	P	P	P	P
21	2062011	V.ISWARYA	KSRCE	MCA	P	P	P	P	P	P	P	P	P	P	P	P	P	P	P	P	P	P
22	2062006	DINESHKANNA M	KSRCE	MCA	P	P	P	P	P	P	P	P	P	P	P	P	P	P	P	P	P	P
23	2062027	SHALINI A	KSRCE	MCA	P	P	P	P	P	P	P	P	P	P	P	P	P	P	P	P	P	P
24	2062001	AJITH P	KSRCE	MCA	P	P	P	P	P	P	P	P	P	P	P	P	P	P	P	P	P	P
25	2062033	VIGNESH T	KSRCE	MCA	A	A	A	A	A	A	P	P	P	P	P	P	P	P	P	A	A	A
26	2062012	JAYA SHREE D	KSRCE	MCA	P	P	P	P	P	P	P	P	P	P	P	P	P	P	P	A	A	A

61	1813030	JAYANTHI M	KSRCE	CSE	P	P	P	P	P	P	P	P	P	P	P	P	P	P	P	P	P	P
62	1813029	ILLAMUKILAN S V	KSRCE	CSE	A	A	P	P	P	P	P	P	P	P	P	P	P	P	P	P	P	P
63	1813514	VIKASH RAJAVEL	KSRCE	CSE	P	P	P	P	P	P	P	P	P	P	P	P	P	P	P	P	P	P

S. *[Signature]*
04 Jan 22
 TRAINING OFFICER



[Signature]
 PRINCIPAL
 K.S.R. COLLEGE OF ENGINEERING
 K.S.R. KALVI NAGAR,
 TIRUCHENGODE-637 215

KSR College of Engineering (Autonomous), Tiruchengode – 637 215

Training and Placement Cell

Phase – 1 Aptitude, Soft skill and Technical Training Schedule for 2023 Batch

FN	AN
Achievers Tech Talks	Interaction
Resume Building & Presentation	Essay writing & Group Discussion , Activity
SWOT Analysis & Self Introduction	Individual Activity
Permutation and Combination	Probability
Blood Relation, Syllogism	Directions, Coding and Decoding
JDK, JRE, JVM, Structure of Java class	Method overloading , Constructors
Datatypes & Operators, Identifiers	Inheritance , Polymorphism
Polymorphism	Wrapper Class
Exception Handling	String & String Builder

FN Session

9.30 am to 12.30 pm

AN Session

01.30 pm to 04.00 pm

Assessment

04.30 pm to 06.00 pm

*10.46 am – 11.00am - Break

*12.30 pm – 01.30 pm -Lunch Break

*02.46 pm – 03.00 pm – Break

S. Aranganathan
21 Sep 21



PRINCIPAL
K.S.R. COLLEGE OF ENGINEERING
K.S.R. KALVI NAGAR,
(TIRUCHENGODE-637 215)



KSRCE/QM/8.6/22/PDC

K.S.R. COLLEGE OF ENGINEERING

(Autonomous)

TIRUCHENGODE - 637 215, TAMILNADU, INDIA.

Approved by AICTE, New Delhi, Anna University, Chennai & Accredited by NBA and NAAC with 'A' Grade

Professionals Development Cell

Certificate of Participation

This is to certify that Mr./Ms. NIVETHA.V.....
of INFORMATION TECHNOLOGY..... department has participated in the
CAPGEMINI SPECIFIC TRAINING.....
programme held at TRAINING AND PLACEMENT CELL - KSRCE.....
on 21/9/21 to 26/9/21... We wish the student all success.

Date: 26/09/21

[Signature]
Organizer



[Signature]
Co-ordinator



[Signature]
Principal
K.S.R. COLLEGE OF ENGINEERING
K.S.R. KALVI NAGAR
TIRUCHENGODE-637 215



HIGHER EDUCATIONAL CELL





K.S.R. COLLEGE OF ENGINEERING

KSRCE/QM/8.6/22/PDC

(Autonomous)

TIRUCHENGODE - 637 215.TAMILNADU, INDIA.

Approved by AICTE, New Delhi, Anna University, Chennai & Accredited by NBA and NAAC with 'A' Grade

Professionals Development Cell

Certificate of Participation

This is to certify that Mr./Ms. SARAN.M
of ELECTRONIC AND COMMUNICATION ENGINEERING department has participated in the
CAPTEMINI SPECIFIC TRAINING
programme held at TRAINING AND PLACEMENT CELL - KSRCE
on 21/9/21 to 26/9/21. We wish the student all success.

Date: 26/09/2021

Gangayy
Organizer



G. F. S.
Co-ordinator



[Signature]
Principal

K.S.R. COLLEGE OF ENGINEERING
K.S.R. KALVI NAGAR
TIRUCHENGODE-637 215



HIGHER
EDUCATIONAL
CELL





K.S.R. COLLEGE OF ENGINEERING

KSRCE/QM/8.G/22/PDC

(Autonomous)

TIRUCHENGODE - 637 215 TAMILNADU, INDIA.

Approved by AICTE, New Delhi, Anna University, Chennai & Accredited by NBA and NAAC with 'A' Grade

Professionals Development Cell

Certificate of Participation

This is to certify that Mr./Ms. GOPIKA.V.....
 of ELECTRONICS AND COMMUNICATION ENGINEERING department has participated in the
CAP CEMINI 1 SPECIFIC TRAINING.....
 programme held at TRAINING AND PLACEMENT CELL - KSRCE.....
 on 21/06/21 to 26/09/21. We wish the student all success.

Date: 26/09/2021

S. Ganesh
Organizer

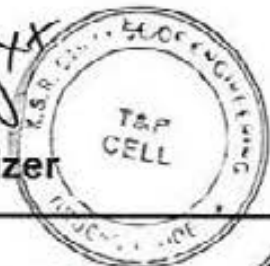

G. S.
Co-ordinator



h
Principal
K.S.R. COLLEGE OF ENGINEERING
K.S.R. KALVI NAGAR
TIRUCHENGODE - 637 215



HIGHER EDUCATIONAL CELL





K.S.R. COLLEGE OF ENGINEERING

KSRCE/QM/8.6/22/PDC

(Autonomous)

TIRUCHENGODE - 637 215 TAMIL NADU, INDIA

Approved by AICTE, New Delhi, Anna University, Chennai & Accredited by NBA and NAAC with 'A' Grade

Professionals Development Cell

Certificate of Participation

This is to certify that Mr./Ms. VIVEKAS.....
of ELECTRICAL AND ELECTRONIC ENGINEERING department has participated in the
CAPCEMINI SPECIFIC TRAINING
programme held at TRAINING AND PLACEMENT CELL - KSRCE
on 21/9/21 to 26/9/21 We wish the student all success.

Date: 26/09/2021

[Signature]
Organizer

[Signature]
Co-ordinator

[Signature]
Principal

PRINCIPAL
K.S.R. COLLEGE OF ENGINEERING
K.S.R. KALVI NAGAR
TIRUCHENGODE-637 215



HIGHER EDUCATIONAL CELL



2021-2022

(10)

KSRCE/QM/5.5.3/01/2021-22/TP12

K.S.R. COLLEGE OF ENGINEERING, TIRUCHENGODE – 637 215
(Autonomous)

DATE: 17-09-2021

TIME: 03.00 p.m.

CIRCULAR

CLASSIFICATION	ROUTINE	IMMEDIATE
ORIGINATOR: PRINCIPAL		CIRCULATED TO: ECE, EEE, CSE and IT HoDs

Sub: Training Program for Third Year Students (2023 Batch) of ECE, EEE, CSE and IT - Reg.

Technical Training Program for ECE, EEE, CSE and IT Third Year (2023 Batch) has been organized from 20th September 2021 to 25th September 2021 (06 Days). The morning session will be conducted from 09.00 am to 12.30 pm, the afternoon session will be from 01.30 pm to 04.00 pm and assessment session will be conducted from 04.30 pm to 06.00pm. So, all the regular classes will be cancelled for the training program. Concerned HoDs are requested to instruct their students to be in physical mode (offline mode) and attend the whole training without fail.

Instructions to the Faculty through HoDs

ECE, EEE, CSE and IT Department T&P Co-ordinators are requested to monitor the attendance & discipline matters throughout the training program and update the HoDs concerned every day.

Instructions to the Students through Department T&P Co-ordinators & HoDs

1. Discipline
2. Punctuality
3. All students must wear mask and follow Standard Operating Procedure (SOP) to maintain Covid free campus. If any student not follows the above, he/she may not be allowed to proceed further in the process.

PRINCIPAL

Copy to:

1. ECE, EEE, CSE and IT HODS for favor of information and circulation among current Third year students and faculty members concerned.
2. All Training & Placement Coordinators.
3. Department Notice board.

EVIDENCE OF COMPLETION

Number of persons not received / seen: _____

Signature of Originator with date and time: _____

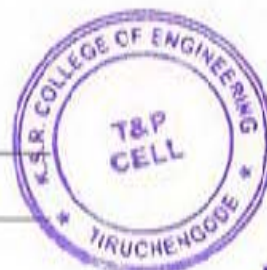

PRINCIPAL
K.S.R. COLLEGE OF ENGINEERING
K.S.R. KALVI NAGAR,
TIRUCHENGODE-637 215

KSR College of Engineering(Autonomous), Tiruchengode – 637 215
 Training and Placement Cell
 Training Schedule – 2023 Batch

Date	Content	Trainer	Batches
Day 1 <i>Monday</i> 20 th Sept, 2021	<ul style="list-style-type: none"> • Java – JDK, JVM, IDE's (Eclipse or NetBeans) • Awareness of Environmental path settings • General discussion about computer and Interpreter • Importance of Data types, Importance of Variable • Overview of Keywords • Information about Unicode – 8, 16, 32, 64 formats 	Mrs. P Vasuki	Batch 1
		Mrs. M K Nivodhini	Batch 2
		Mrs. S Suganya	Batch 3
		Mr. K Muthukumaran	Batch 4
Day 2 <i>Tuesday</i> 21 st Sept, 2021	<ul style="list-style-type: none"> • Operators – In-depth explanations along with real time programs (8 types of operators) • Expressions, Assignment, Arithmetic, Relational and Logical operators • Increment and Decrement operators • Operate – Assign operators, (+=, etc.) • The conditional operator, operator precedence, Implicit type conversions • Logical Building Practice 	Mrs. P Vasuki	Batch 1
		Mrs. M K Nivodhini	Batch 2
		Mrs. S Suganya	Batch 3
		Mr. K Muthukumaran	Batch 4
Day 3 <i>Wednesday</i> 22 nd Sept, 2021	<ul style="list-style-type: none"> • Importance of control statements, Conditional (if) statements • Data types and Variables 3 adding an else if • Conditional (Switch) statements • While and do – While loops, for loops • A for loop diagram enhanced for loop, the continue statements, the break statements • Logical Building Practice 	Mrs. P Vasuki	Batch 1
		Mrs. M K Nivodhini	Batch 2
		Mrs. S Suganya	Batch 3
		Mr. K Muthukumaran	Batch 4
	<ul style="list-style-type: none"> • Importance of methods – User defined and pre-defined 	Mrs. P Vasuki	Batch 1

Day 4 <i>Thursday</i> 23 rd Sept. 2021	<ul style="list-style-type: none"> • Calling methods, defining methods, Method parameter, Scope • So, why all the static? • Importance of Array • Importance of 1D, 2D and MultiD • For and Foreach – Variance on Array and Jagged Array • Logical Building Practice 	Mrs. M K Nivodhini	Batch 2
		Mrs. S Suganya	Batch 3
		Mr. K Muthukumaran	Batch 4
Day 5 <i>Friday</i> 24 th Sept, 2021	<ul style="list-style-type: none"> • Importance of strings • Usage of strings, Immutable String • String comparison – String concatenation • Substring methods of string class • StringBuffer class and StringBuilder class • String Vs StringBuffer Vs StringBuilder • Logical Building Practice 	Mrs. P Vasuki	Batch 1
		Mrs. M K Nivodhini	Batch 2
		Mrs. S Suganya	Batch 3
		Mr. K Muthukumaran	Batch 4
DAY 6 <i>Saturday</i> 25 th Sept, 2021	Assessment and Discussion		

FN Session
 (9.00 am to 12.30 pm)
AN Session
 (01.30 pm to 04.00 pm)
Assessment
 (04.30 pm to 06.00 pm)

*10.46 am – 11.00 am: Break

*12.30 pm – 01.30 pm Lunch Break

*02.46 pm – 03.00 pm: Break



PRINCIPAL
 K.S.R. COLLEGE OF ENGINEERING
 K.S.R. KALVI NAGAR,
 TIRUCHENGODE-637 215.

K.S.R. COLLEGE OF ENGINEERING (AUTONOMOUS), TIRUCHENGODE - 637 215

TRAINING AND PLACEMENT

TECHNICAL Training 2022 - 2023 Batch (20.09.2021 to 25.09.2021)

S.No	Reg No	Name	Branch	20.09.2021		21.09.2021		22.09.2021		23.09.2021		24.09.2021		25.09.2021	
				FN	AN	FN	AN	FN	AN	FN	AN	FN	AN	FN	AN
1	1913001	AATHMIGA M	CSE	P	P	P	P	P	P	P	P	P	P	P	P
2	1913002	ABISHEK	CSE	P	P	P	P	P	P	P	P	P	P	P	P
3	1913003	RADITYA	CSE	P	P	P	P	P	P	P	P	P	P	P	P
4	1913004	AJAIMARUDHU V	CSE	P	P	P	P	P	P	P	P	P	P	P	P
5	1913007	ARAVINTH. M	CSE	P	P	P	P	P	P	P	P	P	P	P	P
6	1913008	ARULMURUGAN S	CSE	P	P	P	P	P	P	P	P	P	P	P	P
7	1913009	ARUN. AP	CSE	P	P	P	P	P	P	P	P	P	P	P	P
8	1913010	ASIK.A	CSE	P	P	P	P	P	P	P	P	P	P	P	P
9	1913013	R. BHARATH KISHORE	CSE	P	P	P	P	P	P	P	P	P	P	P	P
10	1913014	CHANDRU KANNA R	CSE	P	P	P	P	P	P	P	P	P	P	P	P
11	1913015	DEEPASRI M	CSE	P	P	P	P	P	P	P	P	P	P	P	P
12	1913016	DEEPIKA.V	CSE	P	P	P	P	P	P	P	P	P	P	P	P
13	1913017	M DHARUN	CSE	P	P	P	P	P	P	P	P	P	P	P	P
14	1913018	DHINESH U	CSE	P	P	P	P	P	P	P	P	P	P	P	P
15	1913019	DHIVYA BHARATHI S	CSE	P	P	P	P	P	P	P	P	P	P	P	P
16	1913021	DINESH BABU SM	CSE	P	P	P	P	P	P	P	P	P	P	P	P
17	1913022	DINESH KUMAR M	CSE	P	P	P	P	P	P	P	P	P	P	P	P
18	1913024	DIVYADHARSHINI T	CSE	P	P	P	P	P	P	P	P	P	P	P	P
19	1913025	GANESAN K	CSE	P	P	P	P	P	P	P	P	P	F	P	P
20	1913028	GOKULFAJA LP	CSE	P	P	P	P	P	P	P	P	P	F	P	P
21	1913029	M. HARIHARAN	CSE	P	P	P	P	P	P	P	P	P	F	P	P
22	1913030	M.HARIOMPFKAAS	CSE	P	P	P	P	P	P	P	P	P	P	P	P
23	1913031	HARISH KUMAR M	CSE	P	P	P	P	P	F	P	P	P	P	P	P
24	1913032	JAGADEESHWARAM M	CSE	P	P	P	P	P	F	P	P	P	P	P	P
25	1913033	JAYASURIYA G	CSE	P	P	P	F	P	F	P	P	P	P	P	P
26	1913034	JAYAVELU S	CSE	P	P	P	F	P	F	P	F	P	P	P	P
27	1913035	JOVITHA D	CSE	P	P	P	F	P	F	P	F	P	P	P	P
28	1913036	P.KALAYARASAN	CSE	P	P	P	F	P	P	P	F	P	P	P	P
29	1913037	KAMALI K	CSE	P	P	P	F	P	P	P	F	P	P	P	P
30	1913038	KANISHKAR R	CSE	P	P	P	F	P	P	P	F	P	P	P	P
31	1913039	KANISHKA.S	CSE	P	P	P	P	P	P	P	P	P	P	P	P
32	1913040	KARTHI G	CSE	P	P	P	P	P	P	P	P	P	P	P	P
33	1913041	KARTHIKRAJ	CSE	P	P	P	P	P	P	P	P	P	P	P	P
34	1913043	KAVIN M	CSE	P	P	P	P	P	P	P	P	P	P	P	P



PRINCIPAL
K.S.R. COLLEGE OF ENGINEERING
K.S.R. KALVI NAGAR,
TIRUCHENGODE-637 215

35	1913044	KAVIN R	CSE	P	P	P	P	P	P	P	P	P	P	P	P	P
36	1913045	KEERTHANA S	CSE	P	P	P	P	P	P	P	P	P	P	P	P	P
37	1913046	KIRAN N	CSE	P	P	P	P	P	P	P	P	P	P	P	P	P
38	1913047	KOMALA M	CSE	P	P	P	P	P	P	P	P	P	P	P	P	P
39	1913052	K.MANOJ	CSE	P	P	P	P	P	P	P	P	P	P	P	P	P
40	1913053	MANYADHARSHINI S	CSE	P	P	P	P	P	P	P	P	P	P	P	P	P
41	1913054	MEIYARASAN P	CSE	P	P	P	P	P	P	P	P	P	P	P	P	P
42	1913001	DHANA DARSHINI.P	CSE	P	P	P	P	P	P	P	P	P	P	P	P	P
43	1913003	JODHIKA. S	CSE	P	P	P	P	P	P	P	P	P	P	P	P	P
44	1913701	SHEEBA R	CSE	A	A	A	P	P	P	P	P	P	P	P	P	P
45	1913055	MOHAMED ISMAIL SHEREEF N	CSE	P	P	P	P	P	P	P	P	P	P	P	P	P
46	1913056	MUGESH G	CSE	P	P	P	P	P	P	P	P	P	P	P	P	P
47	1913057	MYTHILI T	CSE	P	P	P	P	P	P	P	P	P	P	P	P	P
48	1913059	NAVEEN KJMAR M	CSE	P	P	P	P	P	P	P	P	P	P	P	P	P
49	1913061	NIRMALA C	CSE	P	P	P	P	P	P	A	A	A	A	A	A	A
50	1913062	NITHEESH KUMAR C	CSE	P	P	P	P	P	P	P	P	P	P	P	P	P
51	1913063	NIVETHA M	CSE	P	P	P	P	P	P	P	P	P	P	P	P	P
52	1913064	PAVITHRAM	CSE	A	A	A	P	P	P	P	P	P	P	P	P	P
53	1913065	PAVITHRA V	CSE	P	P	P	P	P	P	P	P	P	P	P	P	P
54	1913066	PRADEEP S	CSE	P	P	P	P	P	P	P	P	P	P	P	P	P
55	1913068	PRATHAP S	CSE	P	P	P	A	A	A	P	P	P	P	P	P	P
56	1913059	PRAVEENTH R	CSE	P	P	P	P	P	P	P	P	P	P	P	P	P
57	1913070	PREMALA J	CSE	P	P	P	P	P	P	P	P	P	P	P	P	P
58	1913071	RAAGHAVI V	CSE	P	P	P	P	P	P	P	P	P	P	P	P	P
59	1913072	RAGUBALAN R	CSE	P	P	P	P	P	P	P	P	P	P	P	P	P
60	1913074	RANIETH ASWIN R	CSE	P	P	P	P	P	P	P	P	P	P	P	P	P
61	1913075	RESHMA V	CSE	P	P	P	OD	OD	OD	OD	OD	OD	OD	OD	OD	OD
62	1913076	RITHIKA K	CSE	P	P	P	P	P	P	P	P	P	P	P	P	P
63	1913077	SABARINA S	CSE	P	P	P	P	P	P	P	P	P	P	P	P	P
64	1913078	SAKTHIVEL S	CSE	P	P	P	P	P	P	P	P	P	P	P	P	P
65	1913079	SAMUVEL I	CSE	P	P	P	P	P	P	P	P	P	P	P	P	P
66	1913080	SANJAY T	CSE	P	P	P	P	P	P	P	P	P	P	P	P	P
67	1913081	SANJAY K	CSE	P	P	P	P	P	P	P	P	P	P	P	P	P
68	1913083	SANJEVI M A	CSE	P	P	P	P	P	P	P	P	P	P	P	P	P
69	1913084	SARAN S B	CSE	P	P	P	P	P	P	P	P	P	P	P	P	P
70	1913085	SEENIVASAN P	CSE	P	P	P	P	P	P	P	P	P	P	P	P	P
71	1913087	SHEKAR R D	CSE	P	P	P	P	P	P	P	P	P	P	P	P	P
72	1913088	SIRAGIRIVELAN N	CSE	P	P	P	P	P	P	P	P	P	P	P	P	P
73	1913089	SRIHARI V	CSE	P	P	P	P	P	P	P	P	P	P	P	P	P



PRINCIPAL
K.S.R. COLLEGE OF ENGINEERING
K.S.R. KALVI NAGAR,
TIRUCHENGODE-637 215

74	1913090	SRINATH T	CSE	P	P	P	P	P	P	P	P	P	P	P	P	P
75	1913091	SRI S-IANGAR M	CSE	P	P	P	P	P	P	P	P	P	P	P	P	P
76	1913092	SUBRAMANI P	CSE	P	P	P	P	P	P	P	P	P	P	P	P	P
77	1913093	SURUTHI M	CSE	A	A	A	A	A	A	A	A	A	A	A	A	A
78	1913094	SURYA M	CSE	P	P	P	P	P	P	P	P	P	P	P	P	P
79	1913095	SURYA S	CSE	P	P	P	P	P	P	P	P	P	P	P	P	P
80	1913097	SWETHA G A	CSE	P	P	P	P	P	P	P	P	P	P	P	P	P
81	1913098	THARAGA PRASATH J	CSE	P	P	P	P	P	P	P	P	P	P	P	P	P
82	1913099	UDHAYA FRAKASH S	CSE	P	P	P	P	P	P	P	P	P	P	P	P	P
83	1913100	VANAJA R	CSE	P	P	P	P	P	P	P	P	P	P	P	P	P
84	1913101	VIBISH S B	CSE	P	P	P	P	P	P	P	P	P	P	P	P	P
85	1913103	VIJAY M	CSE	P	P	P	P	P	P	P	P	P	P	P	P	P
86	1913104	VIJAY P	CSE	P	P	P	P	P	P	P	P	P	P	P	P	P
87	1913105	VISHNU K	CSE	P	P	P	P	P	P	P	P	P	P	P	P	P
88	1913106	YAAZHINI P	CSE	P	P	P	P	P	P	P	P	P	P	P	P	P
89	1913107	YAVANIKA V	CSE	P	P	P	P	P	P	P	P	P	P	P	P	P
90	1913505	SATHISH F	CSE	P	P	P	P	P	P	P	P	P	P	P	P	P
91	1913506	SHIVARAJA M	CSE	P	P	P	P	P	P	P	P	P	P	P	P	P
92	1913508	SURYA KUMAR A	CSE	A	A	A	A	A	A	A	A	A	A	A	A	A
93	1913510	VIGNESH U	CSE	P	P	P	P	P	P	P	P	P	P	P	P	P
94	1921001	S.M.ABIRAMI	IT	P	P	P	P	P	P	P	P	P	P	P	P	P
95	1921003	A.ANILA	IT	P	P	P	P	P	P	P	P	P	P	P	P	P
96	1921004	AKSHAYAA RAJIA SHRI I.T	IT	P	P	P	P	P	P	P	P	P	P	P	P	P
97	1921005	ANNA LAKSHMI S	IT	P	P	P	P	P	P	P	P	P	P	P	P	P
98	1921006	ARAVIND B	IT	P	P	P	P	P	P	P	P	P	P	P	P	P
99	1921007	R. BALAJI	IT	P	P	P	P	P	P	P	P	P	P	P	P	P
100	1921008	BHUPESH G	IT	P	P	P	P	P	P	P	P	P	P	P	P	P
101	1921009	G.S.BLESSING ANTONY	IT	P	P	P	P	P	P	P	P	P	P	P	P	P
102	1921010	CHITRA S	IT	P	P	P	P	P	P	P	P	P	P	P	P	P
103	1921011	DEEPAK KUMAR A	IT	P	P	P	P	P	P	P	P	P	P	P	P	P
104	1921012	DHARUN.B.R.	IT	P	P	P	P	P	P	P	P	P	P	P	P	P
105	1921015	DHURGADDEVI S	IT	P	P	P	P	P	P	P	P	P	P	P	P	P
106	1921016	DINESH R	IT	P	P	P	P	P	P	P	P	P	P	P	P	P
107	1921017	S.GCKUL RAJA	IT	P	P	P	P	P	P	P	P	P	P	P	P	P
108	1921018	GOPALAKRISHNAN S	IT	P	P	P	P	P	P	P	P	P	P	P	P	P
109	1921019	GOWTHAM. D	IT	P	P	P	P	P	P	P	P	P	P	P	P	P
110	1921020	GUNALAN N	IT	P	P	P	P	P	P	P	P	P	P	P	P	P
111	1921021	HARIKRISHNAN S	IT	P	P	P	P	P	P	P	P	P	P	P	P	P
112	1921024	S.KAMALEE	IT	P	P	P	P	P	P	P	P	P	P	P	P	P



PRINCIPAL
K.S.R. COLLEGE OF ENGINEERING
K.S.R. KALVI NAGAR,
TIRUCHENGODE-617 215

113	1921025	P.BKAMALESREE	IT	P	P	P	P	P	P	P	P	P	P	P	P	P
114	1921026	R.KAVIN KUMAR	IT	P	P	P	P	P	P	P	P	P	P	P	P	P
115	1921027	LOGESH.V	IT	P	P	P	P	P	P	P	P	P	P	P	P	P
116	1921028	MYLRAJR	IT	P	P	P	P	P	P	P	P	P	P	P	P	P
117	1921030	NANDHIMI.S	IT	P	P	P	P	P	P	P	P	P	P	P	P	P
118	1921031	NANDHIMI S	IT	P	P	P	P	P	P	P	P	P	P	P	P	P
119	1921032	NATHEEM.J	IT	P	P	P	P	P	P	P	P	P	P	P	P	P
120	1921033	NISHANTH.R	IT	P	P	P	P	P	P	P	P	P	P	P	P	P
121	1921034	PAVITHRA M	IT	P	P	P	P	P	P	P	P	P	P	P	P	P
122	1921035	PRABHU.G	IT	P	P	P	P	P	P	P	P	P	P	P	P	P
123	1921036	PRASANTH R	IT	P	P	P	P	P	P	P	P	P	P	P	P	P
124	1921037	PRMOTH MAHAJAN	IT	P	P	P	P	P	P	P	P	P	P	P	P	P
125	1921038	PUSHPARAJ D	IT	P	P	P	P	P	P	P	P	P	P	P	P	P
126	1921039	RAGUL G	IT	P	P	P	P	P	P	P	P	P	P	P	P	P
127	1921040	B RAHUL	IT	A	A	A	A	A	A	A	A	A	A	A	A	A
128	1921041	S.RAJKUMAR	IT	P	P	P	P	P	P	P	P	P	P	P	P	P
129	1921042	RAMESHKRISHNAN M	IT	P	P	P	P	P	P	P	P	P	P	P	P	P
130	1921043	RANIITH KUMAR T	IT	P	P	P	P	P	P	P	P	P	P	P	P	P
131	1921045	SARAVANAN B	IT	P	P	P	P	P	P	P	P	P	P	P	P	P
132	1921046	SASIDHARAN.S	IT	P	P	P	P	P	P	P	P	P	P	P	P	P
133	1921047	B.SNEKA	IT	P	P	P	P	P	P	P	P	P	P	P	P	P
134	1921048	SOHAIL AHMED M	IT	P	P	P	P	P	P	P	P	P	P	P	P	P
135	1921049	SOUNDAR M	IT	P	P	P	P	P	P	P	P	P	P	P	P	P
136	1921051	N SCWMIYA	IT	P	P	P	P	P	P	P	P	P	P	P	P	P
137	1921052	STEFFI GFAF.R	IT	P	P	P	P	P	P	P	P	P	P	P	P	P
138	1921055	SURYA	IT	P	P	P	P	P	P	P	P	P	P	P	P	P
139	1921056	P.THANIYEAL	IT	P	P	P	P	P	P	P	P	P	P	P	P	P
140	1921057	P.S.THAVANISH	IT	P	P	P	P	P	P	P	P	P	P	P	P	P
141	1921058	THINAKARAN P	IT	P	P	P	P	P	P	P	P	P	P	P	P	P
142	1921060	B.VISHNU	IT	A	A	A	A	A	A	A	A	A	A	A	A	A
143	1921050	B.SCWMIYA	IT	P	P	P	P	P	P	P	P	P	P	P	P	P
144	1921044	G.SANTHOSH	IT	P	P	P	P	P	P	P	P	P	P	P	P	P
145	1921054	J.SUREENDHAR	IT	P	P	P	P	P	P	P	P	P	P	P	P	P
146	1921059	J E VIJAY	IT	P	P	P	P	P	P	P	P	P	P	P	P	P
147	1915004	ASHOKKLMAF K	ECE	P	P	P	P	P	P	P	P	P	P	P	P	P
148	1915006	DINESH S	ECE	P	P	P	P	P	P	P	P	P	P	P	P	P
149	1915007	DINESHKUMAR T	ECE	P	P	P	P	P	P	P	P	P	P	P	P	P
150	1915008	DIWAHAR S J	ECE	P	P	P	P	P	P	P	P	P	P	P	P	P
151	1915010	GOWTHAM R	ECE	P	P	P	P	P	P	P	P	P	P	P	P	P



PRINCIPAL
K.S.R. COLLEGE OF ENGINEERING
K.S.R. KALVI NAGAR
TIRUCHENGODE-637 215

152	1915011	ILAVARASAN K	ECE	P	P	P	P	P	P	P	P	P	P	P	P	P
153	1915013	JAGADEEP S	ECE	P	P	P	P	P	P	P	P	P	P	P	P	P
154	1915015	JAYAPRAKASH. M	ECE	P	P	P	P	P	P	P	P	P	P	P	P	P
155	1915017	KALIDAS M	ECE	A	A	A	A	A	A	A	A	A	A	A	A	A
156	1915018	KAMARAJ	ECE	P	P	P	P	A	A	A	A	A	P	P	P	P
157	1915019	KARTHIKA DEVI. K	ECE	P	P	P	P	P	P	P	P	P	P	P	P	P
158	1915020	KAVIN M	ECE	P	P	P	P	P	P	P	P	P	P	P	P	P
159	1915021	KAVNESH K	ECE	P	P	P	P	P	P	P	P	P	P	P	P	P
160	1915022	KAVINMUTHU S	ECE	P	P	P	P	P	P	P	P	P	P	P	P	P
161	1915024	KIRANRAJ T	ECE	P	P	P	P	P	P	P	P	P	F	P	P	P
162	1915026	KUMAR.S	ECE	P	P	P	P	P	P	P	P	P	F	P	P	P
163	1915027	LINGESH S	ECE	P	P	P	P	P	P	P	P	P	F	P	P	P
164	1915028	LOGESH S D	ECE	P	P	P	P	P	P	P	P	P	F	P	P	P
165	1915029	LOKENDRAN.S	ECE	P	P	P	P	P	P	P	P	P	F	P	P	P
166	1915032	MANOJ T	ECE	P	P	P	P	P	P	P	P	P	F	P	P	P
167	1915040	PRABAKARAN R	ECE	P	P	P	P	P	P	P	P	P	F	P	P	P
168	1915041	PRADEEPA S	ECE	P	P	P	P	P	P	P	P	P	F	P	P	P
169	1915043	PRITHIVRAJ T	ECE	P	P	P	P	P	P	P	P	P	F	P	P	P
170	1915045	RAGULT	ECE	P	P	P	P	P	P	P	P	P	F	P	P	P
171	1915050	SANJAY R	ECE	P	P	P	P	P	P	P	P	P	F	P	P	P
172	1915053	SETHU B	ECE	P	P	P	P	P	P	P	P	P	F	P	P	P
173	1915063	SUKUMAR V	ECE	P	P	P	P	P	P	P	P	P	F	P	P	P
174	1915064	SUSHMAS	ECE	P	P	P	P	P	P	P	P	P	F	P	P	P
175	1915066	TAMILARASU.M	ECE	P	P	A	A	A	A	A	A	A	A	A	A	A
176	1915068	THILAGAS	ECE	P	P	P	P	P	P	P	P	P	F	P	P	P
177	1915069	THILAKBALAJESM	ECE	P	P	P	P	P	P	P	P	P	F	P	P	P
178	1915070	THIRUMURUGAN V	ECE	P	P	P	P	P	P	P	P	P	F	P	P	P
179	1915071	VASANTH R	ECE	P	P	P	P	P	P	P	P	P	F	P	P	P
180	1915072	VIGNESHV	ECE	P	P	P	P	P	P	P	P	P	F	P	P	P
181	1915074	VINOTHINI G	ECE	P	P	P	P	P	P	P	P	P	F	P	P	P
182	1915502	SREE HARISH N	ECE	P	P	P	P	P	P	P	P	P	F	P	P	P
183	1915503	TAMILSHRI S	ECE	P	P	P	P	P	P	P	P	P	F	P	P	P
184	1915002	ARAVINTHAN T	ECE	P	P	P	P	P	P	P	P	P	F	P	P	P
185	1915009	GOWRIMANOHARI S	ECE	P	P	P	P	P	P	P	P	P	F	P	P	P
186	1915025	KIS-IORED	ECE	P	P	P	P	P	P	P	P	P	F	P	P	P
187	1915036	MCNISHA D	ECE	P	P	P	P	P	P	P	P	P	F	P	P	P
188	1915038	NAVEENA. M	ECE	P	P	P	P	P	P	P	P	P	F	P	P	P
189	1915055	SHARAN S	ECE	P	P	P	P	P	P	P	P	P	F	P	P	P
190	1915059	SREE GANESHM	ECE	P	P	P	P	P	P	P	P	P	F	P	P	P



PRINCIPAL
K.S.R. COLLEGE OF ENGINEERING
K.S.R. KALVI NAGAR,
TIRUCHENGODE-637 215

191	1915061	SUBASHINI E	ECE	P	P	P	P	P	P	P	P	P	P	P	P	P
192	1915075	YOGESH. R	ECE	P	P	P	P	P	P	F	P	P	P	P	P	F
193	1915003	ARUNKUMAR S	ECE	P	P	P	P	P	P	F	P	P	P	P	P	P
194	1915030	MAGIBALAN R	ECE	OD	OD	P	P	P	P	P	P	P	P	P	P	P
195	1915033	MOHAN S	ECE	P	P	P	P	P	P	P	P	P	P	P	P	P
196	1915034	MOHANASELVAN.D.V	ECE	P	P	P	P	P	P	F	P	P	P	P	P	P
197	1915035	MOHANPRASATH.A	ECE	P	P	P	P	P	P	P	P	P	P	P	P	P
198	1915039	PERUMAL R	ECE	P	P	P	P	P	P	P	P	P	P	P	P	P
199	1915052	SELVA PRAVEEN S	ECE	P	P	P	P	P	P	P	P	P	P	P	P	F
200	1914001	ABINAYA N	EEE	P	P	P	P	P	P	P	P	P	P	P	P	F
201	1914007	DINESHWARAN K	EEE	P	P	P	P	P	P	P	P	P	P	P	P	F
202	1914008	DIVAKAR V	EEE	P	P	P	P	P	P	P	P	P	P	P	P	F
203	1914011	HARI GOKUL S	EEE	P	P	P	P	P	P	P	P	P	P	P	P	F
204	1914017	KAARTHKEYAN S	EEE	P	P	P	P	P	P	P	P	P	P	P	P	F
205	1914013	KABEENA K J	EEE	P	P	P	P	P	P	P	P	P	P	P	P	F
206	1914021	KAVIN J R	EEE	P	P	P	P	P	P	P	P	P	P	P	P	F
207	1914025	KOWSIKPRABU R	EEE	P	P	P	P	P	P	P	P	P	P	P	P	F
208	1914026	MOHAMMED AL FAHAD	EEE	OD	OD	OD	CD	OC	OD	OD	OD	OD	OD	OD	OD	OD
209	1914028	MOHAN R	EEE	P	P	P	P	P	P	P	P	P	P	P	P	F
210	1914029	NALAN R	EEE	P	P	P	P	P	P	P	P	P	P	P	P	F
211	1914031	NAVEEN KUMAR P	EEE	P	P	P	P	P	P	P	P	P	P	P	P	F
212	1914036	RANJITHKUMAR R	EEE	P	P	P	P	P	P	P	P	P	P	P	P	P
213	1914039	SATHISHKUMAR A	EEE	P	P	P	A	P	P	P	P	P	P	F	P	P
214	1914041	SIVAKUMAR S	EEE	P	P	P	P	P	P	P	P	P	P	F	P	P
215	1914042	SOMESHKANNAN V	EEE	P	P	P	P	P	P	P	P	P	P	P	P	P
216	1914043	SRIDHARA	EEE	P	P	P	P	P	P	P	P	P	P	P	P	P
217	1914046	SURYAPRAKASH S	EEE	P	P	P	P	P	P	P	P	P	P	P	P	P
218	1914047	THANUJA G V	EEE	P	P	P	P	P	P	P	P	P	P	P	P	P
219	1914049	VIGNESHE	EEE	P	P	P	P	P	P	P	P	P	P	P	P	P
220	1914051	YOGESHRAJ P	EEE	P	P	P	F	P	P	P	P	P	P	P	P	P
221	1914508	NAVANEETHAKRISHNAN	EEE	P	P	P	F	P	P	P	P	P	P	P	P	P



Signature
 PRINCIPAL
 K.S.R. COLLEGE OF ENGINEERING
 K.S.R. KALVI NAGAR,
 TIRUCHENGODE-637 215





K.S.R. COLLEGE OF ENGINEERING

KSRCE/QM/8.6/22/PDC

(Autonomous)

TIRUCHENGODE - 637 215. TAMILNADU, INDIA.

Approved by AICTE, New Delhi, Anna University, Chennai & Accredited by NBA and NAAC with 'A' Grade

Professionals Development Cell

Certificate of Participation

This is to certify that Mr./Ms. ABISHEK.....
 of COMPUTER SCIENCE AND ENGINEERING..... department has participated in the
TECHNICAL TRAINING PROGRAMME - JAYA.....
 programme held at TRAINING AND PLACEMENT CELL - KSRCE.....
 on 20/9/21 to 25/9/21. We wish the student all success.

Date: 25/09/2021

[Signature]
 Organizer

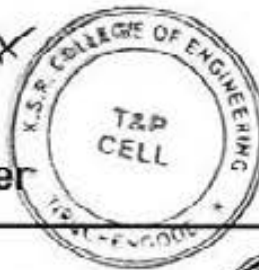

[Signature]
 Co-ordinator



[Signature]
 Principal

[Signature]
 PRINCIPAL
 K.S.R. COLLEGE OF ENGINEERING
 K.S.R. KALVI NA
 TIRUCHENGODE-637 215



HIGHER EDUCATIONAL CELL





K.S.R. COLLEGE OF ENGINEERING

(Autonomous)

TIRUCHENGODE - 637 215. TAMILNADU, INDIA.

Approved by AICTE, New Delhi, Anna University, Chennai & Accredited by NBA and NAAC with 'A' Grade

Professionals Development Cell

Certificate of Participation

This is to certify that Mr./Ms. S. KAMALEE
 of INFORMATION TECHNOLOGY department has participated in the
TECHNICAL TRAINING PROGRAMME - JAVA
 programme held at TRAINING AND PLACEMENT CELL - KSRCE
 on 20/09/21 to 25/09/21. We wish the student all success.

Date: 25/09/2021

[Signature]
 Organizer

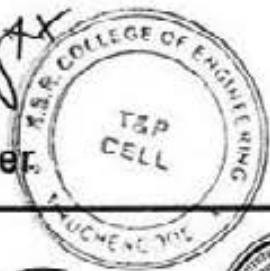

[Signature]
 Co-ordinator



[Signature]
 Principal
 K.S.R. COLLEGE OF ENGINEERING
 K.S.R. KALVI NAGAR,
 TIRUCHENGODE-637 215



HIGHER EDUCATIONAL CELL





KSRCE/QM/8.6/22/PDC

K.S.R. COLLEGE OF ENGINEERING

(Autonomous)

TIRUCHENGODE - 637 215. TAMILNADU, INDIA.

Approved by AICTE, New Delhi, Anna University, Chennai & Accredited by NBA and NAAC with 'A' Grade

Professionals Development Cell

Certificate of Participation

This is to certify that Mr./Ms. CHITRA S.....
 of INFORMATION TECHNOLOGY..... department has participated in the
TECHNICAL TRAINING PROGRAMME - JAVA.....
 programme held at TRAINING AND PLACEMENT CELL - KSRCE.....
 on 20/9/21 to 25/09/21.. We wish the student all success.

Date: 25/09/2021

[Signature]
 Organizer



[Signature]
 Co-ordinator



[Signature]
 Principal

PRINCIPAL
 K.S.R. COLLEGE OF ENGINEERING
 K.S.R. KALVI NAGAR,
 TIRUCHENGODE - 637 215



HIGHER EDUCATIONAL CELL





K.S.R. COLLEGE OF ENGINEERING

KSRCE/QM/8.6/22/PDC

(Autonomous)

TIRUCHENGODE - 637 215. TAMILNADU, INDIA.

Approved by AICTE, New Delhi, Anna University, Chennai & Accredited by NBA and NAAC with 'A' Grade

Professionals Development Cell

Certificate of Participation

This is to certify that Mr./Ms. V. JAY. M.
 of COMPUTER SCIENCE AND ENGINEERING department has participated in the
TECHNICAL TRAINING PROGRAMME - JAVA
 programme held at TRAINING AND PLACEMENT CELL - KSRCE
 on 20/9/21 to 25/9/21. We wish the student all success.

Date: 25/09/2021

 Organizer



 Co-ordinator



 Principal

 PRINCIPAL
 K.S.R. COLLEGE OF ENGINEERING
 K.S.R. KALVI NAGAR
 TIRUCHENGODE-637 215.



HIGHER EDUCATIONAL CELL



2021-2022 16

KSRCE/QM/5.5.3/01/2020-21/TP215

K.S.R. COLLEGE OF ENGINEERING, TIRUCHENGODE – 637 215
(Autonomous)

DATE: 20-09-2021

TIME: 04.00 p.m.

CIRCULAR

CLASSIFICATION	ROUTINE	IMMEDIATE
ORIGINATOR: PRINCIPAL		CIRCULATED TO: Auto, Civil and Meech HoDs

Sub.: Training Program Phase – II for Third Year Core Branch Students (2023 Batch) - Reg.

Technical, Soft Skill & Aptitude Training Program Phase – II for all Third Year Core Branch Students (2023 Batch) has been organized **from 21st September 2021 to 25th September 2021 (05 Days)**. The morning session will be conducted **from 09.00 am to 12.30 pm**, the afternoon session will be from **01.30 pm to 04.00 pm**. So, all the regular classes will be canceled for the training program. Concerned HoDs and Department Placement coordinators are requested to instruct their students to be in physical mode to them on time and attend the whole training without fail.

Instructions to the Faculty through HoDs

1. All the Department T&P Co-ordinators are requested to monitor the attendance & discipline matters throughout the training program and update the HoDs concerned every day.

Instructions to the Students through Department T&P Co-ordinators & HoDs

1. Discipline
 2. Punctuality
 3. All Students must wear mask and follow Standard Operating System (SOP) to maintain Covid free Campus.
- If any student not follows the above he/she may not be allowed to proceed further in the process.

G. S. [Signature]
20/9/21
T & P Head

[Signature]
PRINCIPAL

Copy to:

1. Auto, Civil and Meech HoDs for favor of information and circulation among current Third year students and faculty members concerned.
2. All Training & Placement Coordinators.
3. Department Notice board.



EVIDENCE OF COMPLETION

Number of persons not received / seen: - _____

Signature of Originator with date and time: _____

[Signature]
PRINCIPAL
K.S.R. COLLEGE OF ENGINEERING
K.S.R. KALVI NAGAR,
TIRUCHENGODE-637 215

KSR College of Engineering(Autonomous), Tiruchengode – 637 215

Training and Placement Cell

Training Schedule – Campus Drive 2023 Batch

Phase II – 21st Sep, 2021 - 25th Sep, 2021

Automobile, Civil and Mechanical

Soft Skills				
Dates	Timing	Content	Trainer	Batch
Day 1 Tuesday 21 st Sep , 2021	9.00 am - 10.45 am	<ul style="list-style-type: none"> • Career Planning & Campus Opportunities • Resume Building & Presentation • SWOT Analysis & Self Introduction • Essay Writing, Group Discussion & Writing Effective Emails 	Dr.Gowrisankar/ENG	Batch I
	11.00 am – 12.30 pm			
	01.30 pm – 04.00 pm		Mr.Sunej/ENG	Batch II
Technical Training – C				
Date	Time	Content	Trainer	Batches
Day 2 Wednesday 22 nd Sep, 2021	9.00 am - 10.45 am	<ul style="list-style-type: none"> • Basics, Variable Declarations, Definition and Scope, Data Types • Operators, Storage Classes & I/O • Pre-processor and Control Statements 	Mr.Gowtham	Batch I
	11.00 am – 12.30 pm			
	01.30 pm – 02.30 pm		Miss.Sabana Yasmin	Batch II
Day 3 Thursday 23 rd Sep , 2021	9.00 am - 10.45 am	<ul style="list-style-type: none"> • Array and Strings • Functions • Pointers 	Mr.Gowtham	Batch I
	11.00 am – 12.30 pm			
	01.30 pm – 02.30 pm		Miss.Sabana Yasmin	Batch II
Quantitative Aptitude				
Day 4 Friday 24 th Sep , 2021	9.00 am - 10.45 am	Quantitative Aptitude	Mr.Giridharan	Batch I & II
	11.00 am – 12.30 pm			
	01.30 pm – 02.30 pm			
Day 5 Saturday 25 th Sep , 2021	9.00 am - 10.45 am	Quantitative Aptitude	Mr.Giridharan	Batch I & II
	11.00 am – 12.30 pm			
	01.30 pm – 02.30 pm			

*10.45 am – 11.00am: Break

*12.30 Noon – 1.30 pm Lunch Break

G. S. S.
20/9/21
T & P Head



Signature

K.S.R. COLLEGE OF ENGINEERING(Autonomous), TIRUCHENGODE - 637 215
TRAINING & PLACEMENT CELL
CIRCUIT BRABCH THIRD YEAR STUDENTS 2023 BATCH
Technical (INTERNAL) TRAINING DAILY ATTENDANCE SHEET
20-09-2021 - Attendance

S. NO	BRANCH	TOTAL STUDENT	FN		AN	
			PRESENT	ABSENT	PRESENT	ABSENT
3	CSE	103	93	10	93	10
4	ECE	70	60	10	60	10
5	EEE	64	49	15	49	15
6	IT	60	52	8	52	8
TOTAL		297	254	43	254	43

TRAINING OFFICER
Dr. Anguraj S

G. S. ¹/_{21/9/21}
TRAINING AND PLACEMENT
(Dr. G. Singaravel)

PRINCIPAL



PRINCIPAL,
K.S.R. COLLEGE OF ENGINEERING
K.S.R. KALVI NAGAR,
TIRUCHENGODE-637 215.

K.S.R. COLLEGE OF ENGINEERING(Autonomous), TIRUCHENGODE - 637 215
 TRAINING & PLACEMENT CELL
 CIRCUIT BRANCH THIRD YEAR STUDENTS 2023 BATCH
 Technical (INTERNAL) TRAINING DAILY ATTENDANCE SHEET
 21-09-2021 - Attendance

S. NO	BRANCH	TOTAL STUDENTS	FN		AN	
			PRESENT	ABSENT	PRESENT	ABSENT
3	CSE	103	97	6	97	6
4	ECE	70	62	8	62	8
5	EEE	64	54	10	54	10
6	IT	60	53	7	53	7
TOTAL		297	266	31	266	31

S. Anuraj
 TRAINING OFFICER,
 Dr. Anuraj S

G. S. S
 21/9/21
 TRAINING AND PLACEMENT
 (Dr. G. Singaravel)

PN
 PRINCIPAL



K.S.R. COLLEGE OF ENGINEERING(Autonomous), TIRUCHENGODE - 637 215
 TRAINING & PLACEMENT CELL
 CORE BRANCH THIRD YEAR STUDENTS 2023 BATCH
 SOFTSKILLS (INTERNAL) TRAINING DAILY ATTENDANCE SHEET
 21-09-2021 - Attendance

S. NO	BRANCH	TOTAL STUDENTS	FN		AN	
			PRESENT	ABSENT	PRESENT	ABSENT
3	AUTO	40	29	11	40	29
4	CIVIL	22	16	6	22	16
5	MECH	71	58	13	71	58
TOTAL		133	103	30	133	103

S. Anuraj
 TRAINING OFFICER,
 Dr. Anuraj S

G. S. S
 21/9/21
 TRAINING AND PLACEMENT
 (Dr. G. Singaravel)

PN
 PRINCIPAL

PRINCIPAL
 K.S.R. COLLEGE OF ENGINEERING
 K.S.R. KALVI NAGAR,
 TIRUCHENGODE-637 215

K.S.R. COLLEGE OF ENGINEERING (AUTONOMOUS), TIRUCHENGODE - 637 215

TRAINING AND PLACEMENT

Soft Skills Training 2022 for 2023 Batch (21.09.2021 To 25.09.2021)

S.No	Reg No	Name	Branch
1	1911001	Balachandar. A	AUTO
2	1911003	Deepaprasanth. M	AUTO
3	1911004	Dharani.M	AUTO
4	1911005	Dharunraj.P	AUTO
5	1911006	Gokul Pranesh.C	AUTO
6	1911007	Hari prasath.J	AUTO
7	1911008	Hari Ganesh.H	AUTO
8	1911011	Kaviprasanth.P	AUTO
9	1911012	Naveen kumar R D	AUTO
10	1911013	Nitheesh.B	AUTO
11	1911015	Nithyashree R	AUTO
12	1911016	Praveen .M	AUTO
13	1911017	Ragul .S	AUTO
14	1911019	Sathish.S	AUTO
15	1911020	Sridhar.V.R	AUTO
16	1911021	Subasakthivel M	AUTO
17	1911023	Sugumar D	AUTO
18	1911024	Sujeeth V	AUTO
19	1911025	Vasanthakumar K.S	AUTO
20	1911026	Vijay.P	AUTO
21	1911501	Arunkumaran.R	AUTO
22	1911502	Bharath P	AUTO
23	1911503	Dhanish.V	AUTO
24	1911505	Gowshik A	AUTO
25	1911507	Mohanraj B	AUTO
26	1911508	Mohanraj S	AUTO
27	1911509	Murali R	AUTO
28	1911510	Naveen M	AUTO
29	1911511	Prabhu. S	AUTO
30	1911512	Praveen M	AUTO
31	1911513	Raaj Kumar M	AUTO
32	1911514	Ragunath G	AUTO
33	1911515	Raja.V	AUTO
34	1911516	Santhoshkumar A	AUTO
35	1911517	Santhoshkumar K.M	AUTO
36	1911518	Sathiyananthan. KKK	AUTO
37	1916001	Aravinth karthi s	MECH
38	1916002	ARJUN AJAYAGOSH	MECH
39	1916003	ASTILE ROSHAN N	MECH
40	1916004	BARATH N S	MECH
41	1916005	CHANDRU.A	MECH
42	1916007	CHENNAKESAVAN V	MECH

PRINCIPAL
K.S.R. COLLEGE OF ENGINEERING
K.S.R. KALVI NAGAR,
TIRUCHENGODE-637 215.

43	1916008	DAYANAND G V	MECH
44	1916009	R Dhayanithi	MECH
45	1916010	DINESH P	MECH
46	1916011	DINESHKUMAR M	MECH
47	1916012	ELAVARASAN.A	MECH
48	1916013	GNANASELVARAJ P	MECH
49	1916014	GOKUL	MECH
50	1916016	Gopalakrishnan.T	MECH
51	1916018	GUHAN P	MECH
52	1916019	GURUNASAMY G	MECH
53	1916020	KAMESH.S	MECH
54	1916021	Kavi. M	MECH
55	1916025	B.KAVINRAJ	MECH
56	1916026	V KAVIYARASAN	MECH
57	1916027	KIRAN VARGHESE	MECH
58	1916028	KISHORE J	MECH
59	1916029	S. Kowshikan	MECH
60	1916031	MAHENDRA KUMAR R	MECH
61	1916032	MAHESHKUMAR M	MECH
62	1916033	MATHANKANNAN M	MECH
63	1916034	MATHESH M	MECH
64	1916036	E PRAHATHEESWAR	MECH
65	1916037	Praveen. R	MECH
66	1916038	Priyadharsan	MECH
67	1916039	PUVI ARASU S	MECH
68	1916040	S. RITHICK	MECH
69	1916041	V.K.SABARIKIRIRAJ	MECH
70	1916042	Santhosh Govindharaju	MECH
71	1916043	SATHISH C	MECH
72	1916044	Senthilvelan B	MECH
73	1916048	SRINIVASAN.R	MECH
74	1916049	Subash prabhu.M	MECH
75	1916050	SUDHARSAN C	MECH
76	1916051	SUNDARESAN S	MECH
77	1916052	S. Thinakaran	MECH
78	1916053	VELMURUGAN.A	MECH
79	1916501	AJAYPRASANTH M	MECH
80	1916502	M.Arunkumar	MECH
81	1916503	DEEPANKUMAR K	MECH
82	1916504	Dhanushraja T	MECH
83	1916505	DHARUNPRASATH.V	MECH
84	1916506	DHUVARAGA PRASATH.S	MECH
85	1916509	GOKUL.R	MECH
86	1916509	GOKUL.R	MECH
87	1916510	GOKULRAJ.A	MECH
88	1916511	JAGADESH. J	MECH
89	1916512	KALAIYARASAN T	MECH

90	1916513	Kishor G	MECH
91	1916514	LOGESHWARAN M	MECH
92	1916515	C.MAKESKUMAR	MECH
93	1916517	MOHANRAJA R	MECH
94	1916518	NANDHA KUMAR S	MECH
95	1916519	E.J.NANDHA KUMAR	MECH
96	1916520	Nandhakumar.S	MECH
97	1916521	NAVEENKUMAR P	MECH
98	1916523	B.RANJITH KUMAR	MECH
99	1916524	g.rohit	MECH
100	1916525	SAKTHIVEL.K	MECH
101	1916526	SAKTHIVELAN N	MECH
102	1916528	SANJAY V	MECH
103	1916529	M. SANTHOSH	MECH
104	1916531	SATHEESHKUMAR	MECH
105	1916532	R. TAMILINIYAN	MECH
106	1916533	K.Vasanthakumar	MECH
107	1916536	YOGESH AYANAR.S	MECH
108	1916013	GNANASELVARA/ P	MECH
109	1916014	GOKUL C	MECH
110	1916020	KAMESH S	MECH
111	1916021	KAVI M	MECH
112	1916053	VELMURUGAN.A	MECH
113	1916502	ARUNKUMAR M	MECH
114	1916505	DHARUNPRASATH.V	MECH
115	1916507	MOHAMED FAIZUL	MECH
116	1916513	KISHORE G	MECH
117	1916514	LOGESHWARAN M	MECH
118	1916515	MAKESKUMAR C	MECH
119	1916516	MANOJ G	MECH
120	1916517	MOHANRAJA R	MECH
121	1916520	NANDHAKUMAR S	MECH
122	1916521	NAVEENKUMAR P	MECH
123	1912001	ARULKUMARAN S	CIVIL
124	1912002	K.DHILEEPAN	CIVIL
125	1912003	Gowtham. M	CIVIL
126	1912004	Karunakaran	CIVIL
127	1912005	Kavinraj. T	CIVIL
128	1912006	Madhankumar. P	CIVIL
129	1912007	T.MANICKAVEL	CIVIL
130	1912008	K.MONISH	CIVIL
131	1912009	R.Nallenthiran	CIVIL
132	1912011	S.Prabhakaran	CIVIL
133	1912012	Sanjay Kumaran D	CIVIL

S. Gnanajayam
21 Sep 21



(Handwritten signature)

PRINCIPAL
K.S.R. COLLEGE OF ENGINEERING
K.S.R. KALVI NAGAR,
TIRUCHENGODE-637 215

KSR College of Engineering (Autonomous), Tiruchengode – 637 215

Training and Placement Cell

Phase – 1 Soft skill Training Schedule for 2023 Batch

FN	AN
Achievers Tech Talks	Interaction
Career Planning And Campus Opportunities	Orientation
SWOT Analysis & Self Introduction	Individual Activity
Resume Building & Presentation	Individual Activity
Essay writing	Practice
Group Discussion	Group Activity
Writing Effective Emails	Individual Activity

FN Session

9.30 am to 12.30 pm

AN Session

01.30 pm to 04.00 pm

Assessment

04.30 pm to 06.00 pm

*10.46 am – 11.00am - Break

*12.30 pm – 01.30 pm -Lunch Break

* 02.46 pm – 03.00 pm – Break

S. Gnanapriya
21 Sep 21



PRINCIPAL
K.S.R. COLLEGE OF ENGINEERING
K.S.R. KALVI NAGAR,
TIRUCHENGODE-637 215



KSRCE/QM/8.6/22/PDC

K.S.R. COLLEGE OF ENGINEERING

(Autonomous)

TIRUCHENGODE - 637 215. TAMILNADU, INDIA.

Approved by AICTE, New Delhi, Anna University, Chennai & Accredited by NBA and NAAC with 'A' Grade

Professionals Development Cell

Certificate of Participation

This is to certify that Mr./Ms. KAVI M of MECHANICAL ENGINEERING department has participated in the TECHNICAL, SOFTSKILL AND APTITUDE TRAINING PHASE - II programme held at TRAINING AND PLACEMENT CELL - KSRCE on 21.9.21 - 25.9.21. We wish the student all success.

Date: 25.09.2021

S. Srinivasan
Organizer



G. S. Srinivasan
Co-ordinator



[Signature]
Principal

[Signature]
Principal

K.S.R. COLLEGE OF ENGINEERING
K.S.R. KALVI NAGAR,
TIRUCHENGODE-637 215



HIGHER EDUCATIONAL CELL





K.S.R. COLLEGE OF ENGINEERING

(Autonomous)

TIRUCHENGODE - 637 215.TAMILNADU, INDIA.

Approved by AICTE, New Delhi, Anna University, Chennai & Accredited by NBA and NAAC with 'A' Grade

Professionals Development Cell

Certificate of Participation

This is to certify that Mr./Ms-.....MONISH K.....
of.....CIVIL ENGINEERING.....department has participated in the
.....TECHNICAL, SOFTSKILL AND APTITUDE TRAINING PHASE - II.....
programme held at.....TRAINING AND PLACEMENT CELL - KSRCE.....
on 21.09.21 - 25.9.21. We wish the student all success.

Date: 25.9.2021

S. Ananya
Organizer

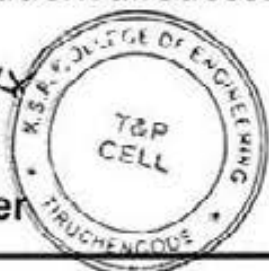

G. S. S.
Co-ordinator



[Signature]
Principal
K.S.R. COLLEGE OF ENGINEERING
K.S.R. KALVI NAGAR
TIRUCHENGODE-637 215



HIGHER EDUCATIONAL CELL





K.S.R. COLLEGE OF ENGINEERING

KSRCE/QM/8.6/22/PDC

(Autonomous)

TIRUCHENGODE - 637 215. TAMILNADU, INDIA.

Approved by AICTE, New Delhi, Anna University, Chennai & Accredited by NBA and NAAC with 'A' Grade

Professionals Development Cell

Certificate of Participation

This is to certify that Mr./Ms. DHIVESH P
of MECHANICAL ENGINEERING department has participated in the
TECHNICAL, SOFTSKILL AND APTITUDE TRAINING PHASE - II
programme held at TRAINING AND PLACEMENT CELL - KSRCE
on 21.9.21 - 25.9.21. We wish the student all success.

Date: 25.09.2021

S. Manjappa
Organizer

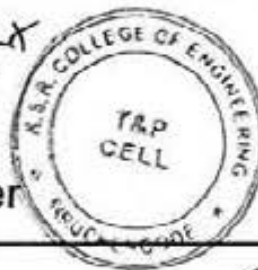

G. F. S.
Co-ordinator



K. S. R. Kalvi Nagesh
Principal
K.S.R. COLLEGE OF ENGINEERING
K.S.R. KALVI NAGESH
TIRUCHENGODE-637 215



HIGHER EDUCATIONAL CELL





K.S.R. COLLEGE OF ENGINEERING

(Autonomous)

TIRUCHENGODE - 637 215 TAMILNADU, INDIA

Approved by AICTE, New Delhi, Anna University, Chennai & Accredited by NBA and NAAC with 'A' Grade

Professionals Development Cell

Certificate of Participation

This is to certify that Mr./Ms. VIJAY P.
 of AUTOMOBILE ENGINEERING department has participated in the
TECHNICAL, SOFTSKILL AND APTITUDE TRAINING PHASE - II
 programme held at TRAINING AND PLACEMENT CELL - KSRCE
 on 21.9.21 - 25.9.21. We wish the student all success.

Date: 25.09.2021

 Organizer

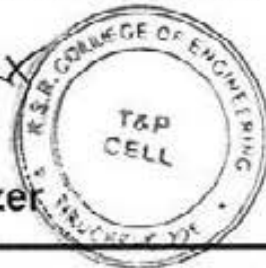

 Co-ordinator



 Principal

 PRINCIPAL
 K.S.R. COLLEGE OF ENGINEERING
 K.S.R. KALVI NAGAR,
 TIRUCHENGODE - 637 215



HIGHER EDUCATIONAL CELL



2021-2022
11

KSRCE/QM/5.5.3/01/2021-22/TP18

K.S.R. COLLEGE OF ENGINEERING, TIRUCHENGODE - 637 215
(Autonomous)

DATE: 13-10-2021

TIME: 01.00 p.m.

CIRCULAR

CLASSIFICATION	ROUTINE	IMMEDIATE
ORIGINATOR: PRINCIPAL		CIRCULATED TO: CSE HoD

Sub.: Training Program for Third Year Students (2023 Batch) of CSE (Batch 1) - Reg.

Aptitude Training Program for CSE (Batch 1) Third Year (2023 Batch) has been organized from 20th October 2021 to 26th October 2021 (06 Days). The morning session will be conducted from 09.30 am to 12.30 pm, the afternoon session will be from 01.30 pm to 04.00 pm and assessment will be conducted from 04.30 pm to 06.00 pm. So, all the regular classes will be cancelled for the training program. Concerned HoD is requested to instruct their students to be in physical mode (offline mode) and attend the whole training without fail.

Instructions to the Faculty through HoDs

CSE Department T&P Co-ordinator is requested to monitor the attendance & discipline matters throughout the training program and update the HoDs concerned every day.

Instructions to the Students through Department T&P Co-ordinators & HoD

1. Discipline
2. Punctuality
3. All students must wear mask and follow Standard Operating Procedure (SOP) to maintain Covid free campus. If any student not follows the above, he/she may not be allowed to proceed further in the process.

S. Srinivasan
13 Oct 21

[Signature]
PRINCIPAL

Copy to:

1. CSE HOD for favor of information and circulation among current Third year students and faculty members concerned.
2. All Training & Placement Coordinators.
3. Department Notice board.

EVIDENCE OF COMPLETION

Number of persons not received / seen: - _____

Signature of Originator with date and time: _____



[Signature]
PRINCIPAL
K.S.R. COLLEGE OF ENGINEERING
K.S.R. KALVI NAGAR,
TIRUCHENGODE-637 215

KSR College of Engineering (Autonomous), Tiruchengode – 637 215

Training and Placement Cell

Phase – 1 Aptitude Training Schedule for 2023 Batch

Date	FN		AN	
20.10.2021	Number System		Average	Assessment and Discussion
21.10.2021	Percentage		Profit and Loss	Assessment and Discussion
22.10.2021	Ratio Proportions		Problems on Ages	Assessment and Discussion
23.10.2021	Time Speed and Distance		Time and Work	Assessment and Discussion
25.10.2021	Permutation and Combination		Probability	Assessment and Discussion
26.10.2021	Blood Relation, Syllogism		Directions, Coding and Decoding	Assessment and Discussion

FN Session

9.30 am to 12.30 pm

AN Session

01.30 pm to 04.00 pm

Assessment

04.30 pm to 06.00 pm

*10.46 am – 11.00am - Break

*12.30 pm – 01.30 pm -Lunch Break

* 02.46 pm – 03.00 pm - Break

S. Arjunan
13 oct 21



PRINCIPAL
K.S.R. COLLEGE OF ENGINEERING
K.S.R. KALVI NAGAR,
TIRUCHENGODE-637 215

K.S.R. COLLEGE OF ENGINEERING (AUTONOMOUS), TIRUCHENGODE - 637 215

TRAINING AND PLACEMENT

Aptitude Training 2022 for 2023 Batch (20.10.2021 to 26.10.2021)

S.No	Reg No	Name	Branch
1	1913001	AATHMIGA M	CSE
2	1913002	ABISHEK	CSE
3	1913003	R.ADITYA	CSE
4	1913004	AJAIMARUDHU V	CSE
5	1913007	ARAVINTH. M	CSE
6	1913008	ARULMURUGAN S	CSE
7	1913009	ARUN. AP	CSE
8	1913010	ASIK.A	CSE
9	1913013	R. BHARATH KISHORE	CSE
10	1913014	CHANDRU KANNA R	CSE
11	1913015	DEEPASRI M	CSE
12	1913016	DEEPIKA.V	CSE
13	1913017	M.DHARUN	CSE
14	1913018	DHINESH U	CSE
15	1913019	DHIVYABHARATHI S	CSE
16	1913021	DINESH BABU SM	CSE
17	1913022	DINESH KUMAR M	CSE
18	1913024	DIVYADHARSHINI T	CSE
19	1913025	GANESAN K	CSE
20	1913028	GOKULRAJA L P	CSE
21	1913029	M. HARIHARAN	CSE
22	1913030	M.HARIOMPRAKAAS	CSE
23	1913031	HARISH KUMAR M	CSE
24	1913032	JAGADEESHWARAN M	CSE
25	1913033	JAYASURIYA G	CSE
26	1913034	JAYAVELU S	CSE
27	1913035	JOVITHA D	CSE
28	1913036	P. KALAIYARASAN	CSE
29	1913037	KAMALI.K	CSE
30	1913038	KANISHKAR R	CSE
31	1913039	KANISHKHA.S	CSE
32	1913040	KARTHI G	CSE
33	1913041	KARTHIKRAJ	CSE
34	1913043	KAVIN M	CSE
35	1913044	KAVIN.R	CSE
36	1913045	KEERTHANA S	CSE
37	1913046	KIRAN N	CSE
38	1913047	KOMALA M	CSE
39	1913052	K.MANOJ	CSE
40	1913053	MANYADHARSHINI S	CSE
41	1913054	MEIYARASAN P	CSE
42	1913501	DHANA DARSHINI.P	CSE

PRINCIPAL
K.S.R. COLLEGE OF ENGINEERING
K.S.R. KALVI NAGAR,
TIRUCHENGODE-637 215

43	1913503	JODHIKA. S	CSE
44	1913701	SHEEBA R	CSE
45	1913055	MOHAMED ISMAIL SHEREEF N	CSE
46	1913056	MUGESH G	CSE
47	1913057	MYTHILI T	CSE
48	1913059	NAVEEN KUMAR M	CSE
49	1913061	NIRMALA C	CSE

S. Srinivasan
20 Oct 21



PRINCIPAL
K.S.R. COLLEGE OF ENGINEERING
K.S.R. KALVI NAGAR,
TIRUCHENGODE-637 215

28	1913032	JAGADEESHWARAN M	CSE	BATCH 1	/	/	/	/	/	/	/	/	/	/	a	a
29	1913033	JAYASURIYA G	CSE	BATCH 1	/	/	/	/	/	/	/	/	/	/	/	/
30	1913034	JAYAVELU S	CSE	BATCH 1	/	/	/	/	/	/	/	/	a	a	/	/
31	1913035	JOVITHA D	CSE	BATCH 1	/	/	/	/	/	/	/	/	/	/	/	/
32	1913036	KALAIYARASAN P	CSE	BATCH 1	/	/	/	/	/	/	/	/	/	/	/	/
33	1913037	KAMALI.K	CSE	BATCH 1	/	/	/	/	/	a	/	/	/	/	/	/
34	1913038	KANISHKAR R	CSE	BATCH 1	/	/	/	/	/	/	/	/	/	/	/	/
35	1913039	KANISHKHA.S	CSE	BATCH 1	/	/	/	/	/	/	/	/	/	/	/	/
36	1913040	KARTHI G	CSE	BATCH 1	/	/	/	/	/	/	/	/	/	/	/	/
37	1913041	KARTHIKRAJ S	CSE	BATCH 1	/	/	a	a	a	a	/	/	/	/	/	/
38	1913043	Kavin M	CSE	BATCH 1	/	/	/	/	/	/	/	1*	/	/	/	/
39	1913044	KAVIN.R	CSE	BATCH 1	/	/	/	/	/	/	/	/	/	/	/	/
40	1913045	KEERTHANA S	CSE	BATCH 1	/	/	/	/	/	/	/	/	/	/	/	/
41	1913046	KIRAN N	CSE	BATCH 1	/	/	/	/	/	/	/	/	a	a	/	/
42	1913047	KOMALA.M	CSE	BATCH 1	/	/	/	/	/	a	/	/	/	/	/	/
43	1913048	KOWSIKAN B	CSE	BATCH 1	/	/	a	a	/	/	/	/	/	/	/	/
44	1913052	MANOJ.K	CSE	BATCH 1	/	/	/	/	/	/	/	/	/	/	/	/
45	1913053	MANYA DHARSHINI S	CSE	BATCH 1	/	/	/	/	/	/	/	/	/	/	/	/
46	1913054	MEIYARASAN P	CSE	BATCH 1	/	/	/	/	/	/	/	/	/	/	/	/
47	1913501	DHANA DARSHINI P	CSE	BATCH 1	/	/	/	/	/	/	aa	a	/	/	/	/
48	1913503	JODHIKA S	CSE	BATCH 1	/	/	/	/	/	/	aa	/	/	/	/	/
49	1913701	SHEEBA R	CSE	BATCH 1	/	/	/	/	/	/	/	/	/	/	/	/
TOTAL					49	49	49	49	49	49	49	49	49	49	49	49
PRESENT					46	45	44	43	46	44	45	44	44	44	44	44
ABSENT					03	04	05	06	03	05	04	05	05	05	05	
PLACEMENT CO ORDINATOR SIGN					slu	slu	slu	slu	slu	slu	slu	slu	slu	slu	slu	slu
HOD SIGN																
TRAINING OFFICER					S. Ganga	S. Ganga	S. Ganga	S. Ganga	S. Ganga	S. Ganga	S. Ganga	S. Ganga	S. Ganga	S. Ganga	S. Ganga	S. Ganga
PRINCIPAL																

PRINCIPAL
K.S.R. COLLEGE OF ENGINEERING
K.S.R. KALVI NAGAR,
TIRUCHENGODE-637 215

K.S.R. COLLEGE OF ENGINEERING (AUTONOMOUS), TIRUCHENGODE - 637215

TRAINING AND PLACEMENT CELL

STUDENT'S FEEDBACK FORM FOR TRAINING

Name of the Student: CSE - A (Ganesan) Reg. No.:

Date: 26/10/2021

Year/ Sem : II / 5th

Dept. : CSE

S. No.	Rate the Following	Trainer 1	Trainer 2	Trainer 3	Trainer 4	Trainer 5
	Trainer Name	<u>Giridharan</u>				
1	Content & Structure of the Training	<u>5</u>				
2	Clarity of Instructions	<u>5</u>				
3	Delivery of the Content	<u>5</u>				
4	Method of Delivery (Use of Aids)	<u>5</u>				
5	Handouts & Manuals	<u>5</u>				
6	Trainer's Communication	<u>5</u>				
7	Assistance from the Trainer	<u>5</u>				
8	"Hands on" Practice	<u>5</u>				
9	Attainment of Objective	<u>5</u>				
10	Time Management	<u>5</u>				
	Total	<u>50</u>				
How could this training be improved? (Quality/Quantity of the information presented, type of illustrations used).		-				
Mention the additional Training requirement if any.						

Rate the Trainers: Poor - 1, Fair - 2, Good - 3, Very Good - 4, Excellent - 5

Name of the Training Programme:

3rd Year Aptitude Training Programme
Phase - I

Name of the Training Agency:

Signature of the Student

Ganesan

PRINCIPAL
K.S.R. COLLEGE OF ENGINEERING
K.S.R. KALVI NAGAR,
TIRUCHENGODE-637 215



K.S.R. COLLEGE OF ENGINEERING (AUTONOMOUS), TIRUCHENGODE – 637215

TRAINING AND PLACEMENT CELL

STUDENT'S FEEDBACK FORM FOR TRAINING

Name of the Student: CSE - A (Javithan) Reg. No.:

Date: 26-10-21

Year/ Sem

: III / V

Dept. :

S. No.	Rate the Following	Trainer 1	Trainer 2	Trainer 3	Trainer 4	Trainer 5
	Trainer Name	Giridharan				
1	Content & Structure of the Training	4				✓
2	Clarity of Instructions	5				
3	Delivery of the Content	4				
4	Method of Delivery (Use of Aids)	4				
5	Handouts & Manuals	5				
6	Trainer's Communication	5				✓
7	Assistance from the Trainer	4				
8	"Hands on" Practice	5				✓
9	Attainment of Objective	4			✓	
10	Time Management	4			✓	
Total						
How could this training be improved? (Quality/Quantity of the information presented, type of illustrations used).		None				
Mention the additional Training requirement if any.						

Rate the Trainers: Poor – 1, Fair – 2, Good – 3, Very Good – 4, Excellent – 5

III - YEAR APTITUDE TRAINING
Name of the Training Programme: PHASE-I

Name of the Training Agency:

D. J. J.
Signature of the Student



PRINCIPAL
K.S.R. COLLEGE OF ENGINEERING
K.S.R. KALVI NAGAR,
TIRUCHENGODE-637 215

KSR College of Engineering (Autonomous), Tiruchengode – 637 215

Training and Placement Cell

Phase – 1 Aptitude Training Schedule for 2023 Batch

Date	FN	AN
20.10.2021	Number System	Average
21.10.2021	Percentage	Profit and Loss
22.10.2021	Ratio Proportions	Problems on Ages
23.10.2021	Time Speed and Distance	Time and Work
24.10.2021	Permutation and Combination	Probability
25.10.2021	Blood Relation	Directions
26.10.2021	Syllogism	Coding and Decoding

FN Session

9.30 am to 12.30 pm

AN Session

01.30 pm to 04.00 pm

Assessment

04.30 pm to 06.00 pm

*10.46 am – 11.00am - Break

*12.30 pm – 01.30 pm -Lunch Break

* 02.46 pm – 03.00 pm – Break

KSR College of Engineering (Autonomous), Tiruchengode – 637 215

Training and Placement Cell

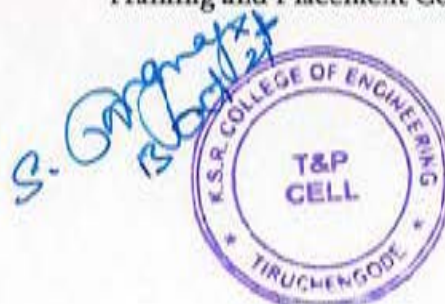

A handwritten signature in green ink is written over a rectangular purple stamp. The stamp contains the text 'PRINCIPAL' at the top, 'K.S.R. COLLEGE OF ENGINEERING' in the middle, and 'K.S.R. KALVI NAGAR, TIRUCHENGODE-637 215' at the bottom.



K.S.R. COLLEGE OF ENGINEERING

KSRCE/QM/8.6/22/PDC

(Autonomous)

TIRUCHENGODE - 637 215. TAMILNADU, INDIA.

Approved by AICTE, New Delhi, Anna University, Chennai & Accredited by NBA and NAAC with 'A' Grade

Professionals Development Cell

Certificate of Participation

This is to certify that Mr./Ms. MYTHILI T.
 of COMPUTER SCIENCE AND ENGINEERING department has participated in the
APTITUDE TRAINING PROGRAMME
 programme held at TRAINING AND PLACEMENT CELL - KSRCE
 on 20.10.21 - 26.10.21. We wish the student all success.

Date: 26.10.2021

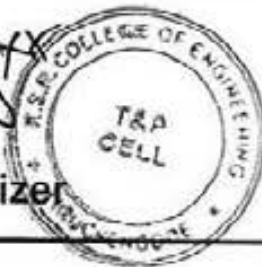
S. Srinivasan
 Organizer

G. Srinivasan
 Co-ordinator



[Signature]
 Principal
 K.S.R. COLLEGE OF ENGINEERING
 K.S.R. KALVI NAGAR
 TIRUCHENGODE-637 215



HIGHER EDUCATIONAL CELL





K.S.R. COLLEGE OF ENGINEERING

KSRCE/QM/8.6/22/PDC

(Autonomous)





TIRUCHENGODE - 637 215. TAMILNADU, INDIA.

Approved by AICTE, New Delhi, Anna University, Chennai & Accredited by NBA and NAAC with 'A' Grade

Professionals Development Cell

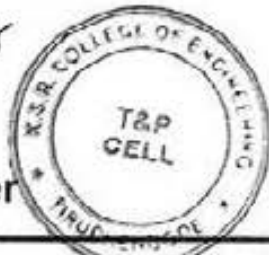
Certificate of Participation

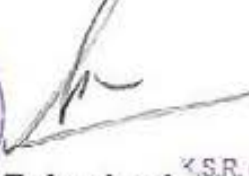
This is to certify that Mr./Ms.....KIRAN.....N......
 of COMPUTER SCIENCE AND ENGINEERING.....department has participated in the
APTITUDE TRAINING PROGRAMME.....
 programme held at TRAINING AND PLACEMENT CELL - KSRCE.....
 on 20.10.21-26.10.21. We wish the student all success.

Date: 26.10.2021  Organizer  Co-ordinator   Principal  

PRINCIPAL
 K.S.R. COLLEGE OF ENGINEERING
 K.S.R. KALVI NAGAR,
 TIRUCHENGODE - 637 215



HIGHER EDUCATIONAL CELL





KSRCE/QM/8.6/22/PDC

K.S.R. COLLEGE OF ENGINEERING

(Autonomous)

TIRUCHENGODE - 637 215, TAMILNADU, INDIA

Approved by AICTE, New Delhi, Anna University, Chennai & Accredited by NBA and NAAC with 'A' Grade

Professionals Development Cell

Certificate of Participation

This is to certify that Mr./Ms. DHARUN M.
of COMPUTER SCIENCE AND ENGINEERING department has participated in the
APTITUDE TRAINING PROGRAMME
programme held at TRAINING AND PLACEMENT CELL - KSRCE
on 20.10.21 - 26.10.21 We wish the student all success.

Date: 26.10.2021

Organizer

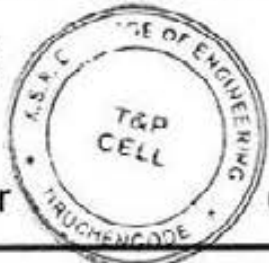

Co-ordinator



Principal



PRINCIPAL
K.S.R. COLLEGE OF ENGINEERING
K.S.R. KALVI NAGAR,
TIRUCHENGODE - 637 215



HIGHER EDUCATIONAL CELL





K.S.R. COLLEGE OF ENGINEERING

(Autonomous)

TIRUCHENGODE - 637 215. TAMILNADU, INDIA

Approved by AICTE, New Delhi, Anna University, Chennai & Accredited by NBA and NAAC with 'A' Grade

Professionals Development Cell

Certificate of Participation

This is to certify that Mr./Ms..... ARUN A.P.....
 of COMPUTER SCIENCE AND ENGINEERING..... department has participated in the
APTITUDE TRAINING PROGRAMME.....
 programme held at TRAINING AND PLACEMENT CELL - KSRCE.....
 on 20.10.21 - 26.10.21. We wish the student all success.

Date: 26.10.2021

S. Ganapathy
Organizer

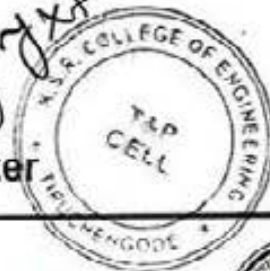

G.S.
Co-ordinator



[Signature]
Principal

[Signature]
PRINCIPAL
K.S.R. COLLEGE OF ENGINEERING
K.S.R. KALVI NA
TIRUCHENGODE - 637 215



HIGHER EDUCATIONAL CELL



2021-2022

(12)

KSRCE/QM/5.5.3/01/2021-22/TP

K.S.R. COLLEGE OF ENGINEERING, TIRUCHENGODE – 637 215
(Autonomous)

DATE: 23-10-2021

TIME: 03.00 p.m.

CIRCULAR

CLASSIFICATION	ROUTINE	IMMEDIATE
ORIGINATOR: PRINCIPAL		CIRCULATED TO: MBA HoD

Sub.: Aptitude Training Program for MBA Students (2023 Batch) of - Reg.

Aptitude Training Program for IT Third Year (2023 Batch) has been organized from **27th October 2021** to **02nd November 2021** (05 Days). The morning session will be conducted from **09.30 am to 12.30 pm**, the afternoon session will be from **01.30 pm to 04.00 pm** and assessment will be conducted from **04.30 pm to 06.00 pm**. So, all the regular classes will be cancelled for the training program. Concerned HoD is requested to instruct their students to be in physical mode (offline mode) and attend the whole training without fail.

Instructions to the Faculty through HoDs

MBA Department T&P Co-ordinator are requested to monitor the attendance & discipline matters throughout the training program and update the HoDs concerned every day.

Instructions to the Students through Department T&P Co-ordinators & HoDs

1. Discipline
 2. Punctuality
 3. All students must wear mask and follow Standard Operating Procedure (SOP) to maintain Covid free campus.
- If any student not follows the above, he/she may not be allowed to proceed further in the process.

PRINCIPAL

Copy to:

1. MBA HoD for favor of information and circulation among current Third year students and faculty members concerned.
2. All Training & Placement Coordinators.
3. Department Notice board.

EVIDENCE OF COMPLETION

Number of persons not received / seen: - _____

Signature of Originator with date and time: _____



PRINCIPAL
K.S.R. COLLEGE OF ENGINEERING
K.S.R. KANNIYAGAR
TIRUCHENGODE-637 215

KSR College of Engineering (Autonomous), Tiruchengode – 637 215

Training and Placement Cell

Phase – 1 Aptitude Training Schedule for 2023 Batch

Date	FN	AN	
13.12.2021	Number System	Average	Assessment and Discussion
14.12.2021	Percentage	Profit and Loss	Assessment and Discussion
15.12.2021	Ratio Proportions	Problems on Ages	Assessment and Discussion
16.12.2021	Time Speed and Distance	Time and Work	Assessment and Discussion
17.12.2021	Permutation and Combination	Probability	Assessment and Discussion
18.12.2021	Blood Relation, Syllogism	Directions, Coding and Decoding	Assessment and Discussion

FN Session

9.30 am to 12.30 pm

AN Session

01.30 pm to 04.00 pm

Assessment

04.30 pm to 06.00 pm

*10.46 am – 11.00am - Break

*12.30 pm – 01.30 pm -Lunch Break

* 02.46 pm – 03.00 pm – Break

S. Gnanapriya
13 Dec 21



PRINCIPAL
K.S.R. COLLEGE OF ENGINEERING
K.S.R. KALVI NAGAR,
TIRUCHENGODE-637 215

K.S.R. COLLEGE OF ENGINEERING(Autonomous), TIRUCHENGODE - 637 215
 TRAINING & PLACEMENT CELL
 MBA, MCA FINAL YEAR STUDENTS 2021-2022 BATCH
 APTTIDUTE INTERNAL TRAINING (27.10.2021 to 02.11.2021)

S.No	Reg No	Name	Branch	27.10.21		28.10.21		29.10.21		01.11.21		02.11.21	
				FN	AN	FN	AN	FN	AN	FN	AN	FN	AN
1	2061002	AKSHAYARAGHAVIE S	MBA	P	P	P	P	P	P	A	A	P	P
2	2061003	ANASH MOHAMED A	MBA	P	P	P	P	P	P	P	P	P	P
3	2061009	DHARMESHWARAN S	MBA	P	P	P	P	P	P	P	P	P	P
4	2061010	DILEEP KUMAR S	MBA	P	P	P	P	P	P	P	P	P	P
5	2061011	JANCY M	MBA	P	P	P	P	P	P	P	P	P	P
6	2061013	KAVIYA S	MBA	P	P	A	A	P	P	P	P	P	P
7	2061014	KOWSALYA M	MBA	P	P	P	P	P	P	P	P	P	P
8	2061015	MITHRA T	MBA	P	P	P	P	P	P	P	P	P	P
9	2061016	PARANIARASU A V P	MBA	P	P	P	P	P	P	P	P	P	P
10	2061017	PAVITHRA V	MBA	P	P	A	A	A	A	A	A	A	A
11	2061019	RUPESH V R	MBA	P	P	P	P	P	P	P	P	P	P
12	2061020	RUTHRAPRIYAN P	MBA	P	P	P	P	P	P	P	P	A	A
13	2061021	SATHISWARAN R	MBA	P	P	P	P	P	P	P	P	P	P
14	2061022	SHAIJU S	MBA	P	P	P	P	P	P	A	A	A	A
15	2061023	SILUVAIJERIN A	MBA	P	P	P	P	P	P	P	P	P	P
16	2061024	SIVARANJANI B	MBA	P	P	P	P	P	P	P	P	P	P
17	2061025	SUBASH S	MBA	P	P	P	P	P	P	P	P	P	P
18	2061027	SUJITH A	MBA	A	A	A	A	A	A	P	P	P	P
19	2061028	SUPRAJA G	MBA	P	P	P	P	P	P	P	P	P	P
20	2061029	TAMILARASAN M A	MBA	P	P	P	P	P	P	P	P	P	P
21	2061030	VINOTH KUMAR M	MBA	P	P	A	A	A	A	A	A	A	A
TOTAL				21	21	21	21	21	21	21	21	21	21
PRESENT				20	20	17	17	18	18	18	18	17	17
ABSENT				1	1	4	4	3	3	3	3	4	4
PLACEMENT CO ORDINATOR SIGN				[Signatures]									
HOD SIGN				[Signatures]									
TRAINING OFFICER				[Signatures]									
PRINCIPAL				[Signatures]									



PRINCIPAL
 K.S.R. COLLEGE OF ENGINEERING
 K.S.R. KALVI NAGAR,
 TIRUCHENGODE-637 215

KSR College of Engineering (Autonomous), Tiruchengode – 637 215

Training and Placement Cell

Phase – 1 Aptitude Training Schedule for 2023 Batch

Date	FN	AN
27.10.2021	Number System	Average
28.10.2021	Percentage	Profit and Loss
29.10.2021	Ratio Proportions	Problems on Ages
01.11.2021	Time Speed and Distance	Time and Work
02.11.2021	Permutation and Combination	Probability

FN Session

9.30 am to 12.30 pm

AN Session

01.30 pm to 04.00 pm

Assessment

04.30 pm to 06.00 pm

*10.46 am – 11.00am - Break

*12.30 pm – 01.30 pm -Lunch Break

* 02.46 pm – 03.00 pm – Break



PRINCIPAL,
K.S.R. COLLEGE OF ENGINEERING
K.S.R. KALVI NAGAR,
TIRUCHENGODE-637 215



KSRCE/QM/8.6/22/PDC

K.S.R. COLLEGE OF ENGINEERING

(Autonomous)





TIRUCHENGODE - 637 215 TAMIL NADU, INDIA.

Approved by AICTE, New Delhi, Anna University, Chennai & Accredited by NBA and NAAC with 'A' Grade

Professionals Development Cell

Certificate of Participation

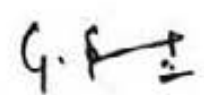
This is to certify that Mr./Ms..... SUBASH S......
 of MASTER OF BUSINESS AND ADMINISTRATION..... department has participated in the
APTITUDE TRAINING
 programme held at TRAINING AND PLACEMENT CELL - KSRCE
 on 27.10.21 - 22.11.21. We wish the student all success.

Date: 02.11.2021  Organizer 
 Co-ordinator 
 Principal  
 K.S.R. COLLEGE OF ENGINEERING
 K.S.R. KALVI NAGAR
 TIRUCHENGODE-637 215



HIGHER EDUCATIONAL CELL





K.S.R. COLLEGE OF ENGINEERING

(Autonomous)

TIRUCHENGODE - 637 215, TAMILNADU, INDIA.

Approved by AICTE, New Delhi, Anna University, Chennai & Accredited by NBA and NAAC with 'A' Grade

Professionals Development Cell

Certificate of Participation

This is to certify that ~~Mr./Ms.~~.....MITHRA . T.....
 of MASTER OF BUSSINESS AND ADMINISTRATION.....department has participated in the
APTITUDE TRAINING.....
 programme held atTRAINING AND PLACEMENT CELL - KSRCE.....
 on ~~27.10.21 - 02.11.21~~... We wish the student all success.

Date: 02.11.2021

S. Manjyxx
Organizer



G. P. S.
Co-ordinator



[Signature]
Principal

PRINCIPAL
K.S.R. COLLEGE OF ENGINEERING
K.S.R. KALVI NAGAR
TIRUCHENGODE-637 215



HIGHER EDUCATIONAL CELL





K.S.R. COLLEGE OF ENGINEERING

(Autonomous)

TIRUCHENGODE - 637 215. TAMILNADU, INDIA.

Approved by AICTE, New Delhi, Anna University, Chennai & Accredited by NBA and NAAC with 'A' Grade

Professionals Development Cell

Certificate of Participation

This is to certify that Mr./Ms. JANCY M
 of MASTER OF BUSINESS AND ADMINISTRATION department has participated in the
APTITUDE TRAINING
 programme held at TRAINING AND PLACEMENT CELL - KSRCE
 on 27.10.21 - 02.11.21. We wish the student all success.

Date: 02.11.2021

[Signature]
Organizer

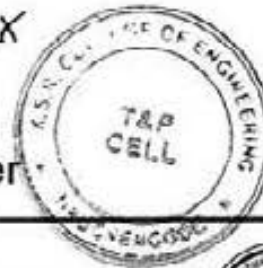

[Signature]
Co-ordinator



[Signature]
Principal
K.S.R. COLLEGE OF ENGINEERING
K.S.R. KALVI NAGAR,
TIRUCHENGODE-637 215



HIGHER EDUCATIONAL CELL





KSRCE/QM/8.6/22/PDC

K.S.R. COLLEGE OF ENGINEERING

(Autonomous)

TIRUCHENGODE - 637 215 TAMILNADU, INDIA

Approved by AICTE, New Delhi, Anna University, Chennai & Accredited by NBA and NAAC with 'A' Grade

Professionals Development Cell

Certificate of Participation

This is to certify that ~~Mr.~~/Ms. CHITRA S.....
of INFORMATION TECHNOLOGY..... department has participated in the
..... TRAINING PROGRAMME.....
programme held at TRAINING AND PLACEMENT CELL - KSRCE.....
on 23.2.22 - 10.3.22 . We wish the student all success.

Date: 10.03.2022

Organizer

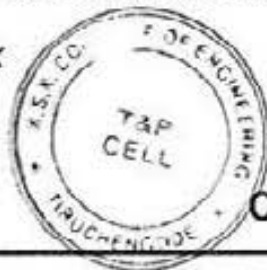

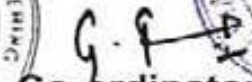
Co-ordinator



Principal
K.S.R. COLLEGE OF ENGINEERING
K.S.R. KALVI NAGAR,
TIRUCHENGODE-637 215



HIGHER EDUCATIONAL CELL



2021-2022
13

KSRCE/QM/5.5.3/01/2021-22/TP18

K.S.R. COLLEGE OF ENGINEERING, TIRUCHENGODE - 637 215
(Autonomous)

DATE: 05-11-2021

TIME: 03.00 p.m.

CIRCULAR

CLASSIFICATION	ROUTINE	IMMEDIATE
ORIGINATOR: PRINCIPAL		CIRCULATED TO: CSE HoD

Sub.: Training Program for Third Year Students (2023 Batch) of CSE (Batch 2) - Reg.

Aptitude Training Program for CSE (Batch 2) Third Year (2023 Batch) has been organized from 08th November 2021 to 13th November 2021 (06 Days). The morning session will be conducted from 09.30 am to 12.30 pm, the afternoon session will be from 01.30 pm to 04.00 pm and assessment will be conducted from 04.30 pm to 06.00 pm. So, all the regular classes will be cancelled for the training program. Concerned HoD is requested to instruct their students to be in physical mode (offline mode) and attend the whole training without fail.

Instructions to the Faculty through HoDs

CSE Department T&P Co-ordinator is requested to monitor the attendance & discipline matters throughout the training program and update the HoDs concerned every day.

Instructions to the Students through Department T&P Co-ordinators & HoD

1. Discipline
2. Punctuality
3. All students must wear mask and follow Standard Operating Procedure (SOP) to maintain Covid free campus. If any student not follows the above, he/she may not be allowed to proceed further in the process.



PRINCIPAL

Copy to:

1. CSE HOD for favor of information and circulation among current Third year students and faculty members concerned.
2. All Training & Placement Coordinators.
3. Department Notice board.

EVIDENCE OF COMPLETION

Number of persons not received / seen: - _____
Signature of Originator with date and time: _____



PRINCIPAL
K.S.R. COLLEGE OF ENGINEERING
K.S.R. KALVI NAGAR,
TIRUCHENGODE-637 215

K.S.R. COLLEGE OF ENGINEERING (AUTONOMOUS), TIRUCHENGODE - 637 215

TRAINING AND PLACEMENT

APTITUDE (INTERNAL) TRAINING CSE THIRD YEAR ATTENDANCE DETAILS -2023 BATCH

S. No	REG NO	NAME	BRANCH	DATE	08.11.2021		09.11.2021		10.11.2021		11.11.2021		12.11.2021		13.11.2021	
				SESSION	FN	AN	FN	AN	FN	AN	FN	AN	FN	AN	FN	AN
				BATCH												
1	1913055	MOHAMED ISMAIL SHEREEF N	CSE	BATCH 2	/	/	/	/	/	/	/	/	a	a	/	/
2	1913056	MUGESH G	CSE	BATCH 2	/	/	/	/	/	/	a	a	a	a	/	/
3	1913057	MYTHILIT	CSE	BATCH 2	/	/	/	/	/	/	/	/	/	/	/	/
4	1913059	NAVEENKUMAR N	CSE	BATCH 2	/	/	/	/	/	/	/	/	/	/	/	/
5	1913060	NIRMAL KUMAR M	CSE	BATCH 2	/	/	/	/	/	/	a	a	/	/	a	a
6	1913061	NIRMALA C	CSE	BATCH 2	/	/	/	/	/	/	/	/	/	/	/	/
7	1913062	NITHEESH KUMAR C	CSE	BATCH 2	/	/	/	/	OD	OD	a	a	OD	OD	OD	OD
8	1913063	NIVETHA M	CSE	BATCH 2	/	/	/	/	/	/	/	/	/	/	/	/
9	1913064	PAVITHRA M	CSE	BATCH 2	/	/	/	/	/	/	/	/	/	/	/	/
10	1913065	PAVITHRA V	CSE	BATCH 2	/	/	a	a	/	/	/	/	/	/	/	/
11	1913066	PRADEEP S	CSE	BATCH 2	/	/	/	/	/	/	/	/	/	/	/	/
12	1913067	PRANITHA. K	CSE	BATCH 2	/	/	/	/	/	/	/	/	/	/	/	/
13	1913068	PRATHAP.S	CSE	BATCH 2	/	/	/	/	/	/	/	/	/	/	/	/
14	1913069	PRAVEENTH R	CSE	BATCH 2	/	/	/	/	/	/	/	/	/	/	/	/
15	1913070	PREMALA J	CSE	BATCH 2	/	/	/	/	/	/	/	/	/	/	/	/
16	1913071	RAAGHAVI. V	CSE	BATCH 2	/	/	/	/	/	/	/	/	/	/	/	a
17	1913072	RAGU BALAN R	CSE	BATCH 2	/	/	/	/	/	/	/	/	/	/	/	/
18	1913073	RAMYA P	CSE	BATCH 2	/	/	/	/	/	/	/	/	/	/	/	/
19	1913074	RANJETH ASWIN R	CSE	BATCH 2	/	/	/	/	a	a	/	/	OD	OD	a	a
20	1913075	V.RESHMA	CSE	BATCH 2	/	/	/	/	/	/	/	/	/	/	/	/
21	1913076	RITHIKA K	CSE	BATCH 2	/	/	/	/	/	/	/	/	OD	OD	/	/
22	1913077	SABARINA S	CSE	BATCH 2	/	/	/	/	/	/	/	/	/	/	/	/
23	1913078	S.SAKTHIVEL	CSE	BATCH 2	/	/	/	/	a	a	/	/	/	/	/	/
24	1913079	J.samuel	CSE	BATCH 2	/	/	/	/	/	/	/	/	/	/	/	/
25	1913080	SANJAI T	CSE	BATCH 2	/	/	/	/	/	/	/	/	/	/	/	/
26	1913081	SANJAY.K	CSE	BATCH 2	/	/	/	/	/	/	/	/	a	a	a	a
27	1913082	SANJAI KUMAR E	CSE	BATCH 2	/	/	/	/	/	/	/	/	/	/	/	/
28	1913083	Sanjeevi.N.A	CSE	BATCH 2	/	/	/	/	/	/	/	/	Late	/	/	/

16.11.21 11.11.21 12.11.21 13.11.21

29	1913084	SARAN S B	CSE	BATCH 2	/	/	/	/	/	/	/	/	00	/	/	/
30	1913085	P.SEENIVASAN	CSE	BATCH 2	/	/	/	/	a	a	/	/	/	/	/	/
31	1913087	SHEKAR R D	CSE	BATCH 2	/	/	/	/	/	/	/	/	/	/	/	/
32	1913088	N.SIRAGIRIVELAN	CSE	BATCH 2	/	/	/	/	/	/	/	/	/	/	/	/
33	1913089	SRI HARI V	CSE	BATCH 2	/	/	/	/	/	/	/	/	/	/	/	/
34	1913090	SRINATH T	CSE	BATCH 2	/	/	/	/	/	/	/	/	/	/	/	/
35	1913091	SRISHANGAR M	CSE	BATCH 2	/	/	/	/	/	/	/	/	/	/	a	a
36	1913092	Subramani p	CSE	BATCH 2	/	/	a	a	/	/	a	a	a	a	a	a
37	1913093	M. SURUTHI	CSE	BATCH 2	/	/	/	/	/	/	/	/	/	/	/	/
38	1913094	SURYA M	CSE	BATCH 2	/	/	/	/	/	/	/	/	/	/	/	/
39	1913095	SURYA S	CSE	BATCH 2	/	/	/	/	/	/	/	/	/	/	/	/
40	1913097	SWETHA.G.A.	CSE	BATCH 2	/	/	/	/	/	/	/	/	/	/	/	/
41	1913098	Tharaga prasath J	CSE	BATCH 2	/	/	/	/	/	/	/	/	/	/	/	/
42	1913099	S. Udhaya Prakash	CSE	BATCH 2	a	a	/	/	/	/	/	/	/	/	/	/
43	1913100	VANAJA.R	CSE	BATCH 2	/	/	/	/	/	/	/	/	/	/	/	/
44	1913101	Vibish s b	CSE	BATCH 2	/	/	/	/	/	/	/	/	/	/	/	/
45	1913103	VIJAY. M	CSE	BATCH 2	/	/	/	/	/	/	/	/	/	/	/	/
46	1913104	VIJAY P	CSE	BATCH 2	a	a	/	/	/	01	/	/	/	/	/	/
47	1913105	VISHNU K	CSE	BATCH 2	/	/	/	/	a	a	/	/	/	/	/	/
48	1913106	YAAZHINI P	CSE	BATCH 2	/	/	/	/	/	/	/	/	/	/	/	/
49	1913107	YAVANIKA.V	CSE	BATCH 2	/	/	/	/	/	/	/	/	/	/	/	/
50	1913505	SATHISH P	CSE	BATCH 2	/	/	/	/	a	a	/	/	/	/	/	/
51	1913506	SHIVARAJA .M	CSE	BATCH 2	/	/	/	/	/	/	/	/	a	a	/	/
52	1913507	SOUNDHIRARAJAN.C	CSE	BATCH 2	/	/	/	/	/	/	/	/	/	/	/	/
53	1913508	A. SURYAKUMAR	CSE	BATCH 2	/	/	/	/	/	/	/	/	/	/	/	/
54	1913510	U.VIGNESH	CSE	BATCH 2	/	/	/	/	/	/	/	/	a	a	/	/
TOTAL					54	54	54	54	54	54	54	54	54	54	54	54
PRESENT					52	52	52	52	49	49	50	50	48	48	49	48
ABSENT					02	02	02	02	05	05	04	04	06	06	05	06
PLACEMENT CO ORDINATOR SIGN					<i>[Signature]</i>	<i>[Signature]</i>	<i>[Signature]</i>	<i>[Signature]</i>	<i>[Signature]</i>	<i>[Signature]</i>	<i>[Signature]</i>	<i>[Signature]</i>	<i>[Signature]</i>	<i>[Signature]</i>	<i>[Signature]</i>	<i>[Signature]</i>
HOD SIGN					<i>[Signature]</i>	<i>[Signature]</i>	<i>[Signature]</i>	<i>[Signature]</i>	<i>[Signature]</i>	<i>[Signature]</i>	<i>[Signature]</i>	<i>[Signature]</i>	<i>[Signature]</i>	<i>[Signature]</i>	<i>[Signature]</i>	<i>[Signature]</i>
TRAINING OFFICER					<i>[Signature]</i>	<i>[Signature]</i>	<i>[Signature]</i>	<i>[Signature]</i>	<i>[Signature]</i>	<i>[Signature]</i>	<i>[Signature]</i>	<i>[Signature]</i>	<i>[Signature]</i>	<i>[Signature]</i>	<i>[Signature]</i>	<i>[Signature]</i>
PRINCIPAL					<i>[Signature]</i>	<i>[Signature]</i>	<i>[Signature]</i>	<i>[Signature]</i>	<i>[Signature]</i>	<i>[Signature]</i>	<i>[Signature]</i>	<i>[Signature]</i>	<i>[Signature]</i>	<i>[Signature]</i>	<i>[Signature]</i>	<i>[Signature]</i>

PRINCIPAL
K.S.R. COLLEGE OF ENGINEERING
K.S.R. KALVI NAGAR,
TIRUCHENGOORUR

KSR College of Engineering (Autonomous), Tiruchengode – 637 215

Training and Placement Cell

Phase – 1 Aptitude Training Schedule for 2023 Batch

Date	FN	AN
08.11.2021	Number System	Average
09.11.2021	Percentage	Profit and Loss
10.11.2021	Ratio Proportions	Problems on Ages
11.11.2021	Time Speed and Distance	Time and Work
12.11.2021	Permutation and Combination	Probability
13.11.2021	Blood Relation, Syllogism	Directions, Coding and Decoding

FN Session

9.30 am to 12.30 pm

AN Session

01.30 pm to 04.00 pm

Assessment

04.30 pm to 06.00 pm

*10.46 am – 11.00am - Break

*12.30 pm – 01.30 pm -Lunch Break

* 02.46 pm – 03.00 pm – Break

S. Srinivasan
8 Nov 22



PRINCIPAL
K.S.R. COLLEGE OF ENGINEERING
K.S.R. KALVINAGAR,
TIRUCHENGODE-637 215



KSRCE/QM/8.6/22/PDC

K.S.R. COLLEGE OF ENGINEERING

(Autonomous)

TIRUCHENGODE 637 215.TAMILNADU, INDIA.

Approved by AICTE, New Delhi, Anna University, Chennai & Accredited by NBA and NAAC with 'A' Grade

Professionals Development Cell

Certificate of Participation

This is to certify that Mr./Ms.....VITAY M......
 of COMPUTER SCIENCE AND ENGINEERING.....department has participated in the
APTITUDE TRAINING PROGRAMME.....
 programme held atTRAINING AND PLACEMENT CELL - KSRCE.....
 on 8.11.21 - 13.11.2021. We wish the student all success.

Date: 13.11.2021

S. Pragna
 Organizer

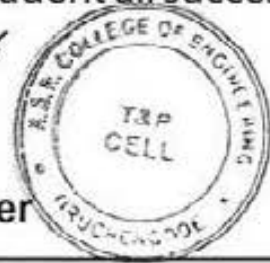

G. S. S.
 Co-ordinator



[Signature]
 Principal

PRINCIPAL
 K.S.R. COLLEGE OF ENGINEERING
 K.S.R. KALVI NAGAR
 TIRUCHENGODE-637 215



HIGHER EDUCATIONAL CELL





KSRCE/QM/8.6/22/PDC

K.S.R. COLLEGE OF ENGINEERING

(Autonomous)

TIRUCHENGODE - 637 215. TAMILNADU, INDIA.

Approved by AICTE, New Delhi, Anna University, Chennai & Accredited by NBA and NAAC with 'A' Grade

Professionals Development Cell

Certificate of Participation

This is to certify that Mr./Ms. PAVITARA M.
 of COMPUTER SCIENCE AND ENGINEERING department has participated in the
APTITUDE TRAINING PROGRAMME
 programme held at TRAINING AND PLACEMENT CELL - KSRCE
 on 8.11.21 - 13.11.2021. We wish the student all success.

Date: 13.11.2021

[Signature]
 Organizer



[Signature]
 Co-ordinator

[Signature]
 Principal

PRINCIPAL
 K.S.R. COLLEGE OF ENGINEERING
 K.S.R. KALVI ROAD,
 TIRUCHENGODE - 637 215



HIGHER EDUCATIONAL CELL





KSRCE/QM/8.6/22/PDC

K.S.R. COLLEGE OF ENGINEERING

(Autonomous)

TIRUCHENGODE - 637 215. TAMILNADU, INDIA.

Approved by AICTE, New Delhi, Anna University, Chennai & Accredited by NBA and NAAC with 'A' Grade

Professionals Development Cell

Certificate of Participation

This is to certify that Mr./Ms.....NITHEESH KUMAR : C.....
of COMPUTER SCIENCE AND ENGINEERING..... department has participated in the
.....APTITUDE TRAINING PROGRAMME.....
programme held at TRAINING AND PLACEMENT CELL - KSRCE.....
on 12.11.21 - 13.11.2021. We wish the student all success.

Date: 13.11.2021

[Signature]
Organizer



[Signature]
Co-ordinator



[Signature]
Principal

PRINCIPAL
K.S.R. COLLEGE OF
K.S.R. KALVI
TIRUCHENGODE



HIGHER EDUCATIONAL CELL



GINEE GAR, 37 21



K.S.R. COLLEGE OF ENGINEERING

KSRCE/QM/8.6/22/PDC

(Autonomous)

TIRUCHENGODE - 637 215 TAMILNADU, INDIA

Approved by AICTE, New Delhi, Anna University, Chennai & Accredited by NBA and NAAC with 'A' Grade

Professionals Development Cell

Certificate of Participation

This is to certify that Mr./Ms. SARAN. S.B.
 of COMPUTER SCIENCE AND ENGINEERING department has participated in the
APTITUDE TRAINING PROGRAMME
 programme held at TRAINING AND PLACEMENT CELL - KSRCE
 on 8.11.21 - 13.11.21. We wish the student all success.

Date: 13.11.2021

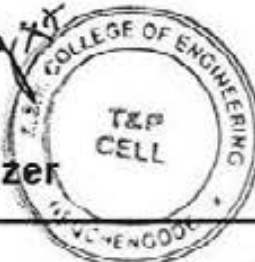
 Organizer



 Co-ordinator



 Principal
 PRINCIPAL
 K.S.R. COLLEGE OF ENGINEERING
 K.S.R. KALVI NAGAR
 TIRUCHENGODE-637 215



HIGHER EDUCATIONAL CELL



K.S.R. COLLEGE OF ENGINEERING, TIRUCHENGODE – 637 215
(Autonomous)

DATE: 30-11-2021

TIME: 04.00 p.m.

CIRCULAR

CLASSIFICATION	ROUTINE	IMMEDIATE
ORIGINATOR: PRINCIPAL		CIRCULATED TO: EEE & ECE HoDs

Sub.: Aptitude Training Program for Third Year Students (2023 Batch) of EEE & ECE (Batch 3) - Reg.

Aptitude Training Program for EEE & ECE (Batch 3) Third Year (2023 Batch) has been organized from 06th December 2021 to 11th December 2021 (06 Days). The morning session will be conducted from 09.30 am to 12.30 pm, the afternoon session will be from 01.30 pm to 04.00 pm and assessment will be conducted from 04.30 pm to 06.00 pm. So, all the regular classes will be cancelled for the training program. Concerned HoDs are requested to instruct their students to be in physical mode (offline mode) and attend the whole training without fail.

Instructions to the Faculty through HoDs

EEE & ECE Department T&P Co-ordinators are requested to monitor the attendance & discipline matters throughout the training program and update the concerned HoDs every day.

Instructions to the Students through Department T&P Co-ordinators & HoDs

1. Discipline
 2. Punctuality
 3. All students must wear mask and follow Standard Operating Procedure (SOP) to maintain Covid free campus.
- If any student not follows the above, he/she may not be allowed to proceed further in the process.

G. P. S. Sathish
TRAINING & PLACEMENT OFFICER
K.S.R. COLLEGE OF ENGINEERING
TIRUCHENGODE - 637 215.

P. M.
PRINCIPAL

Copy to:

1. EEE & ECE HoDs for favor of information and circulation among current Third year students and faculty members concerned.
2. All Training & Placement Coordinators.
3. Department Notice board.

EVIDENCE OF COMPLETION

Number of persons not received / seen: _____

Signature of Originator with date and time: _____



P. M.
PRINCIPAL
K.S.R. COLLEGE OF ENGINEERING
K.S.R. KALVI NAGAR,
TIRUCHENGODE-637 215

KSR College of Engineering (Autonomous), Tiruchengode – 637 215

Training and Placement Cell

Phase – 1 Aptitude Training Schedule for 2023 Batch

Date	FN	AN	
06.12.2021	Number System	Average	Assessment and Discussion
07.12.2021	Percentage	Profit and Loss	Assessment and Discussion
08.12.2021	Ratio Proportions	Problems on Ages	Assessment and Discussion
09.12.2021	Time Speed and Distance	Time and Work	Assessment and Discussion
10.12.2021	Permutation and Combination	Probability	Assessment and Discussion
11.12.2021	Blood Relation, Syllogism	Directions, Coding and Decoding	Assessment and Discussion

FN Session

9.30 am to 12.30 pm

AN Session

01.30 pm to 04.00 pm

Assessment

04.30 pm to 06.00 pm

*10.46 am – 11.00am - Break

*12.30 pm – 01.30 pm -Lunch Break

* 02.46 pm – 03.00 pm – Break



PRINCIPAL
K.S.R. COLLEGE OF ENGINEERING
K.S.R. KALVI NAGAR,
TIRUCHENGODE-637 215

K.S.R. COLLEGE OF ENGINEERING (AUTONOMOUS), TIRUCHENGODE - 637 215

TRAINING AND PLACEMENT

APTITUDE (INTERNAL) TRAINING ECE ATTENDANCE DETAILS -2023 BATCH

S. No	REG NO	NAME	DATE	06.12.2021		07.12.2021		08.12.2021		09.12.2021		10.12.2021		11.12.2021	
				FN	AN	FN	AN	FN	AN	FN	AN	FN	AN	FN	AN
			BRANCH												
1	1915002	ARAVINTHAN T	ECE	P	P	P	P	P	P	P	P	P	P	A	A
2	1915003	ARUNKUMAR S	ECE	P	P	P	P	P	P	P	P	P	P	P	P
3	1915004	ASHOKKUMAR K	ECE	P	P	P	P	P	P	P	P	P	P	A	A
4	1915006	DINESH S	ECE	P	P	P	P	P	P	P	P	P	P	P	P
5	1915007	DINESHKUMAR T	ECE	P	P	P	P	P	P	P	P	P	P	P	P
6	1915008	DIWAHAR S J	ECE	P	P	P	P	P	P	P	P	P	P	P	P
7	1915009	GOWRIMANOHARI S	ECE	P	P	P	P	P	P	P	P	P	P	P	P
8	1915010	GOWTHAM R	ECE	P	P	P	P	P	P	P	P	P	P	P	P
9	1915011	ILAVARASAN K	ECE	P	P	P	P	P	P	P	P	P	P	A	A
10	1915012	INDUMATHI J	ECE	P	P	P	P	P	P	P	P	P	P	P	P
11	1915013	JAGADEEP S	ECE	P	P	P	P	P	P	P	P	P	P	P	P
12	1915014	JAWAHAR DHANUSH A	ECE	P	P	P	P	P	P	P	P	P	P	A	A
13	1915015	JAYAPRAKASH. M	ECE	P	P	P	P	P	P	P	P	P	P	P	P
14	1915016	JEEVANANDHAM.C.P	ECE	P	P	P	P	P	P	P	P	P	P	P	P
15	1915017	KALIDAS M	ECE	P	P	P	P	P	P	P	P	A	A	P	P
16	1915019	KARTHIKA DEVI. K	ECE	P	P	P	P	P	P	P	P	P	P	P	P
17	1915020	KAVIN M	ECE	P	P	P	P	P	P	P	P	P	P	P	P
18	1915021	KAVINESH K	ECE	P	P	P	P	P	P	P	P	P	P	P	P
19	1915022	KAVINMUTHU S	ECE	P	P	P	P	P	P	P	P	P	P	P	P
20	1915024	KIRANRAJ T	ECE	P	P	P	P	P	P	P	P	P	P	P	P
21	1915025	KISHORE D	ECE	P	P	P	P	P	P	P	P	P	P	P	P
22	1915026	KUMAR.S	ECE	P	P	P	P	P	P	P	P	P	P	P	P
23	1915027	LINGESH S	ECE	P	P	P	P	P	P	P	P	P	P	A	A
24	1915028	LOGESH S D	ECE	P	P	P	P	P	P	P	P	P	P	P	P
25	1915029	LOKENDRAN.S	ECE	P	P	P	P	P	P	P	P	P	P	P	P
26	1915030	MAGIBALAN R	ECE	P	P	P	P	P	P	P	P	P	P	P	P
27	1915032	MANOJ T	ECE	P	P	P	P	P	P	P	P	P	P	P	P



28	1915033	MOHAN S	ECE	P	P	P	P	P	P	P	P	P	P	P	P	P	
29	1915034	Mohanaselvan.D.V	ECE	P	P	P	P	P	P	P	P	P	P	P	P	P	
30	1915035	MOHANPRASATH.A	ECE	P	P	P	P	P	P	P	P	P	P	P	P	P	
TOTAL				30	30	30	30	30	30	30	30	30	30	30	30	30	
PRESENT				30	30	30	30	30	20	30	30	29	29	25	25		
ABSENT				-	-	-	-	-	-	-	-	1	1	5	5		
PLACEMENT CO ORDINATOR SIGN				<i>ps</i>	<i>ps</i>	<i>ps</i>	<i>ps</i>	<i>ps</i>	<i>ps</i>	<i>ps</i>	<i>ps</i>	<i>ps</i>	<i>ps</i>	<i>ps</i>	<i>ps</i>	<i>ps</i>	
HOD SIGN				<i>ML</i>	<i>ML</i>	<i>ML</i>	<i>ML</i>	<i>ML</i>	<i>ML</i>	<i>ML</i>	<i>ML</i>	<i>ML</i>	<i>ML</i>	<i>ML</i>	<i>ML</i>	<i>ML</i>	
TRAINING OFFICER				<i>S. G. Prasad</i>	<i>S. G. Prasad</i>	<i>S. G. Prasad</i>	<i>S. G. Prasad</i>	<i>S. G. Prasad</i>	<i>S. G. Prasad</i>	<i>S. G. Prasad</i>	<i>S. G. Prasad</i>	<i>S. G. Prasad</i>	<i>S. G. Prasad</i>	<i>S. G. Prasad</i>	<i>S. G. Prasad</i>	<i>S. G. Prasad</i>	<i>S. G. Prasad</i>
PRINCIPAL				<i>[Signature]</i>	<i>[Signature]</i>	<i>[Signature]</i>	<i>[Signature]</i>	<i>[Signature]</i>	<i>[Signature]</i>	<i>[Signature]</i>	<i>[Signature]</i>	<i>[Signature]</i>	<i>[Signature]</i>	<i>[Signature]</i>	<i>[Signature]</i>	<i>[Signature]</i>	

G. P. S.
TRAINING & PLACEMENT OFFICER
 K.S.R. COLLEGE OF ENGINEERING
 TIRUCHENGODE - 637 215.

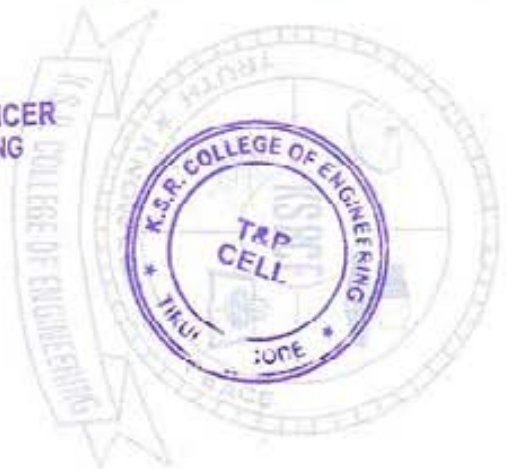

[Signature]
PRINCIPAL
 K.S.R. COLLEGE OF ENGINEERING
 K.S.R. KALVI NAGAR,
 TIRUCHENGODE-637 215.

K.S.R. COLLEGE OF ENGINEERING (AUTONOMOUS), TIRUCHENGODE - 637 215

TRAINING AND PLACEMENT

APTITUDE (INTERNAL) TRAINING EEE ATTENDANCE DETAILS -2023 BATCH

S. No	REG NO	NAME	DATE BRANCH	06.12.2021		07.12.2021		08.12.2021		09.12.2021		10.12.2021		11.12.2021		
				FN	AN	FN	AN	FN	AN	FN	AN	FN	AN	FN	AN	
				1	1914001	ABINAYA	EEE	P	P	P	P	P	P	P	P	P
2	1914002	AMOL	EEE	A	A	A	A	A	A	P	P	P	P	P	P	
3	1914004	CHANDRU	EEE	A	A	P	P	P	P	P	P	P	P	P	P	
4	1914006	DINESH KUMAR	EEE	P	P	P	P	P	P	A	A	A	A	P	P	
5	1914007	DINESHWARAN	EEE	P	P	P	P	P	P	A	A	A	A	P	P	
6	1914008	DIVAKAR	EEE	P	P	P	P	P	P	P	P	P	P	P	P	
7	1914010	HARI GOKUL	EEE	P	P	P	P	P	P	P	P	P	P	P	P	
8	1914013	INFANT JENIFER	FFF	P	P	P	P	P	P	P	P	P	P	P	P	
9	1914016	JEEVITHA	EEE	P	P	P	P	P	P	P	P	P	P	P	P	
10	1914017	KAARTHIKEYAN	EEE	P	P	P	P	P	P	P	P	P	P	P	P	
11	1914018	KABEENA	EEE	P	P	P	P	P	P	P	P	P	P	P	P	
12	1914021	KAVIN	EEE	P	P	P	P	A	A	P	P	P	P	P	P	
13	1914023	KIRUBAKARAN	EEE	A	A	P	P	A	A	P	P	P	P	P	P	
14	1914025	KOWSIKPRABU	EEE	P	P	P	P	P	P	P	P	A	A	A	A	
15	1914026	MOHAMMED AL FAHAD	EEE	P	P	P	P	P	P	P	P	P	P	P	P	
TOTAL				15	15	15	15	15	15	15	15	15	15	15	15	15
PRESENT				12	12	14	14	12	12	13	03	12	12	14	14	
ABSENT				3	3	01	01	03	03	02	02	03	03	01	01	
PLACEMENT CO ORDINATOR SIGN				[Signature]		[Signature]		[Signature]		[Signature]		[Signature]		[Signature]		
HOD SIGN				[Signature]		[Signature]		[Signature]		[Signature]		[Signature]		[Signature]		
TRAINING OFFICER				[Signature]		[Signature]		[Signature]		[Signature]		[Signature]		[Signature]		
PRINCIPAL				[Signature]		[Signature]		[Signature]		[Signature]		[Signature]		[Signature]		

G. P. [Signature]
 TRAINING & PLACEMENT OFFICER
 K.S.R. COLLEGE OF ENGINEERING
 TIRUCHENGODE - 637 215.



[Signature]
 PRINCIPAL
 K.S.R. COLLEGE OF ENGINEERING
 K.S.R. KAI VI NAGAR,
 TIRUCHENGODE-637 215

Sample feedback.

K.S.R. COLLEGE OF ENGINEERING (AUTONOMOUS), TIRUCHENGODE – 637215

TRAINING AND PLACEMENT CELL

STUDENT'S FEEDBACK FORM FOR TRAINING

Name of the Student: GOWRIMANDHARI S Reg. No.: 1915009

Date: 11.12.2021

Year/ Sem : 3 / 5

Dept. : ECE

S. No.	Rate the Following	Trainer 1	Trainer 2	Trainer 3	Trainer 4	Trainer 5
	Trainer Name	K. H. GURUDHARAN				
1	Content & Structure of the Training	4				
2	Clarity of Instructions	5				
3	Delivery of the Content	4				
4	Method of Delivery (Use of Aids)	4				
5	Handouts & Manuals	3				
6	Trainer's Communication	5				
7	Assistance from the Trainer	5				
8	"Hands on" Practice	4				
9	Attainment of Objective	4				
10	Time Management	5				
	Total	43				
	How could this training be improved? (Quality/Quantity of the information presented, type of illustrations used).	Quantity of the information presented, type of illustrations.				
	Mention the additional Training requirement if any.					

Rate the Trainers: Poor – 1, Fair – 2, Good – 3, Very Good – 4, Excellent – 5

Name of the Training Programme:

INTERNAL APTITUDE
TRAINING PHASE - 1

Name of the Training Agency: INTERNAL

Signature of the Student

G. Gowrimanif



PRINCIPAL
K.S.R. COLLEGE OF ENGINEERING
K.S.R. KALVI NAGAR,
TIRUCHENGODE-637 215

K.S.R. COLLEGE OF ENGINEERING (AUTONOMOUS), TIRUCHENGODE - 637215

TRAINING AND PLACEMENT CELL

STUDENT'S FEEDBACK FORM FOR TRAINING

Name of the Student: KAARTHIKEYAN.S

Reg. No.: 1914017

Date: 11.12.2021

Year/ Sem : III / V

Dept. : EEE

S. No.	Rate the Following	Trainer 1	Trainer 2	Trainer 3	Trainer 4	Trainer 5
	Trainer Name	GIRIDHARAN KM				
1	Content & Structure of the Training	5				
2	Clarity of Instructions	5				
3	Delivery of the Content	5				
4	Method of Delivery (Use of Aids)	5				
5	Handouts & Manuals	4				
6	Trainer's Communication	5				
7	Assistance from the Trainer	5				
8	"Hands on" Practice	4				
9	Attainment of Objective	4				
10	Time Management	5				
	Total	47				
How could this training be improved? (Quality/Quantity of the information presented, type of illustrations used).		Teaching some more Example sums in different cases.				
Mention the additional Training requirement if any.						

Rate the Trainers: Poor - 1, Fair - 2, Good - 3, Very Good - 4, Excellent - 5

Name of the Training Programme: Internal aptitude phase-I

Name of the Training Agency:

S. Karanth

Signature of the Student



PRINCIPAL
K.S.R. COLLEGE OF ENGINEERING
K.S.R. KALVI NAGAR,
TIRUCHENGODE-637 215

K.S.R. COLLEGE OF ENGINEERING (AUTONOMOUS), TIRUCHENGODE - 637215

TRAINING AND PLACEMENT CELL

STUDENT'S FEEDBACK FORM FOR TRAINING

Name of the Student: Kiranraj T

Reg. No.: 1915024

Date: 11/12/2022

Year/ Sem : 3rd - IV

Dept. : ECE

S. No.	Rate the Following	Trainer 1	Trainer 2	Trainer 3	Trainer 4	Trainer 5
	Trainer Name	Prinithrasan K.M.				
1	Content & Structure of the Training	5				
2	Clarity of Instructions	5				
3	Delivery of the Content	5				
4	Method of Delivery (Use of Aids)	5				
5	Handouts & Manuals	5				
6	Trainer's Communication	5				
7	Assistance from the Trainer	5				
8	"Hands on" Practice	5				
9	Attainment of Objective	5				
10	Time Management	5				
	Total	45				
How could this training be improved? (Quality/Quantity of the information presented, type of illustrations used).		Improve our delivery style.				
Mention the additional Training requirement if any.						

Rate the Trainers: Poor - 1, Fair - 2, Good - 3, Very Good - 4, Excellent - 5

Name of the Training Programme:

Internal Aptitude
Phase - I

Name of the Training Agency:

T.K. Kalvi
Signature of the Student



[Signature]
PRINCIPAL
K.S.R. COLLEGE OF ENGINEERING
K.S.R. KALVI NAGAR,
TIRUCHENGODE-637 215

K.S.R. COLLEGE OF ENGINEERING (AUTONOMOUS), TIRUCHENGODE – 637215

TRAINING AND PLACEMENT CELL

STUDENT'S FEEDBACK FORM FOR TRAINING

Name of the Student: *R Infant Jenifa*

Reg. No.: *1914013*

Date: *11/12/21*

Year/ Sem : *III / V*

Dept. : *EEE*

S. No.	Rate the Following	Trainer 1	Trainer 2	Trainer 3	Trainer 4	Trainer 5
	Trainer Name	<i>K.M. GIRIDHARAN</i>			<i>4</i>	
1	Content & Structure of the Training	<i>5</i>			<i>✓</i>	
2	Clarity of Instructions	<i>5</i>			<i>✓</i>	
3	Delivery of the Content	<i>5</i>		<i>✓</i>		
4	Method of Delivery (Use of Aids)	<i>5</i>		<i>✓</i>		
5	Handouts & Manuals	<i>4</i>			<i>✓</i>	
6	Trainer's Communication	<i>5</i>			<i>✓</i>	
7	Assistance from the Trainer	<i>4</i>			<i>✓</i>	
8	"Hands on" Practice	<i>5</i>			<i>✓</i>	
9	Attainment of Objective	<i>5</i>			<i>✓</i>	
10	Time Management	<i>5</i>			<i>✓</i>	
	Total	<i>48</i>			<i>4</i>	
	How could this training be improved? (Quality/Quantity of the information presented, type of illustrations used).	<i>MAY Provide some basic handouts & manuals for beginners.</i>				
	Mention the additional Training requirement if any.					

Rate the Trainers: Poor – 1, Fair – 2, Good – 3, Very Good – 4, Excellent – 5

Name of the Training Programme:

Internal Aptitude Training

Phase : 1

Name of the Training Agency: *Internal.*

R. Jifa.

Signature of the Student



[Signature]
PRINCIPAL
K.S.R. COLLEGE OF ENGINEERING
K.S.R. KALVI NAGAR,
TIRUCHENGODE-637 215

KSR College of Engineering (Autonomous), Tiruchengode – 637 215

Training and Placement Cell

Phase – 1 Aptitude Training Schedule for 2023 Batch

Date	FN	AN
06.12.2021	Number System	Average
07.12.2021	Percentage	Profit and Loss
08.12.2021	Ratio Proportions	Problems on Ages
09.12.2021	Time Speed and Distance	Time and Work
10.12.2021	Permutation and Combination	Probability
11.12.2021	Blood Relation, Syllogism	Directions, Coding and Decoding

FN Session

9.30 am to 12.30 pm

AN Session

01.30 pm to 04.00 pm

Assessment

04.30 pm to 06.00 pm

*10.46 am – 11.00am - Break

*12.30 pm – 01.30 pm -Lunch Break

* 02.46 pm – 03.00 pm – Break



PRINCIPAL,
K.S.R. COLLEGE OF ENGINEERING
K.S.R. KALVI NAGAR,
TIRUCHENGODE-637 215



K.S.R. COLLEGE OF ENGINEERING

(Autonomous)

TIRUCHENGODE - 637 215. TAMILNADU, INDIA.

Approved by AICTE, New Delhi, Anna University, Chennai & Accredited by NBA and NAAC with 'A' Grade

Professionals Development Cell

Certificate of Participation

This is to certify that Mr./Ms. JEEVITHA.....
 of ELECTRICAL AND ELECTRONICS ENGINEERING..... department has participated in the
APTITUDE TRAINING.....
 programme held at TRAINING AND PLACEMENT CELL - KSRCE.....
 on 6.12.21 - 11.12.21..... We wish the student all success.

Date: 11.12.2021

S. Srinivasan
Organizer

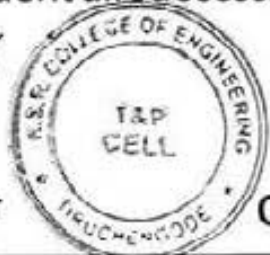

G. Srinivasan
Co-ordinator



[Signature]
Principal
K.S.R. COLLEGE OF ENGINEERING
K.S.R. KALVI NAGAR,
TIRUCHENGODE-637 215



HIGHER EDUCATIONAL CELL





KSRCE/QM/8.6/22/PDC

K.S.R. COLLEGE OF ENGINEERING

(Autonomous)

TIRUCHENGODE - 637 215.TAMILNADU, INDIA.

Approved by AICTE, New Delhi, Anna University, Chennai & Accredited by NBA and NAAC with 'A' Grade

Professionals Development Cell

Certificate of Participation

This is to certify that Mr./Ms..... AMOL.....

of ELECTRICAL AND ELECTRONICS ENGINEERING..... department has participated in the

APTITUDE TRAINING

programme held at TRAINING AND PLACEMENT CELL - KSRCE

on 6.12.21 - 11.12.21.... We wish the student all success.

Date: 11.12.2021

Organizer

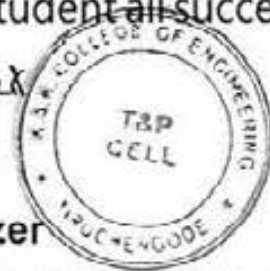

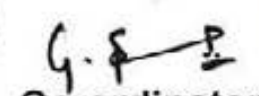
Co-ordinator



Principal

PRINCIPAL
K.S.R. COLLEGE OF ENGINEERING
K.S.R. KALVI NAGAR
TIRUCHENGODE-637 215



HIGHER EDUCATIONAL CELL





K.S.R. COLLEGE OF ENGINEERING

KSRCE/QM/8.6/22/PDC

(Autonomous)

TIRUCHENGODE - 637 215. TAMILNADU, INDIA

Approved by AICTE, New Delhi, Anna University, Chennai & Accredited by NBA and NAAC with 'A' Grade

Professionals Development Cell

Certificate of Participation

This is to certify that Mr./Ms. MANOJ T
 of ELECTRONICS AND COMMUNICATION ENGINEERING department has participated in the
APTITUDE TRAINING
 programme held at TRAINING AND PLACEMENT CELL - KSRCE
 on 6.12.21 - 11.12.21. We wish the student all success.

Date: 11.12.21

S. Srinivas
 Organizer



G. S. P.
 Co-ordinator



h
 Principal

h
 PRINCIPAL
 K.S.R. COLLEGE OF ENGINEERING
 K.S.R. KALVI NAGAR
 TIRUCHENGODE-637 215



HIGHER EDUCATIONAL CELL





K.S.R. COLLEGE OF ENGINEERING

(Autonomous)

TIRUCHENGODE - 637 215 TAMILNADU, INDIA

Approved by AICTE, New Delhi, Anna University, Chennai & Accredited by NBA and NAAC with 'A' Grade

Professionals Development Cell

Certificate of Participation

This is to certify that Mr./Ms. KAVIN. M.
 of ELECTRONICS AND COMMUNICATION ENGINEERING department has participated in the
APTITUDE TRAINING
 programme held at TRAINING AND PLACEMENT CELL - KSRCE
 on 6.12.21 - 11.12.21. We wish the student all success.

Date: 11.12.21

[Signature]
Organizer

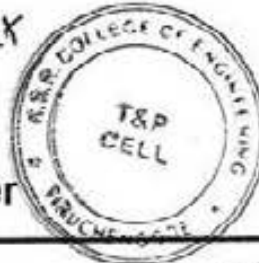

[Signature]
Co-ordinator



[Signature]
Principal
K.S.R. COLLEGE OF ENGINEERING
K.S.R. KALVI NAGAR
TIRUCHENGODE-637 215



HIGHER EDUCATIONAL CELL



2021-2022

(17)

KSRCE/QM/5.5.3/01/2021-22/TP18

K.S.R. COLLEGE OF ENGINEERING, TIRUCHENGODE - 637 215
(Autonomous)

DATE: 06-12-2021

TIME: 11.00 a.m.

CIRCULAR

ORIGINATOR: PRINCIPAL	IMMEDIATE
	CIRCULATED TO: ECE & EEE HoD

Sub.: Training Program for (2023 Batch) of ECE & EEE (Batch-3) - Reg.

Soft skill Training Program for ECE & EEE (Batch-3) 2023 Batch has been organized from 7th December 2021 to 11th December 2021 (05 Days). The morning session will be conducted from 09.30 am to 12.30 pm, the afternoon session will be from 01.30 pm to 04.00 pm and assessment will be conducted from 04.30 pm to 06.00 pm. So, all the regular classes will be cancelled for the training program. Concerned HoDs are requested to instruct their students to be in physical mode (offline mode) and attend the whole training without fail.

Instructions to the Faculty through HoDs

ECE & EEE Department T&P Co-ordinators are requested to monitor the attendance & discipline matters throughout the training program and update the HoDs concerned every day.

Instructions to the Students through Department T&P Co-ordinators & HoDs

1. Discipline
 2. Punctuality
 3. All students must wear mask and follow Standard Operating Procedure (SOP) to maintain Covid free campus.
- If any student not follows the above, he/she may not be allowed to proceed further in the process.

PRINCIPAL

Copy to:

1. ECE & EEE HODs for favor of information and circulation among current Third year students and faculty members concerned.
2. All Training & Placement Coordinators.
3. Department Notice board.

EVIDENCE OF COMPLETION

Number of persons not received / seen: _____

Signature of Originator with date and time: _____

PRINCIPAL
K.S.R. COLLEGE OF ENGINEERING
K.S.R. KALVI NAGAR,
TIRUCHENGODE-637 215



27	1915501	SABARI M	ECE	P	P	P	P	P	P	A	A	P	P
28	1915502	SREE HARISH N	ECE	P	P	P	P	P	P	P	P	A	A
29	1915503	TAMILSHRI S	ECE	P	P	P	P	P	P	P	P	P	P
TOTAL				28	29	29	29	29	29	29	29	29	29
PRESENT				27	27	27	27	28	28	27	27	24	24
ABSENT				2	2	2	2	1	1	2	2	5	5
PLACEMENT CO ORDINATOR SIGN				<i>[Signature]</i>	<i>[Signature]</i>	<i>[Signature]</i>	<i>[Signature]</i>	<i>[Signature]</i>	<i>[Signature]</i>	<i>[Signature]</i>	<i>[Signature]</i>	<i>[Signature]</i>	<i>[Signature]</i>
HOD SIGN				<i>[Signature]</i>	<i>[Signature]</i>	<i>[Signature]</i>	<i>[Signature]</i>	<i>[Signature]</i>	<i>[Signature]</i>	<i>[Signature]</i>	<i>[Signature]</i>	<i>[Signature]</i>	<i>[Signature]</i>
TRAINING OFFICER				<i>[Signature]</i>	<i>[Signature]</i>	<i>[Signature]</i>	<i>[Signature]</i>	<i>[Signature]</i>	<i>[Signature]</i>	<i>[Signature]</i>	<i>[Signature]</i>	<i>[Signature]</i>	<i>[Signature]</i>
PRINCIPAL				<i>[Signature]</i>	<i>[Signature]</i>	<i>[Signature]</i>	<i>[Signature]</i>	<i>[Signature]</i>	<i>[Signature]</i>	<i>[Signature]</i>	<i>[Signature]</i>	<i>[Signature]</i>	<i>[Signature]</i>



[Signature]
 PRINCIPAL
 K.S.R. COLLEGE OF ENGINEERING
 K.S.R. KALVI NAGAR,
 TIRUCHENGODE-637 215

K.S.R. COLLEGE OF ENGINEERING (AUTONOMOUS), TIRUCHENGODE - 637 215
TRAINING AND PLACEMENT
SOFT SKILLS (INTERNAL) TRAINING EEE ATTENDANCE DETAILS -2023 BATCH

S. No	REG NO	NAME	DATE	07.12.2021		08.12.2021		09.12.2021		10.12.2021		11.12.2021		
				FN	AN	FN	AN	FN	AN	FN	AN	FN	AN	
			BRANCH											
1	1914027	MOHAMMED SUHAIB	EEE	P	P	P	P	P	P	P	P	P	P	
2	1914028	MOHAN	EEE	P	P	P	P	A	A	A	A	P	P	
3	1914029	NALAN	EEE	P	P	P	P	P	P	P	P	P	P	
4	1914031	NAVEEN KUMAR	EEE	P	P	P	P	P	P	P	P	P	P	
5	1914034	PRASANTH	EEE	P	P	P	P	P	P	P	P	P	P	
6	1914036	RANJITHKUMAR	EEE	A	A	P	P	P	P	P	P	P	P	
7	1914039	SATHISH KUMAR	EEE	P	P	P	P	P	P	P	P	P	P	
8	1914040	SELVAKUMAR	EEE	A	A	P	P	P	P	P	P	P	P	
9	1914041	SIVAKUMAR	EEE	P	P	A	A	A	A	P	P	P	P	
10	1914042	SOMESHKANNAN	EEE	P	P	P	P	P	P	P	P	P	P	
11	1914044	SUBASH	EEE	P	P	P	P	P	P	P	P	P	P	
12	1914043	SRIDHAR	EEE	P	P	P	P	P	P	P	P	P	P	
13	1914046	SURYA PRAKASH	EEE	A	A	P	P	P	P	P	P	P	P	
14	1914047	THANUJA	EEE	P	P	P	P	P	P	P	P	P	P	
15	1914048	THULASIRAMAN	EEE	P	P	P	P	P	P	P	P	P	P	
16	1914049	VIGNESH	EEE	P	P	P	P	P	P	P	P	P	P	
17	1914050	VIJAY KUMAR	EEE	A	A	P	P	P	P	A	A	P	P	
18	1914051	YOGESHRAJ	EEE	P	P	P	P	A	A	P	P	P	P	
19	1914508	NAVANEETHAKRISHNAN	EEE	P	P	P	P	P	P	P	P	P	P	
TOTAL				19	19	19	19	19	19	19	19	19	19	19
PRESENT				15	15	18	18	16	16	17	17	19	19	
ABSENT				04	04	01	01	03	03	02	02	-	-	
PLACEMENT CO ORDINATOR SIGN				<i>[Signature]</i>	<i>[Signature]</i>	<i>[Signature]</i>	<i>[Signature]</i>	<i>[Signature]</i>	<i>[Signature]</i>	<i>[Signature]</i>	<i>[Signature]</i>	<i>[Signature]</i>	<i>[Signature]</i>	
HOD SIGN				<i>[Signature]</i>	<i>[Signature]</i>	<i>[Signature]</i>	<i>[Signature]</i>	<i>[Signature]</i>	<i>[Signature]</i>	<i>[Signature]</i>	<i>[Signature]</i>	<i>[Signature]</i>	<i>[Signature]</i>	
TRAINING OFFICER				<i>[Signature]</i>	<i>[Signature]</i>	<i>[Signature]</i>	<i>[Signature]</i>	<i>[Signature]</i>	<i>[Signature]</i>	<i>[Signature]</i>	<i>[Signature]</i>	<i>[Signature]</i>	<i>[Signature]</i>	
PRINCIPAL				<i>[Signature]</i>	<i>[Signature]</i>	<i>[Signature]</i>	<i>[Signature]</i>	<i>[Signature]</i>	<i>[Signature]</i>	<i>[Signature]</i>	<i>[Signature]</i>	<i>[Signature]</i>	<i>[Signature]</i>	

PRINCIPAL
K.S.R. COLLEGE OF ENGINEERING
K.S.R. KALVI NAGAR,
TIRUCHENGODE-637 215

KSR College of Engineering (Autonomous), Tiruchengode – 637 215

, Training and Placement Cell

Phase – 1 Soft skill Training Schedule for 2023 Batch

FN	AN
Achievers Tech Talks	Interaction
Career Planning And Campus Opportunities	Orientation
SWOT Analysis & Self Introduction	Individual Activity
Resume Building & Presentation	Individual Activity
Essay writing	Practice
Group Discussion	Group Activity
Writing Effective Emails	Individual Activity

FN Session

9.30 am to 12.30 pm

AN Session

01.30 pm to 04.00 pm

Assessment

04.30 pm to 06.00 pm

*10.46 am – 11.00am - Break

*12.30 pm – 01.30 pm -Lunch Break

* 02.46 pm – 03.00 pm – Break

PRINCIPAL
K.S.R. COLLEGE OF ENGINEERING
K.S.R. KALVI NAGAR,
TIRUCHENGODE-637 215

S. Gangaiah
1 Dec 21





K.S.R. COLLEGE OF ENGINEERING

KSRCE/QM/8.6/22/PDC

(Autonomous)

TIRUCHENGODE 637 215.TAMILNADU, INDIA.

Approved by AICTE, New Delhi, Anna University, Chennai & Accredited by NBA and NAAC with 'A' Grade

Professionals Development Cell

Certificate of Participation

This is to certify that Mr./Ms..... SUBASH.....
of ELECTRICAL AND ELECTRONICS ENGINEERING..... department has participated in the
..... SOFTSKILL TRAINING.....
programme held at TRAINING AND PLACEMENT CELL - KSRCE.....
on 7.12.21 - 11.12.21... We wish the student all success.

Date: 11.12.21

Organizer

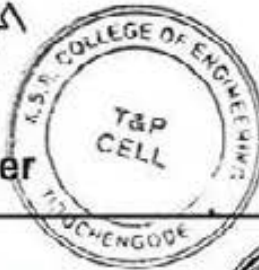

Co-ordinator

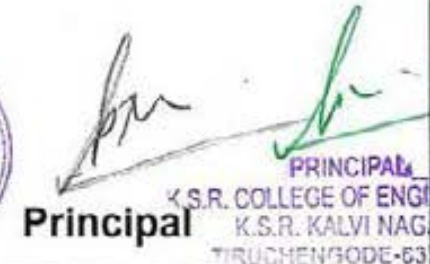

Principal
K.S.R. COLLEGE OF ENGINEERING
K.S.R. KALVI NAGAR,
TIRUCHENGODE-637 215



HIGHER EDUCATIONAL CELL





K.S.R. COLLEGE OF ENGINEERING

KSRCE/QM/8.6/22/PDC

(Autonomous)

TIRUCHENGODE 637 215.TAMILNADU, INDIA.

Approved by AICTE, New Delhi, Anna University, Chennai & Accredited by NBA and NAAC with 'A' Grade

Professionals Development Cell

Certificate of Participation

This is to certify that Mr./Ms..... SUBASH.....
of ELECTRICAL AND ELECTRONICS ENGINEERING..... department has participated in the
..... SOFTSKILL TRAINING.....
programme held at TRAINING AND PLACEMENT CELL - KSRCE.....
on 7.12.21 - 11.12.21... We wish the student all success.

Date: 11.12.21

Organizer

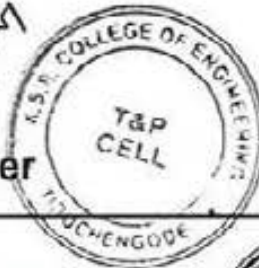

Co-ordinator

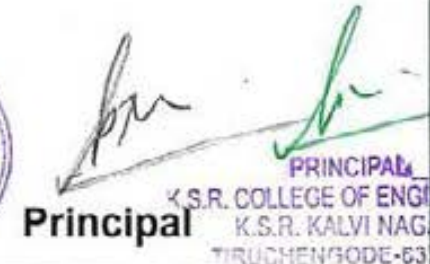

Principal
K.S.R. COLLEGE OF ENGINEERING
K.S.R. KALVI NAGAR
TIRUCHENGODE-637 215



HIGHER EDUCATIONAL CELL





KSRCE/QM/8.6/22/PDC

K.S.R. COLLEGE OF ENGINEERING

(Autonomous)

TIRUCHENGODE - 637 215 TAMILNADU, INDIA

Approved by AICTE, New Delhi, Anna University, Chennai & Accredited by NBA and NAAC with 'A' Grade

Professionals Development Cell

Certificate of Participation

This is to certify that Mr./Ms. SETHU . P.....
 of ELECTRONICS AND COMMUNICATION ENGINEERING..... department has participated in the
SOFTSKILL TRAINING
 programme held at TRAINING AND PLACEMENT CELL - KSRCE
 on 7.12.21 - 11.12.21 . We wish the student all success.

Date: 11.12.2021

S. Ganapathy
Organizer

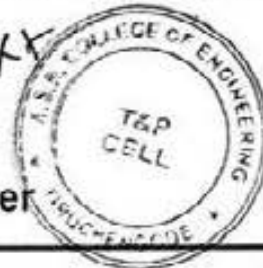

G. S. R.
Co-ordinator



[Signature]
Principal

PRINCIPAL
K.S.R. COLLEGE OF ENGINEERING
K.S.R. KALVI NAGAR,
TIRUCHENGODE - 637 211



HIGHER EDUCATIONAL CELL





KSRCE/QM/8.6/22/PDC

K.S.R. COLLEGE OF ENGINEERING

(Autonomous)

TIRUCHENGODE - 637 215.TAMILNADU, INDIA.

Approved by AICTE, New Delhi, Anna University, Chennai & Accredited by NBA and NAAC with 'A' Grade

Professionals Development Cell

Certificate of Participation

This is to certify that Mr./Ms.....RAGUL T.....

of ELECTRONICS AND COMMUNICATION ENGINEERING department has participated in the

SOFTSKILL TRAINING

programme held at TRAINING AND PLACEMENT CELL - KSRCE

on 7.12.21 - 11.12.21 . We wish the student all success.

Date: 11.12.21

S. Srinivasan
Organizer

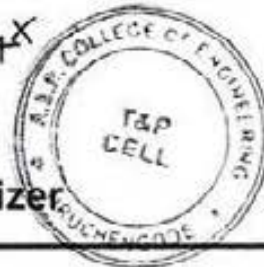

G. R. Srinivasan
Co-ordinator



K. S. R. Kalvi Naganathan
Principal

PRINCIPAL
K.S.R. COLLEGE OF ENGINEERING
K.S.R. KALVI NAGANATHAN
TIRUCHENGODE-637 215



HIGHER EDUCATIONAL CELL





K.S.R. COLLEGE OF ENGINEERING

(Autonomous)

TIRUCHENGODE - 637 215 TAMILNADU, INDIA

Approved by AICTE, New Delhi, Anna University, Chennai & Accredited by NBA and NAAC with 'A' Grade

Professionals Development Cell

Certificate of Participation

This is to certify that Mr./Ms..... VIGNESH.....
of ELECTRICAL AND ELECTRONICS ENGINEERING..... department has participated in the
..... SOFT SKILL TRAINING.....
programme held at TRAINING AND PLACEMENT CELL - KSRCE.....
on 7.12.21 - 11.12.21. We wish the student all success.

Date: 11.12.2021

[Handwritten Signature]

Organizer



[Handwritten Signature]

Co-ordinator



Principal

[Handwritten Signature]

PRINCIPAL
K.S.R. COLLEGE OF ENGINEERING
K.S.R. KALVIRANGAR
TIRUCHENGODE - 637 215



HIGHER EDUCATIONAL CELL



2021-2022

(18) (19)

KSRCE/QM/5.5.3/01/2021-22/TP

K.S.R. COLLEGE OF ENGINEERING, TIRUCHENGODE - 637 215
(Autonomous)

DATE: 11-12-2021

TIME: 03.00 p.m.

CIRCULAR

CLASSIFICATION	ROUTINE	IMMEDIATE
ORIGINATOR: PRINCIPAL		CIRCULATED TO: EEE & ECE HoDs

Sub.: Aptitude Training Program for Third Year Students (2023 Batch) of EEE & ECE (Batch 4) - Reg.

Aptitude Training Program for EEE & ECE Third Year (2023 Batch) has been organized from 13th December 2021 to 18th December 2021 (06 Days). The morning session will be conducted from 09.30 am to 12.30 pm, the afternoon session will be from 01.30 pm to 04.00 pm and assessment will be conducted from 04.30 pm to 06.00 pm. So, all the regular classes will be cancelled for the training program. Concerned HoD is requested to instruct their students to be in physical mode (offline mode) and attend the whole training without fail.

Instructions to the Faculty through HoDs

EEE & ECE Department T&P Co-ordinators are requested to monitor the attendance & discipline matters throughout the training program and update the HoDs concerned every day.

Instructions to the Students through Department T&P Co-ordinators & HoDs

1. Discipline
 2. Punctuality
 3. All students must wear mask and follow Standard Operating Procedure (SOP) to maintain Covid free campus.
- If any student not follows the above, he/she may not be allowed to proceed further in the process.



PRINCIPAL

Copy to:

1. EEE & ECE HoDs for favor of information and circulation among current Third year students and faculty members concerned.
2. All Training & Placement Coordinators.
3. Department Notice board.

EVIDENCE OF COMPLETION

Number of persons not received / seen: - _____

Signature of Originator with date and time: _____



PRINCIPAL
K.S.R. COLLEGE OF ENGINEERING
K.S.R. KALVI NAGAR,
TIRUCHENGODE-637 215

KSR College of Engineering (Autonomous), Tiruchengode – 637 215

Training and Placement Cell

Phase – 1 Aptitude Training Schedule for 2023 Batch

Date	FN	AN	
13.12.2021	Number System	Average	Assessment and Discussion
14.12.2021	Percentage	Profit and Loss	Assessment and Discussion
15.12.2021	Ratio Proportions	Problems on Ages	Assessment and Discussion
16.12.2021	Time Speed and Distance	Time and Work	Assessment and Discussion
17.12.2021	Permutation and Combination	Probability	Assessment and Discussion
18.12.2021	Blood Relation, Syllogism	Directions, Coding and Decoding	Assessment and Discussion

FN Session

9.30 am to 12.30 pm

AN Session

01.30 pm to 04.00 pm

Assessment

04.30 pm to 06.00 pm

*10.46 am – 11.00am - Break

*12.30 pm – 01.30 pm -Lunch Break

* 02.46 pm – 03.00 pm – Break

S. Gnanapath
12 Dec 21



[Signature]
PRINCIPAL
K.S.R. COLLEGE OF ENGINEERING
K.S.R. KALVI NAGAR,
TIRUCHENGODE-637 215

K.S.R. COLLEGE OF ENGINEERING (AUTONOMOUS), TIRUCHENGODE - 637 215

TRAINING AND PLACEMENT

Aptitude Training 2023 Batch (13.12.2021 To 18.12.2021)

S.No	Reg No	Name	Branch
1	1915004	ASHOKKUMAR K	ECE
2	1915006	DINESH S	ECE
3	1915007	DINESHKUMAR T	ECE
4	1915008	DIWAHAR S J	ECE
5	1915010	GOWTHAM R	ECE
6	1915011	ILAVARASAN K	ECE
7	1915013	JAGADEEP S	ECE
8	1915015	JAYAPRAKASH. M	ECE
9	1915017	KALIDAS M	ECE
10	1915018	KAMARAJ J	ECE
11	1915019	KARTHIKA DEVI. K	ECE
12	1915020	KAVIN M	ECE
13	1915021	KAVINESH K	ECE
14	1915022	KAVINMUTHU S	ECE
15	1915024	KIRANRAJ T	ECE
16	1915026	KUMAR.S	ECE
17	1915027	LINGESH S	ECE
18	1915028	LOGESH S D	ECE
19	1915029	LOKENDRAN.S	ECE
20	1915032	MANOJ T	ECE
21	1915040	PRABAKARAN R	ECE
22	1915041	PRADEEPA S	ECE
23	1915043	PRITHIVRAJ T	ECE
24	1915045	RAGUL.T	ECE
25	1915050	SANJAY R	ECE
26	1915053	SETHU B	ECE
27	1914001	ABINAYA N	EEE
28	1914007	DINESHWARAN K	EEE
29	1914008	DIVAKAR V	EEE
30	1914010	HARI GOKUL S	EEE
31	1914017	KAARTHIKEYAN S	EEE
32	1914018	KABEENA K J	EEE
33	1914021	KAVIN J R	EEE
34	1914025	KOWSIKPRABU R	EEE
35	1914026	MOHAMMED AL FAHAD	EEE
36	1914028	MOHAN R	EEE
37	1914029	NALAN R	EEE
38	1914031	NAVEEN KUMAR P	EEE
39	1914036	RANJITHKUMAR R	EEE
40	1914039	SATHISHKUMAR A	EEE
41	1914041	SIVAKUMAR S	EEE
42	1914042	SOMESHKANNAN V	EEE

 PRINCIPAL
 K.S.R. COLLEGE OF ENGINEERING
 K.S.R. KALVI NAGAR,
 TIRUCHENGODE-637 215

KSR College of Engineering (Autonomous), Tiruchengode – 637 215

Training and Placement Cell

Phase – 1 Aptitude Training Schedule for 2023 Batch

Date	FN	AN
13.12.2021	Number System	Average
14.12.2021	Percentage	Profit and Loss
15.12.2021	Ratio Proportions	Problems on Ages
16.12.2021	Time Speed and Distance	Time and Work
17.12.2021	Permutation and Combination	Probability
18.12.2021	Blood Relation, Syllogism	Directions, Coding and Decoding

FN Session

9.30 am to 12.30 pm

AN Session

01.30 pm to 04.00 pm

Assessment

04.30 pm to 06.00 pm

*10.46 am – 11.00am - Break

*12.30 pm – 01.30 pm -Lunch Break

* 02.46 pm – 03.00 pm – Break

PRINCIPAL
K.S.R. COLLEGE OF ENGINEERING
K.S.R. KALVI NAGAR,
TIRUCHENGODE-637 215





K.S.R. COLLEGE OF ENGINEERING

KSRCE/QM/8.G/22/PDC

(Autonomous)

TIRUCHENGODE - 637 215.TAMILNADU, INDIA.

Approved by AICTE, New Delhi, Anna University, Chennai & Accredited by NBA and NAAC with 'A' Grade

Professionals Development Cell

Certificate of Participation

This is to certify that Mr./Ms..... KAVIN J.R.....

of ELECTRICAL AND ELECTRONICS ENGINEERING..... department has participated in the

APTITUDE TRAINING.....

programme held at TRAINING AND PLACEMENT CELL - KSRCE.....

on 13.12.21 - 18.12.21. We wish the student all success.

Date: 18.12.21

S. Ganesh
Organizer



G. S. Aravind
Co-ordinator



[Signature]
Principal

PRINCIPAL,
K.S.R. COLLEGE OF ENGINEERING
K.S.R. KALVI NAGAR,
TIRUCHENGODE-637 215



HIGHER
EDUCATIONAL
CELL





K.S.R. COLLEGE OF ENGINEERING

KSRCE/QM/8.6/22/PDC

(Autonomous)

TIRUCHENGODE - 637 215 TAMILNADU, INDIA.

Approved by AICTE, New Delhi, Anna University, Chennai & Accredited by NBA and NAAC with 'A' Grade

Professionals Development Cell

Certificate of Participation

This is to certify that Mr./Ms. ABINAYA N.
 of ELECTRICAL AND ELECTRONICS ENGINEERING department has participated in the
APTITUDE TRAINING
 programme held at TRAINING AND PLACEMENT CELL KSRCE
 on 13.12.21 - 18.12.21. We wish the student all success.

Date: 18.12.2021



 Organizer



 Co-ordinator



 Principal

 PRINCIPAL
 K.S.R. COLLEGE OF ENGINEERING
 K.S.R. KALVI NAGAR
 TIRUCHENGODE-637 215



HIGHER EDUCATIONAL CELL





K.S.R. COLLEGE OF ENGINEERING

KSRCE/QM/8.6/22/PDC

(Autonomous)

TIRUCHENGODE - 637 215 TAMILNADU, INDIA.

Approved by AICTE, New Delhi, Anna University, Chennai & Accredited by NBA and NAAC with 'A' Grade

Professionals Development Cell

Certificate of Participation

This is to certify that Mr./Ms. LOGESHA S.D
 of ELECTRONICS AND COMMUNICATION ENGINEERING department has participated in the
APTITUDE TRAINING
 programme held at TRAINING AND PLACEMENT CELL - KSRCE
 on 13.12.21 - 18.12.21. We wish the student all success.

Date: 18.12.2021

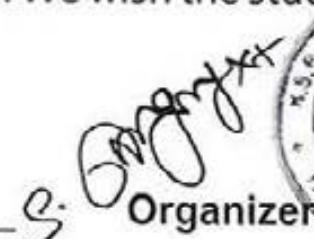
 Organizer

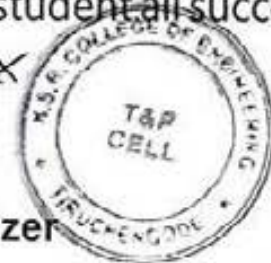

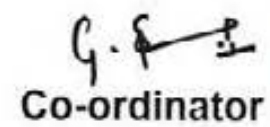
 Co-ordinator



 Principal



PRINCIPAL
 K.S.R. COLLEGE OF ENGINEERING
 K.S.R. KALVI NAGAR,
 TIRUCHENGODE-637 215



HIGHER EDUCATIONAL CELL





KSRCE/QM/8.6/22/PDC

K.S.R. COLLEGE OF ENGINEERING

(Autonomous)

TIRUCHENGODE - 637 215 TAMILNADU, INDIA.

Approved by AICTE, New Delhi, Anna University, Chennai & Accredited by NBA and NAAC with 'A' Grade

Professionals Development Cell

Certificate of Participation

This is to certify that Mr./M^s..... KUMAR S......
of ELECTRONICS AND COMMUNICATION ENGINEERING department has participated in the
..... APTITUDE TRAINING
programme held at TRAINING AND PLACEMENT CELL - KSRCE
on 13.12.21 - 18.12.21 . We wish the student all success.

Date: 18.12.2021

S. [Signature]
Organizer



G. [Signature]
Co-ordinator



[Signature]
Principal

PRINCIPAL
K.S.R. COLLEGE OF ENGINEERING
K.S.R. KALVI NAGAR
TIRUCHENGODE-637 215



HIGHER EDUCATIONAL CELL



2021-2022

19

KSRCE/QM/5.5.3/01/2021-22/TP18

K.S.R. COLLEGE OF ENGINEERING, TIRUCHENGODE – 637 215
(Autonomous)

DATE: 13-12-2021

TIME: 11.00 a.m.

CIRCULAR

ORIGINATOR: PRINCIPAL	IMMEDIATE
	CIRCULATED TO: ECE & EEE HoD

Sub.: Training Program for (2023 Batch) of ECE & EEE (Batch-3) - Reg.

Soft skill Training Program for ECE & EEE (Batch-3) 2023 Batch has been organized from 14th December 2021 to 18th December 2021 (05 Days). The morning session will be conducted from 09.30 am to 12.30 pm, the afternoon session will be from 01.30 pm to 04.00 pm and assessment will be conducted from 04.15 pm to 05.45 pm. So, all the regular classes will be cancelled for the training program. Concerned HoDs are requested to instruct their students to be in physical mode (offline mode) and attend the whole training without fail.

Instructions to the Faculty through HoDs

ECE & EEE Department T&P Co-ordinators are requested to monitor the attendance & discipline matters throughout the training program and update the HoDs concerned every day.

Instructions to the Students through Department T&P Co-ordinators & HoDs

1. Discipline
2. Punctuality
3. All students must wear mask and follow Standard Operating Procedure (SOP) to maintain Covid free campus.

If any student not follows the above, he/she may not be allowed to proceed further in the process.

S. S. Srinivasan
13 Dec 21

PRINCIPAL

Copy to:

1. ECE & EEE HODs for favor of information and circulation among current Third year students and concerned faculty members.
2. All Training & Placement Coordinators.
3. Department Notice board.

EVIDENCE OF COMPLETION

Number of persons not received / seen: _____

Signature of Originator with date and time: _____

PRINCIPAL
K.S.R. COLLEGE OF ENGINEERING
K.S.R. KALVI NAGAR,
TIRUCHENGODE-637 215

K.S.R. COLLEGE OF ENGINEERING (AUTONOMOUS), TIRUCHENGODE - 637 215

TRAINING AND PLACEMENT
Soft Skills Training 2023 Batch

S.No	Reg No	Name	Branch
1	1915004	ASHOKKUMAR K	ECE
2	1915006	DINESH S	ECE
3	1915007	DINESHKUMAR T	ECE
4	1915008	DIWAHAR S J	ECE
5	1915010	GOWTHAM R	ECE
6	1915011	ILAVARASAN K	ECE
7	1915013	JAGADEEP S	ECE
8	1915015	JAYAPRAKASH. M	ECE
9	1915017	KALIDAS M	ECE
10	1915018	KAMARAJ J	ECE
11	1915019	KARTHIKA DEVI. K	ECE
12	1915020	KAVIN M	ECE
13	1915021	KAVINESH K	ECE
14	1915022	KAVINMUTHU S	ECE
15	1915024	KIRANRAJ T	ECE
16	1915026	KUMAR.S	ECE
17	1915027	LINGESH S	ECE
18	1915028	LOGESH S D	ECE
19	1915029	LOKENDRAN.S	ECE
20	1915032	MANOJ T	ECE
21	1915040	PRABAKARAN R	ECE
22	1915041	PRADEEPA S	ECE
23	1915043	PRITHIVRAJ T	ECE
24	1915045	RAGUL T	ECE
25	1915050	SANJAY R	ECE
26	1914001	ABINAYA N	EEE
27	1914007	DINESHWARAN K	EEE
28	1914008	DIVAKAR V	EEE
29	1914010	HARI GOKUL S	EEE
30	1914017	KAARTHIKEYAN S	EEE
31	1914018	KABEENA K J	EEE
32	1914021	KAVIN J R	EEE
33	1914025	KOWSIKPRABU R	EEE
34	1914026	MOHAMMED AL FAHAD	EEE
35	1914028	MOHAN R	EEE
36	1914029	NALAN R	EEE
37	1914031	NAVEEN KUMAR P	EEE
38	1914036	RANJITHKUMAR R	EEE
39	1914039	SATHISHKUMAR A	EEE
40	1914041	SIVAKUMAR S	EEE
41	1914042	SOMESHKANNAN V	EEE
42	1914043	SRIDHAR A	EEE

PRINCIPAL
K.S.R. COLLEGE OF ENGINEERING
K.S.R. KALVI NAGAR,
TIRUCHENGODE-637 215

43	1914046	SURYAPRAKASH S	EEE
44	1914047	THANUJA G V	EEE
45	1914049	VIGNESH E	EEE

S. Anand
14 Dec 21



PRINCIPAL
K.S.R. COLLEGE OF ENGINEERING
K.S.R. KALVI NAGAR,
TIRUCHENGODE-637 215.

KSR College of Engineering (Autonomous), Tiruchengode – 637 215

Training and Placement Cell

Phase – 1 Soft skill Training Schedule for 2023 Batch

FN	AN
Achievers Tech Talks	Interaction
Career Planning And Campus Opportunities	Orientation
SWOT Analysis & Self Introduction	Individual Activity
Resume Building & Presentation	Individual Activity
Essay writing	Practice
Group Discussion	Group Activity
Writing Effective Emails	Individual Activity

FN Session

9.30 am to 12.30 pm

AN Session

01.30 pm to 04.00 pm

Assessment

04.30 pm to 06.00 pm

*10.46 am – 11.00am - Break

*12.30 pm – 01.30 pm -Lunch Break

* 02.46 pm – 03.00 pm – Break

PRINCIPAL
K.S.R. COLLEGE OF ENGINEERING
K.S.R. KALVI NAGAR,
TIRUCHENGODE-637 215

S. Gangajayam
14 Dec 21





KSRCE/QM/8.6/22/PDC

K.S.R. COLLEGE OF ENGINEERING

(Autonomous)

TIRUCHENGODE - 637 215, TAMILNADU, INDIA.

Approved by AICTE, New Delhi, Anna University, Chennai & Accredited by NBA and NAAC with 'A' Grade

Professionals Development Cell

Certificate of Participation

This is to certify that ~~Mr./Ms.~~..... THANUJA G.V......
of ELECTRICAL AND ELECTRONICS ENGINEERING department has participated in the
SOFT SKILL TRAINING
programme held at TRAINING AND PLACEMENT CELL - KSRCE
on 14.12.21 - 18.12.21. We wish the student all success.

Date: 18.12.21

Organizer



Co-ordinator



Principal
K.S.R. COLLEGE OF ENGINEERING
K.S.R. KALVI NAGAR,
TIRUCHENGODE-637 215



HIGHER EDUCATIONAL CELL





K.S.R. COLLEGE OF ENGINEERING

KSRCE/QM/8.6/22/PDC

(Autonomous)

TIRUCHENGODE - 637 215. TAMILNADU, INDIA.

Approved by AICTE, New Delhi, Anna University, Chennai & Accredited by NBA and NAAC with 'A' Grade

Professionals Development Cell

Certificate of Participation

This is to certify that Mr./Ms. DIVAGAR V.....
 of ELECTRICAL AND ELECTRONICS ENGINEERING..... department has participated in the
SOFT SKILL TRAINING.....
 programme held at TRAINING AND PLACEMENT CELL - KSRCE.....
 on 14.12.21 - 18.12.21..... We wish the student all success.

Date: 18.12.21

[Signature]
 Organizer



[Signature]
 Co-ordinator



[Signature]
 Principal
 K.S.R. COLLEGE OF ENGINEERING
 K.S.R. KALVI NAGAR,
 TIRUCHENGODE, 637 215



HIGHER EDUCATIONAL CELL





KSRCE/QM/8.6/22/PDC

K.S.R. COLLEGE OF ENGINEERING

(Autonomous)

TIRUCHENGODE - 637 215. TAMILNADU, INDIA.

Approved by AICTE, New Delhi, Anna University, Chennai & Accredited by NBA and NAAC with 'A' Grade

Professionals Development Cell

Certificate of Participation

This is to certify that Mr./Ms..... LINGESH S.....
of ELECTRONICS AND COMMUNICATION ENGINEERING department has participated in the
..... SOFT SKILL TRAINING
programme held at TRAINING AND PLACEMENT CELL - KSRCE
on 14.12.21 - 18.12.21 . We wish the student all success.

Date: 18.12.21

S. Manjath
Organizer



G. S.
Co-ordinator



[Signature]
Principal

[Signature]
PRINCIPAL

K.S.R. COLLEGE OF ENGINEERING
K.S.R. KALVI NAGAR
TIRUCHENGODE-637 215



HIGHER EDUCATIONAL CELL





KSRCE/QM/8.6/22/PDC

K.S.R. COLLEGE OF ENGINEERING

(Autonomous)

TIRUCHENGODE - 637 215 TAMIL NADU, INDIA.

Approved by AICTE, New Delhi, Anna University, Chennai & Accredited by NBA and NAAC with 'A' Grade

Professionals Development Cell

Certificate of Participation

This is to certify that Mr./Ms..... JEGATHEEP S.....
 of ELECTRONICS AND COMMUNICATION ENGINEERING department has participated in the
SOFT SKILL TRAINING
 programme held at TRAINING AND PLACEMENT CELL - KSRCE
 on 14.12.21 - 18.12.21. We wish the student all success.

Date: 18.12.21

S. Jagan
Organizer

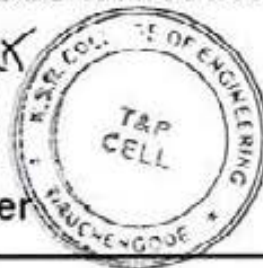

G. S. S.
Co-ordinator



K. S. Kalvinagar
Principal
K.S.R. COLLEGE OF ENGINEERING
K.S.R. KALVINAGAR,
TIRUCHENGODE-637 215



HIGHER EDUCATIONAL CELL



2021-2022 (21)

KSRCE/QM/S.5.3/01/2021-22/TP39

K.S.R. COLLEGE OF ENGINEERING, TIRUCHENGODE - 637 215
(Autonomous)

DATE: 12-01-2021

TIME: 03.00 p.m.

CIRCULAR

CLASSIFICATION	ROUTINE	IMMEDIATE
ORIGINATOR: PRINCIPAL		CIRCULATED TO: ALL HoDs

Sub.: Aptitude & Soft Skills Training Program for Second and Third Year Students (2023 Batch) - Reg.

Aptitude Training Program for AUTO, CIVIL and MECHANICAL department Third Year (2023 Batch) students and Soft Skill Training Program for IT department Second Year (2024 Batch) students has been organized from 19th January 2022 to 26th January 2022 (06 Days). The session will be conducted from 09.30 am to 12.30 pm and the assessment will be conducted in the afternoon. So, all the regular classes will be cancelled for the training program. Concerned HoDs are requested to instruct their students to be in online mode and attend the whole training without fail.

Instructions to the Faculty through HoDs

AUTO, CIVIL, IT and MECHANICAL Department T&P Co-ordinators are requested to monitor the attendance & discipline matters throughout the training program and update the concerned HoD every day.

Instructions to the Students through Department T&P Co-ordinators & HoDs

1. Discipline
2. Punctuality

PRINCIPAL

Copy to:

1. ALL HoDs for favor of information and circulation among students and faculty members concerned.
2. All Training & Placement Coordinators.
3. Department Notice board.

EVIDENCE OF COMPLETION

Number of persons not received / seen: _____

Signature of Originator with date and time: _____





PRINCIPAL
K.S.R. COLLEGE OF ENGINEERING
K.S.R. KALVI NAGAR,
TIRUCHENGODE-637 215

K.S.R. COLLEGE OF ENGINEERING (AUTONOMOUS), TIRUCHENGODE - 637 215
TRAINING AND PLACEMENT

Aptitude Training 2022 for 2023 Batch (19.01.2022 To 25.01.2022)

S.No	Reg No	Name	Branch
1	1911001	Balachandar. A	AUTO
2	1911003	Deepaprasanth. M	AUTO
3	1911004	Dharani.M	AUTO
4	1911005	Dharunraj.P	AUTO
5	1911006	Gokul Pranesh.C	AUTO
6	1911007	Hari prasath.J	AUTO
7	1911008	Hari Ganesh.H	AUTO
8	1911011	Kaviprasanth.P	AUTO
9	1911012	Naveen kumar R D	AUTO
10	1911013	Nitheesh.B	AUTO
11	1911015	Nithyashree R	AUTO
12	1911016	Praveen .M	AUTO
13	1911017	Ragul .S	AUTO
14	1911019	Sathish.S	AUTO
15	1911020	Sridhar.V.R	AUTO
16	1911021	Subasakthivel M	AUTO
17	1911023	Sugumar D	AUTO
18	1911024	Sujeeth V	AUTO
19	1911025	Vasanthakumar K.S	AUTO
20	1911026	Vijay.P	AUTO
21	1911501	Arunkumaran.R	AUTO
22	1911502	Bharath P	AUTO
23	1911503	Dhanish.V	AUTO
24	1911505	Gowshik A	AUTO
25	1911507	Mohanraj B	AUTO
26	1911508	Mohanraj S	AUTO
27	1911509	Murali R	AUTO
28	1911510	Naveen M	AUTO
29	1911511	Prabhu. S	AUTO
30	1911512	Praveen M	AUTO
31	1911513	Raaj Kumar M	AUTO
32	1911514	Ragunath G	AUTO
33	1911515	Raja.V	AUTO
34	1911516	Santhoshkumar A	AUTO
35	1911517	Santhoshkumar K.M	AUTO
36	1911518	Sathiyananthan. KKK	AUTO
37	1916001	Aravinth karthi s	MECH
38	1916002	ARJUN AJAYAGOSH	MECH
39	1916003	ASTILE ROSHAN N	MECH
40	1916004	BARATH N S	MECH
41	1916005	CHANDRU.A	MECH
42	1916007	CHENNAKESAVAN V	MECH



PRINCIPAL
K.S.R. COLLEGE OF ENGINEERING
K.S.R. KALVI NAGAR,
TIRUCHENGODE-637 215

43	1916008	DAYANAND G V	MECH
44	1916009	R Dhayanithi	MECH
45	1916010	DINESH P	MECH
46	1916011	DINESHKUMAR M	MECH
47	1916012	ELAVARASAN.A	MECH
48	1916013	GNANASELVARAJ P	MECH
49	1916014	GOKUL	MECH
50	1916016	Gopalakrishnan.T	MECH
51	1916018	GUHAN P	MECH
52	1916019	GURUNASAMY G	MECH
53	1916020	KAMESH.S	MECH
54	1916021	Kavi. M	MECH
55	1916025	B.KAVINRAJ	MECH
56	1916026	V KAVIYARASAN	MECH
57	1916027	KIRAN VARGHESE	MECH
58	1916028	KISHORE J	MECH
59	1916029	S. Kowshikan	MECH
60	1916031	MAHENDRA KUMAR R	MECH
61	1916032	MAHESHKUMAR M	MECH
62	1916033	MATHANKANNAN M	MECH
63	1916034	MATHESH M	MECH
64	1916036	E PRAHATHEESWAR	MECH
65	1916037	Praveen. R	MECH
66	1916038	Priyadharsan	MECH
67	1916039	PUVI ARASU S	MECH
68	1916040	S. RITHICK	MECH
69	1916041	V.K.SABARIKIRIRAJ	MECH
70	1916042	Santhosh Govindharaju	MECH
71	1916043	SATHISH C	MECH
72	1916044	Senthilvelan B	MECH
73	1916048	SRINIVASAN.R	MECH
74	1916049	Subash prabhu.M	MECH
75	1916050	SUDHARSAN C	MECH
76	1916051	SUNDARESAN S	MECH
77	1916052	S. Thinakaran	MECH
78	1916053	VELMURUGAN.A	MECH
79	1916501	AJAYPRASANTH M	MECH
80	1916502	M.Arunkumar	MECH
81	1916503	DEEPANKUMAR K	MECH
82	1916504	Dhanushraja T	MECH
83	1916505	DHARUNPRASATH.V	MECH
84	1916506	DHUVARAGA PRASATH.S	MECH
85	1916509	GOKUL.R	MECH
86	1916509	GOKUL.R	MECH
87	1916510	GOKULRAJ A	MECH
88	1916511	JAGADESH. J	MECH
89	1916512	KALAIYARASAN T	MECH

 PRINCIPAL
 K.S.R. COLLEGE OF ENGINEERING
 K.S.R. KALVI NAGAR,
 TIRUCHENGODE-637 215

90	1916513	Kishor G	MECH
91	1916514	LOGESHWARAN M	MECH
92	1916515	C.MAKESKUMAR	MECH
93	1916517	MOHANRAJA R	MECH
94	1916518	NANDHA KUMAR S	MECH
95	1916519	E.J.NANDHA KUMAR	MECH
96	1916520	Nandhakumar.S	MECH
97	1916521	NAVEENKUMAR P	MECH
98	1916523	B.RANJITH KUMAR	MECH
99	1916524	g.rohit	MECH
100	1916525	SAKTHIVEL.K	MECH
101	1916526	SAKTHIVELAN N	MECH
102	1916528	SANJAY V	MECH
103	1916529	M. SANTHOSH	MECH
104	1916531	SATHEESHKUMAR	MECH
105	1916532	R. TAMILINIYAN	MECH
106	1916533	K.Vasanthakumar	MECH
107	1916536	YOGESH AYANAR.S	MECH
108	1916013	GNANASELVARAJ P	MECH
109	1916014	GOKUL C	MECH
110	1916020	KAMESH S	MECH
111	1916021	KAVI M	MECH
112	1916053	VELMURUGAN.A	MECH
113	1916502	ARUNKUMAR M	MECH
114	1916505	DHARUNPRASATH.V	MECH
115	1916507	MOHAMED FAIZUL	MECH
116	1916513	KISHORE G	MECH
117	1916514	LOGESHWARAN M	MECH
118	1916515	MAKESKUMAR C	MECH
119	1916516	MANOJ G	MECH
120	1916517	MOHANRAJA R	MECH
121	1916520	NANDHAKUMAR S	MECH
122	1916521	NAVEENKUMAR P	MECH
123	1912001	ARULKUMARAN S	CIVIL
124	1912002	K.DHILEEPAN	CIVIL
125	1912003	Gowtham. M	CIVIL
126	1912004	Karunakaran	CIVIL
127	1912005	Kavinraj. T	CIVIL
128	1912006	Madhankumar. P	CIVIL
129	1912007	T.MANICKAVEL	CIVIL
130	1912008	K.MONISH	CIVIL
131	1912009	R.Nallenthiran	CIVIL
132	1912011	S.Prabhakaran	CIVIL
133	1912012	Sanjay Kumaran D	CIVIL
134	1912013	M.SARAVANAN	CIVIL
135	1912014	Sathishkumar.m	CIVIL
136	1912015	SETHURAMAN M	CIVIL

 PRINCIPAL
 K.S.R. COLLEGE OF ENGINEERING
 K.S.R. KALVI NAGAR,
 TIRUCHENGODE-637 215

137	1912018	S.Venu Aravind	CIVIL
138	1912501	V.Naveen	CIVIL
139	1912503	N.R.Rahul	CIVIL
140	1912504	Ranjith Kumar p	CIVIL
141	1912016	SOHAIL MAQBOOL BHAT	CIVIL
142	1912005	KAVINRAJ T	CIVIL
143	1912014	SATHISHKUMAR M	CIVIL

S. Gnanapriya
19 Jun 22



PRINCIPAL
K.S.R. COLLEGE OF ENGINEERING
K.S.R. KALVI NAGAR,
TIRUCHENGODE-637 215



K.S.R. COLLEGE OF ENGINEERING

(Autonomous)

TIRUCHENGODE - 637 215. TAMILNADU, INDIA.

Approved by AICTE, New Delhi, Anna University, Chennai & Accredited by NBA and NAAC with 'A' Grade

Professionals Development Cell

Certificate of Participation

This is to certify that Mr./Ms..... NAVEEN..... V......

of CIVIL ENGINEERING..... department has participated in the

..... APTITUDE TRAINING PROGRAMME.....

programme held at TRAINING AND PLACEMENT CELL - KSRCE.....

on 19.01.22 - 26.01.22. We wish the student all success.

Date: 26.01.22  Organizer

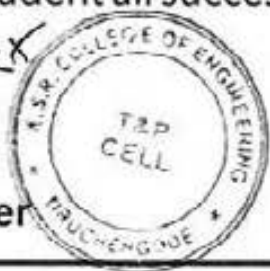

 Co-ordinator



 Principal
K.S.R. COLLEGE OF ENGINEERING
K.S.R., KALVI NAGAR
TIRUCHENGODE-637 215



HIGHER EDUCATIONAL CELL





KSRCE/QM/8.6/22/PDC

K.S.R. COLLEGE OF ENGINEERING

(Autonomous)

TIRUCHENGODE - 637 215. TAMILNADU, INDIA.

Approved by AICTE, New Delhi, Anna University, Chennai & Accredited by NBA and NAAC with 'A' Grade

Professionals Development Cell

Certificate of Participation

This is to certify that Mr./Ms..... ELAVARASAN.....A.....
 of MECHANICAL.....ENGINEERING.....department has participated in the
APTITUDE TRAINING PROGRAMME.....
 programme held at TRAINING AND PLACEMENT CELL - KSRCE.....
 on 19.01.22 - 26.01.22. We wish the student all success.

Date: 26.01.2022

S. Ganapathy
Organizer



G. S. S.
Co-ordinator



[Signature]
Principal

PRINCIPAL
K.S.R. COLLEGE OF ENGINEERING
K.S.R. KALVI NAGAR
TIRUCHENGODE - 637 215



HIGHER EDUCATIONAL CELL





KSRCE/QM/8.6/22/PDC

K.S.R. COLLEGE OF ENGINEERING

(Autonomous)

TIRUCHENGODE - 637 215. TAMILNADU, INDIA.

Approved by AICTE, New Delhi, Anna University, Chennai & Accredited by NBA and NAAC with 'A' Grade

Professionals Development Cell

Certificate of Participation

This is to certify that Mr./Ms. PRABHU S

of AUTOMOBILE ENGINEERING department has participated in the

APTITUDE TRAINING PROGRAMME

programme held at TRAINING AND PLACEMENT CELL - KSRCE

on 19.01.22 - 26.01.22. We wish the student all success.

Date: 26.01.22

[Signature]
Organizer



[Signature]
Co-ordinator



[Signature]
Principal
K.S.R. COLLEGE OF ENGINEERING
K.S.R. KALVI NAGAR,
TIRUCHENGODE, 637 215



HIGHER EDUCATIONAL CELL





KSRCE/QM/8.6/22/PDC

K.S.R. COLLEGE OF ENGINEERING

(Autonomous)

TIRUCHENGODE - 637 215 TAMIL NADU, INDIA.

Approved by AICTE, New Delhi, Anna University, Chennai & Accredited by NBA and NAAC with 'A' Grade

Professionals Development Cell

Certificate of Participation

This is to certify that Mr./Ms. DHARANI M.
 of AUTOMOBILE ENGINEERING department has participated in the
APTITUDE TRAINING PROGRAMME
 programme held at TRAINING AND PLACEMENT CELL - KSRCE
 on 19.01.22 - 26.01.22. We wish the student all success.

Date: 26.01.22

 Organizer

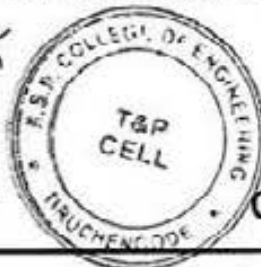

 Co-ordinator



 Principal
 K.S.R. COLLEGE OF ENGINEERING
 K.S.R. KALVI NAGAR,
 TIRUCHENGODE-637 215



HIGHER EDUCATIONAL CELL



K.S.R. COLLEGE OF ENGINEERING, TIRUCHENGODE – 637 215
(Autonomous)

DATE: 18-01-2022

TIME: 12.00 p.m.

CIRCULAR

CLASSIFICATION	ROUTINE	IMMEDIATE
ORIGINATOR: PRINCIPAL		CIRCULATED TO: IT HoD

Sub.: Training Program for Second Year Students (2024 Batch) of IT - Reg.

Soft Skills Training Program for IT second Year (2024 Batch) has been organized from 19th January 2022 to 25th January 2021 (06 Days). The morning session will be conducted from 09.30 am to 12.30 pm, the afternoon session will be from 01.30 pm to 04.00 pm and assessment will be conducted from 04.30 pm to 06.00 pm. So, all the regular classes will be cancelled for the training program. Concerned HoD is requested to instruct their students to be in physical mode (offline mode) and attend the whole training without fail.

Instructions to the Faculty through HoDs

CSE Department T&P Co-ordinator is requested to monitor the attendance & discipline matters throughout the training program and update the HoDs concerned every day.

Instructions to the Students through Department T&P Co-ordinators & HoD

1. Discipline
2. Punctuality
3. All students must wear mask and follow Standard Operating Procedure (SOP) to maintain Covid free campus. If any student not follows the above, he/she may not be allowed to proceed further in the process.



PRINCIPAL

Copy to:

1. IT HOD for favor of information and circulation among current Third year students and faculty members concerned.
2. All Training & Placement Coordinators.
3. Department Notice board.

EVIDENCE OF COMPLETION

Number of persons not received / seen: - _____

Signature of Originator with date and time: _____



PRINCIPAL

K.S.R. COLLEGE OF ENGINEERING
K.S.R. KALVI NAGAR,
TIRUCHENGODE-637 215

K.S.R. COLLEGE OF ENGINEERING (AUTONOMOUS), TIRUCHENGODE - 637 215

TRAINING AND PLACEMENT

IT SOFTSKILLS TRAINING NAME LIST -2024 BATCH

S. No	REG NO	NAME	BRANCH
1	2021001	ABISHEK.U	IT
2	2021002	ABISHEK.R.S	IT
3	2021003	BALAJI.M	IT
4	2021004	BATSHA. T	IT
5	2021005	BHARATHI.P	IT
6	2021006	BHASKARAPRASATH.S.K	IT
7	2021007	BHUVANESH.G	IT
8	2021008	DHANUSHYA.K	IT
9	2021009	DIVYA.K	IT
10	2021011	FARITHA BANU.M	IT
11	2021012	GIRIJA.V	IT
12	2021014	GOBIKA.C	IT
13	2021015	GOKUL.R	IT
14	2021017	GOPI.M	IT
15	2021018	GOPINATH.N	IT
16	2021019	HARI PRASATH.S	IT
17	2021020	HARI PRIYA.G	IT
18	2021021	KALPANA.V	IT
19	2021022	KANISHKA.V	IT
20	2021023	KAVIN.S	IT
21	2021024	KAVIN KUMAR.R	IT
22	2021025	KISHORE.B	IT
23	2021026	LALITH KUMAR.R	IT
24	2021027	LOGA MOORTHY.S	IT
25	2021028	MANIBHARATHI.J	IT
26	2021029	MANIKANDAN.S	IT
27	2021030	MITHRA.S.P	IT
28	2021031	MOHAMEDFAHEEM.S	IT
29	2021032	MOHAN.G	IT
30	2021034	PAVITHRA.S	IT
31	2021035	POOVARASAN.G	IT
32	2021036	POOVARASAN.G	IT
33	2021037	PRASANTH.N	IT
34	2021038	PRAVEENKUMAR.V	IT
35	2021039	PRAVINKUMAR.M	IT
36	2021040	PRIYANKA.P	IT
37	2021041	RAVISANKAR.G	IT
38	2021042	RITTHISH.R.V	IT
39	2021043	SANJAY.J	IT
40	2021044	SANTHOSH.A	IT
41	2021045	SATHISH.A	IT
42	2021047	SHARVESH.M	IT
43	2021048	SHEVAKSRI.P	IT

PRINCIPAL

K.S.R. COLLEGE OF ENGINEERING
K.S.R. KALVI NAGAR,
TIRUCHENGODE-637 215

44	2021049	SRITHAR.S.V	IT
45	2021050	SUGANESH.G	IT
46	2021051	SURRIYAA.P.P	IT
47	2021052	SUWETHAA.M.K	IT
48	2021053	TAMILZHARASU.M.P	IT
49	2021054	VASANTH.P	IT
50	2021055	VASANTH.V	IT
51	2021056	VASUDEVAN.R	IT
52	2021057	VIGNESH.S	IT
53	2021058	VIGNESH.C	IT
54	2021059	VIMALAA SRI.V.S	IT
55	2021060	YUVASREE.S	IT
56	20LIT001	ESWAR CHANDAR. P	IT
57	20LIT002	GOWTHAMAN .S	IT
58	20LIT004	PRAKASH .K	IT
59	20LIT005	SIVABALAN. G	IT
60	20LIT006	VIDHYASRI. G	IT



PRINCIPAL
K.S.R. COLLEGE OF ENGINEERING
K.S.R. KALVI NAGAR,
TIRUCHENGODE-637 215

KSR College of Engineering (Autonomous), Tiruchengode – 637 215

Training and Placement Cell

Phase – 1 Soft skill Training Schedule for 2023 Batch

FN	AN
Achievers Tech Talks	Interaction
Career Planning And Campus Opportunities	Orientation
SWOT Analysis & Self Introduction	Individual Activity
Resume Building & Presentation	Individual Activity
Essay writing	Practice
Group Discussion	Group Activity
Writing Effective Emails	Individual Activity

FN Session

9.30 am to 12.30 pm

AN Session

01.30 pm to 04.00 pm

Assessment

04.30 pm to 06.00 pm

*10.46 am – 11.00am - Break

*12.30 pm – 01.30 pm -Lunch Break

* 02.46 pm – 03.00 pm – Break

*S. Garganath
19 June 22*



[Signature]
PRINCIPAL
K.S.R. COLLEGE OF ENGINEERING
K.S.R. KALVI NAGAR,
TIRUCHENGODE-637 215



KSRCE/QM/8.6/22/PDC

K.S.R. COLLEGE OF ENGINEERING

(Autonomous)

TIRUCHENGODE - 637 215. TAMILNADU, INDIA.

Approved by AICTE, New Delhi, Anna University, Chennai & Accredited by NBA and NAAC with 'A' Grade

Professionals Development Cell

Certificate of Participation

This is to certify that Mr./Ms..... STYABALAN. G......

of..... INFORMATION TECHNOLOGY..... department has participated in the

..... SOFT SKILL TRAINING.....

programme held at..... TRAINING AND PLACEMENT CELL - KSRCE.....

on 19.1.22 - 25.01.22. We wish the student all success.

Date: 25.01.22.

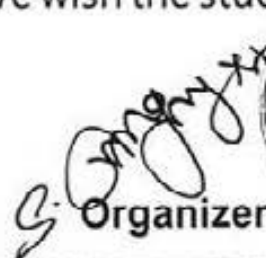
Organizer

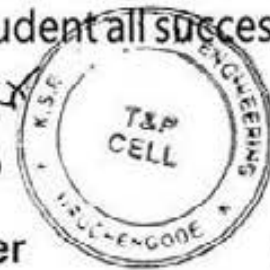

Co-ordinator



Principal

PRINCIPAL
K.S.R. COLLEGE OF ENGINEERING
K.S.R. KALYANAGAR
TIRUCHENGODE-637 215



HIGHER EDUCATIONAL CELL





K.S.R. COLLEGE OF ENGINEERING

KSRCE/QM/0.6/22/PDC

(Autonomous)

TIRUCHENGODE - 637 215.TAMILNADU, INDIA.

Approved by AICTE, New Delhi, Anna University, Chennai & Accredited by NBA and NAAC with 'A' Grade

Professionals Development Cell

Certificate of Participation

This is to certify that Mr./Ms..... SATHISH .A.....
of INFORMATION TECHNOLOGY..... department has participated in the
SOFT SKILL TRAINING.....
programme held at TRAINING AND PLACEMENT CELL - KSRCE.....
on 19.01.22 - 25.01.22. We wish the student all success.

Date: 25.01.2022

Organizer

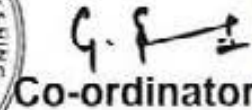

Co-ordinator



Principal
K.S.R. COLLEGE OF ENGINEERING
K.S.R. KALVI NAGAR
TIRUCHENGODE-637 215



HIGHER EDUCATIONAL CELL





KSRCE/QM/8.G/22/PDC

K.S.R. COLLEGE OF ENGINEERING

(Autonomous)



TIRUCHENGODE - 637 215. TAMILNADU, INDIA.

Approved by AICTE, New Delhi, Anna University, Chennai & Accredited by NBA and NAAC with 'A' Grade

Professionals Development Cell

Certificate of Participation

This is to certify that Mr./Ms..... MOHAN, G.....
 of..... INFORMATION TECHNOLOGY..... department has participated in the
 SOFT SKILL TRAINING.....
 programme held at TRAINING AND PLACEMENT CELL - KSRCE.....
 on 19.01.22 - 25.01.22. We wish the student all success.

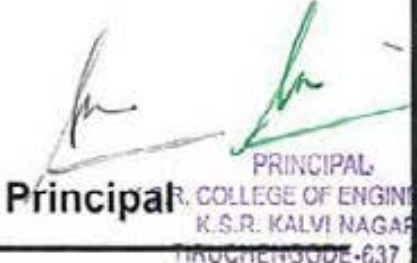
Date: 25.01.2022 *S. Ganapathy* Organizer 
G. S. S. Co-ordinator 
[Signature] Principal  PRINCIPAL
 K.S.R. COLLEGE OF ENGINEERING
 K.S.R. KALVI NAGAR
 TIRUCHENGODE-637 215



HIGHER EDUCATIONAL CELL





KSRCE/QM/8.6/22/PDC

K.S.R. COLLEGE OF ENGINEERING

(Autonomous)

TIRUCHENGODE - 637 215 TAMILNADU, INDIA

Approved by AICTE, New Delhi, Anna University, Chennai & Accredited by NBA and NAAC with 'A' Grade

Professionals Development Cell

Certificate of Participation

This is to certify that Mr./Ms. GOPT. M
 of INFORMATION TECHNOLOGY department has participated in the
SOFT SKILL TRAINING
 programme held at TRAINING AND PLACEMENT CELL - KSRCE
 on 19.01.22 - 25.01.22. We wish the student all success.

Date: 25.01.2022

[Signature]
 Organizer

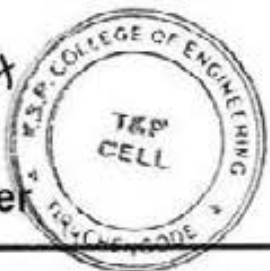

[Signature]
 Co-ordinator



[Signature]
 Principal

PRINCIPAL
 K.S.R. COLLEGE OF ENGINEERING
 K.S.R. KALVI NAGAR,
 TIRUCHENGODE-637 215



HIGHER EDUCATIONAL CELL



2021-2022

(23)

KSRCE/QM/5.5.3/01/2021-22/TP40

K.S.R. COLLEGE OF ENGINEERING, TIRUCHENGODE – 637 215
(Autonomous)

DATE: 18-02-2022

TIME: 01.00 PM.

CIRCULAR

CLASSIFICATION	ROUTINE	IMMEDIATE
ORIGINATOR: PRINCIPAL		CIRCULATED TO: All HoDs

Sub.: Training Program for Pre Final Year Students of B.E/B.Tech (2023 Batch) - Reg.

Training Program for all Pre Final Year placement willing Students (2023 Batch) has been organized from 23rd February 2022 onwards. The morning session will be conducted from 09.30 am to 12.30 pm, the afternoon session will be from 01.30 pm to 04.00 pm. So, all the regular classes will be canceled for the training students. Concerned HoDs are requested to instruct their students to be present in physical mode on time and attend the whole training without fail.

Instructions to the Faculty through HoDs

1. All Department Placement Co-ordinators are requested to monitor the attendance & discipline matters throughout the training program and update the progress to HoDs concerned every day.

Instructions to the Students through Department T&P Co-ordinators & HoDs

1. Discipline
2. Punctuality

If any student not follows the above he/she may not be allowed to proceed further in the process.

PRINCIPAL

Copy to:

1. All HoDs for favor of information and circulation among current Final year students and faculty members concerned.
2. All Training & Placement Coordinators.
3. Department Notice board.

EVIDENCE OF COMPLETION

Number of persons not received / seen: - _____

Signature of Originator with date and time: _____



PRINCIPAL
K.S.R. COLLEGE OF ENGINEERING
K.S.R. KALVI NAGAR,
TIRUCHENGODE-637 215

K.S.R. COLLEGE OF ENGINEERING (AUTONOMOUS), TIRUCHENGODE - 637 215

TRAINING AND PLACEMENT

TECHNICAL (INTERNAL) TRAINING AUTO ATTENDANCE DETAILS -2023 BATCH

S. No	REG NO	NAME	DATE	BATCH	23.02.2022		24.02.2022		25.02.2022		26.02.2022		28.2.22		01.3.22		02.3.22	
					FN	AN	FN	AN	FN	AN	FN	AN	FN	AN	FN	AN	FN	AN
					BRANCH													
1	1911001	BALACHANDAR A	AUTO	BATCH 3	/	/	/	/	/	/	/	/	/	/	/	/	/	/
2	1911006	GOKULPRANESH C	AUTO	BATCH 3	/	/	/	/	/	/	/	/	/	/	/	/	/	/
3	1911008	HARIGANESH V	AUTO	BATCH 3	/	/	/	/	/	/	/	/	/	/	/	/	/	/
4	1911015	NITHYASHREE R	AUTO	BATCH 3	/	/	/	/	/	/	/	/	/	/	/	/	/	/
5	1911023	SUGUMAR D	AUTO	BATCH 3	/	/	/	/	/	/	/	/	/	/	/	/	/	/
6	1911024	SUJEETH N	AUTO	BATCH 3	/	/	/	/	/	/	/	/	/	/	/	/	/	/
7	1911026	VIJAY P	AUTO	BATCH 3	/	/	/	/	/	/	/	/	/	/	/	/	/	/
TOTAL					7	7	7	7	7	7	7	7	7	7	7	7	7	7
PRESENT					7	7	7	7	7	7	7	7	7	7	7	7	7	7
ABSENT					-	-	-	-	-	-	-	-	-	-	-	-	-	-
PLACEMENT CO ORDINATOR SIGN					<i>[Signature]</i>	<i>[Signature]</i>	<i>[Signature]</i>	<i>[Signature]</i>	<i>[Signature]</i>	<i>[Signature]</i>	<i>[Signature]</i>	<i>[Signature]</i>	<i>[Signature]</i>	<i>[Signature]</i>	<i>[Signature]</i>	<i>[Signature]</i>	<i>[Signature]</i>	<i>[Signature]</i>
HOD SIGN					R. H. H	R. H. H	R. H. H	R. H. H	R. H. H	R. H. H	R. H. H	R. H. H	R. H. H	R. H. H	R. H. H	R. H. H	R. H. H	R. H. H
TRAINING OFFICER					S. G. G	S. G. G	S. G. G	S. G. G	S. G. G	S. G. G	S. G. G	S. G. G	S. G. G	S. G. G	S. G. G	S. G. G	S. G. G	S. G. G
PRINCIPAL					<i>[Signature]</i>	<i>[Signature]</i>	<i>[Signature]</i>	<i>[Signature]</i>	<i>[Signature]</i>	<i>[Signature]</i>	<i>[Signature]</i>	<i>[Signature]</i>	<i>[Signature]</i>	<i>[Signature]</i>	<i>[Signature]</i>	<i>[Signature]</i>	<i>[Signature]</i>	<i>[Signature]</i>



[Signature]
 PRINCIPAL
 K.S.R. COLLEGE OF ENGINEERING
 K.S.R. KALVI NAGAR,
 TIRUCHENGODE-637 215

K.S.R. COLLEGE OF ENGINEERING (AUTONOMOUS), TIRUCHENGODE - 637 215
TRAINING AND PLACEMENT
TECHNICAL (INTERNAL) TRAINING ECE ATTENDANCE DETAILS -2023 BATCH

Mr MUTHUKUMARAN

S. No	REG NO	NAME	DATE	BRANCH	BATCH	23.02.2022		24.02.2022		25.02.2022		26.02.2022		28.02.22	
						FN	AN	FN	AN	FN	AN	FN	AN	FN	AN
						1	1915002	ARAVINTHAN T	ECE	BATCH 3	/	/	/	/	/
2	1915009	GOWRIMANOHARI S	ECE	BATCH 3	/	/	/	/	/	/	/	/	/	/	
3	1915025	KISHORE D	ECE	BATCH 3	/	/	/	/	/	/	a	a	/	/	
4	1915036	MONISHA D	ECE	BATCH 3	/	/	/	/	/	/	/	/	/	/	
5	1915038	NAVEENA. M	ECE	BATCH 3	/	/	/	/	/	/	/	/	/	/	
6	1915049	SAKTHISREE M	ECE	BATCH 3	/	/	/	/	/	/	a	a	/	/	
7	1915055	SHARAN S	ECE	BATCH 3	/	/	/	/	/	/	/	/	/	/	
8	1915059	SREE GANESH M	ECE	BATCH 3	/	/	/	/	/	/	/	/	/	/	
9	1915061	SUBASHINI E	ECE	BATCH 3	/	/	/	/	/	/	/	/	/	/	
10	1915075	YOGESH. R	ECE	BATCH 3	/	/	/	/	/	/	/	/	a	a	
11	1915003	ARUNKUMAR S	ECE	BATCH 3	/	/	/	/	/	/	/	/	/	/	
12	1915030	MAGIBALAN R	ECE	BATCH 3	/	/	/	/	/	/	/	/	/	/	
13	1915033	MOHAN S	ECE	BATCH 3	/	/	/	/	/	/	/	/	/	/	
14	1915034	MOHANASELVAN.D.V	ECE	BATCH 3	/	/	/	/	/	/	/	/	/	/	
15	1915035	MOHANPRASATH.A	ECE	BATCH 3	/	/	/	/	/	/	/	/	/	/	
16	1915039	PERUMAL R	ECE	BATCH 3	/	/	/	/	/	/	/	/	/	/	
17	1915052	SELVA PRAVEEN S	ECE	BATCH 3	/	/	/	/	/	/	/	/	/	/	
TOTAL						17	17	17	17	17	17	17	17	17	17
PRESENT						-	-	-	-	-	-	15	17	16	16
ABSENT						-	-	-	-	-	-	02	00	01	01
PLACEMENT CO ORDINATOR SIGN						<i>[Signature]</i>	<i>[Signature]</i>	<i>[Signature]</i>	<i>[Signature]</i>	<i>[Signature]</i>	<i>[Signature]</i>	<i>[Signature]</i>	<i>[Signature]</i>	<i>[Signature]</i>	<i>[Signature]</i>
HOD SIGN						<i>[Signature]</i>	<i>[Signature]</i>	<i>[Signature]</i>	<i>[Signature]</i>	<i>[Signature]</i>	<i>[Signature]</i>	<i>[Signature]</i>	<i>[Signature]</i>	<i>[Signature]</i>	<i>[Signature]</i>
TRAINING OFFICER						<i>[Signature]</i>	<i>[Signature]</i>	<i>[Signature]</i>	<i>[Signature]</i>	<i>[Signature]</i>	<i>[Signature]</i>	<i>[Signature]</i>	<i>[Signature]</i>	<i>[Signature]</i>	<i>[Signature]</i>
PRINCIPAL						<i>[Signature]</i>	<i>[Signature]</i>	<i>[Signature]</i>	<i>[Signature]</i>	<i>[Signature]</i>	<i>[Signature]</i>	<i>[Signature]</i>	<i>[Signature]</i>	<i>[Signature]</i>	<i>[Signature]</i>

[Signature]
PRINCIPAL
K.S.R. COLLEGE OF ENGINEERING
K.S.R. KALVI NAGAR,
TIRUCHENGODE-637 215



K.S.R. COLLEGE OF ENGINEERING (AUTONOMOUS), TIRUCHENGODE - 637 215

TRAINING AND PLACEMENT

TECHNICAL (INTERNAL) TRAINING ECE ATTENDANCE DETAILS -2023 BATCH

S. No	REG NO	NAME	DATE	BATCH	23.02.2022		24.02.2022		25.02.2022		26.02.2022	
					FN	AN	FN	AN	FN	AN	FN	AN
1	1915004	ASHOKKUMAR K	ECE	BATCH 2	/	/	/	/	/	/	a	a
2	1915006	DINESH S	ECE	BATCH 2	/	/	/	/	/	/	/	/
3	1915007	DINESHKUMAR T	ECE	BATCH 2	/	/	/	/	/	/	a	a
4	1915008	DIWAHAR S J	ECE	BATCH 2	/	/	/	/	a	a	/	/
5	1915010	GOWTHAM R	ECE	BATCH 2	/	/	/	/	a	/	a	a
6	1915011	ILAVARASAN K	ECE	BATCH 2	/	/	/	/	/	/	/	/
7	1915012	INDUMATHI J	ECE	BATCH 2	a	a	a	a	/	/	a	a
8	1915013	JAGADEEP S	ECE	BATCH 2	a	a	/	/	/	/	/	/
9	1915015	JAYAPRAKASH. M	ECE	BATCH 2	/	/	/	/	/	/	/	/
10	1915016	JEEVANANDHAM.C.P	ECE	BATCH 2	/	/	/	/	a	a	/	/
11	1915017	KALIDAS M	ECE	BATCH 2	a	a	/	/	a	a	/	/
12	1915018	KAMARAJ J	ECE	BATCH 2	/	/	/	/	/	/	/	/
13	1915019	KARTHIKA DEVI. K	ECE	BATCH 2	/	/	/	/	/	/	/	/
14	1915020	KAVIN M	ECE	BATCH 2	/	/	/	/	a	/	/	/
15	1915021	KAVINESH K	ECE	BATCH 2	/	/	/	/	a	/	/	/
16	1915022	KAVINMUTHU S	ECE	BATCH 2	a	a	/	/	a	/	/	/
17	1915024	KIRANRAJ T	ECE	BATCH 2	/	/	/	/	/	/	/	/
18	1915026	KUMAR.S	ECE	BATCH 2	/	/	/	/	a	/	/	/
19	1915027	LINGESH S	ECE	BATCH 2	/	/	/	/	/	/	/	/
20	1915028	LOGESH S D	ECE	BATCH 2	/	/	/	/	/	/	a	/
21	1915029	LOKENDRAN S	ECE	BATCH 2	/	/	/	/	/	/	a	a
22	1915032	MANOJ T	ECE	BATCH 2	/	/	/	/	/	/	/	/
23	1915040	PRABAKARAN R	ECE	BATCH 2	/	/	/	/	/	/	/	/
24	1915041	PRADEEPA S	ECE	BATCH 2	a	a	a	a	a	a	a	a
25	1915043	PRITHIVRAJ T	ECE	BATCH 2	/	/	/	/	/	/	/	/

PRINCIPAL

K.S.R. COLLEGE OF ENGINEERING

K.S.R. KALVI NAGAR,

TIRUCHENGODE-637 215

26	1915044	PRIYADHARSHINI.V	ECE	BATCH 2	a	a	a	a	a	a	/	/
27	1915045	RAGUL.T	ECE	BATCH 2	/	/	/	/	/	/	/	/
28	1915050	SANJAY R	ECE	BATCH 2	/	/	/	/	/	/	/	/
29	1915053	SETHU B	ECE	BATCH 2	/	/	/	/	/	/	/	/
30	1915063	SUKUMAR V	ECE	BATCH 2	a	a	/	/	a	a	a	a
31	1915064	SUSHMA.S	ECE	BATCH 2	/	/	/	/	/	/	/	/
32	1915066	TAMILARASU. M	ECE	BATCH 2	a	a	/	/	a	/	/	/
33	1915068	THILAGA S	ECE	BATCH 2	a	a	a	a	aa	a	a	a
34	1915069	THILAKBALAJI SM	ECE	BATCH 2	/	/	/	/	/	/	/	/
35	1915070	THIRUMURUGAN V	ECE	BATCH 2	a	a	a	a	a	a	a	a
36	1915071	VASANTH R	ECE	BATCH 2	a	a	a	a	a	a	a	a
37	1915072	VIGNESH V	ECE	BATCH 2	a	a	a	a	a	a	a	a
38	1915074	VINOTHINI G	ECE	BATCH 2	/	/	/	/	/	/	/	/
39	1915501	SABARI.M	ECE	BATCH 2	a	a	a	a	a	a	a	a
40	1915502	SREE HARISH N	ECE	BATCH 2	/	/	/	/	/	/	a	a
41	1915503	TAMILSHRI S	ECE	BATCH 2	/	/	/	/	a	a	/	/
TOTAL					41	41	41	41	41	41	41	41
PRESENT					28	28	32	33	21	31	29	29
ABSENT					13	13	8	8	9	10	12	12
PLACEMENT CO ORDINATOR SIGN					<i>[Signature]</i>	<i>[Signature]</i>	<i>[Signature]</i>	<i>[Signature]</i>	<i>[Signature]</i>	<i>[Signature]</i>	<i>[Signature]</i>	<i>[Signature]</i>
HOD SIGN					<i>[Signature]</i>	<i>[Signature]</i>	<i>[Signature]</i>	<i>[Signature]</i>	<i>[Signature]</i>	<i>[Signature]</i>	<i>[Signature]</i>	<i>[Signature]</i>
TRAINING OFFICER					<i>[Signature]</i>	<i>[Signature]</i>	<i>[Signature]</i>	<i>[Signature]</i>	<i>[Signature]</i>	<i>[Signature]</i>	<i>[Signature]</i>	<i>[Signature]</i>
PRINCIPAL					<i>[Signature]</i>	<i>[Signature]</i>	<i>[Signature]</i>	<i>[Signature]</i>	<i>[Signature]</i>	<i>[Signature]</i>	<i>[Signature]</i>	<i>[Signature]</i>

PRINCIPAL
K.S.R. COLLEGE OF ENGINEERING
K.S.R. KAI VI NAGAR,
TIRUCHENGODE-637

28	1914041	SIVAKUMAR S	EEE	BATCH 2	/	/	/	/	/	/	/	/	/
29	1914042	SOMESHKANNAN V	EEE	BATCH 2	/	/	/	/	/	/	/	/	/
30	1914044	SUBASH G	ECE	BATCH 2	a	a	a	a	a	a	a	a	a
31	1914043	SRIDHAR A	EEC	BATCH 2	/	/	/	/	/	/	/	/	/
32	1914047	THANUJA G V	EEE	BATCH 2	a	a	a	a	a	a	/	/	/
33	1914048	THULASIRAMAN P	EEE	BATCH 2	a	a	a	a	a	a	a	a	a
34	1914049	VIGNESH E	EEE	BATCH 2	/	/	/	/	/	/	/	/	/
35	1914050	VIJAY KUMAR B	EEE	BATCH 2	a	a	a	a	a	a	a	a	a
36	1914051	YOGESHRAJ P	EEE	BATCH 2	a	a	/	/	/	/	/	/	/
37	1914508	NAVANEETHAKRISHNAN	EEE	BATCH 2	/	/	/	/	/	/	a	a	/
TOTAL													
PRESENT													
ABSENT													
PLACEMENT CO ORDINATOR SIGN					<i>[Signature]</i>	<i>[Signature]</i>	<i>[Signature]</i>	<i>[Signature]</i>	<i>[Signature]</i>	<i>[Signature]</i>	<i>[Signature]</i>	<i>[Signature]</i>	<i>[Signature]</i>
HOD SIGN					<i>[Signature]</i>	<i>[Signature]</i>	<i>[Signature]</i>	<i>[Signature]</i>	<i>[Signature]</i>	<i>[Signature]</i>	<i>[Signature]</i>	<i>[Signature]</i>	<i>[Signature]</i>
TRAINING OFFICER					<i>[Signature]</i>	<i>[Signature]</i>	<i>[Signature]</i>	<i>[Signature]</i>	<i>[Signature]</i>	<i>[Signature]</i>	<i>[Signature]</i>	<i>[Signature]</i>	<i>[Signature]</i>
PRINCIPAL					<i>[Signature]</i>	<i>[Signature]</i>	<i>[Signature]</i>	<i>[Signature]</i>	<i>[Signature]</i>	<i>[Signature]</i>	<i>[Signature]</i>	<i>[Signature]</i>	<i>[Signature]</i>

FN AN

/ /
/ /
a o
/ /
/ /
a a
/ /
a a
a a
/ /

38. 1914046 SURYA PRAKASH.S
39. 1914039 SATHISH KUMAR

EEE BATCH 2 / / / / / / / / / /
EEE BATCH 2 / / / / / / / / / /

[Signature]
PRINCIPAL
K.S.R. COLLEGE OF ENGINEERING
K.S.R. KALVI NAGAR,
TIRUCHENGODE-637 215.

1921015 Dinesh ✓
 1921058 Thirakaran ✓
 1921059 Vijay ✓

a a a a a a / /
 a a a a a a / /
 / / / / / / / /

28	1921035	Prabhu.G	IT	BATCH 3	a	a	a	a	a	a	/	/
29	1921037	Promoth Mahajan	IT	BATCH 3	/	/	/	/	/	/	/	/
30	1921038	Pushparaj D ✓	IT	BATCH 3	/	/	/	/	/	/	/	/
31	1921039	Ragul. G ✓	IT	BATCH 3	/	/	/	/	a	a	/	/
32	1921040	B Rahul	IT	BATCH 3	/	/	/	/	/	/	/	/
33	1921041	S.Rajkumar	IT	BATCH 3	/	/	/	/	/	/	/	/
34	1921042	RameshKrishnan M ✓	IT	BATCH 3	/	/	/	/	/	/	/	/
35	1921043	Ranjith kumar. T ✓	IT	BATCH 3	a	a	a	a	/	/	/	/
36	1921045	Saravanan B ✓	IT	BATCH 3	a	a	a	a	a	a	a	/
37	1921046	Sasidharan.S ✓	IT	BATCH 3	/	/	/	/	/	/	/	/
38	1921047	B.sneka ✓	IT	BATCH 3	/	/	/	/	/	/	/	/
39	1921048	Sohail Ahmed M ✓	IT	BATCH 3	a	a	a	a	a	a	a	a
40	1921049	Soundar M ✓	IT	BATCH 3	/	/	/	/	/	/	/	/
41	1921051	N Sowmiya ✓	IT	BATCH 3	/	/	/	/	/	/	/	/
42	1921052	Steffi Graf.R ✓	IT	BATCH 3	/	/	/	/	/	/	/	/
43	1921053	Suman.k.s ✓	IT	BATCH 3	a	a	/	/	/	/	a	a
44	1921055	Surya ✓	IT	BATCH 3	a	a	a	a	a	a	/	/
45	1921056	P.Thaniyeal ✓	IT	BATCH 3	/	/	/	/	/	/	/	/
46	1921057	P.S.Thavanish ✓	IT	BATCH 3	/	/	/	/	/	/	/	/
47	1921060	B.Vishnu ✓	IT	BATCH 3	a	a	a	a	/	/	/	/
48	1921050	B.Sowmiya ✓	IT	BATCH 3	/	/	/	/	/	/	/	/
49	1921044	G.Santhosh ✓	IT	BATCH 3	/	/	/	/	/	/	/	/
50	1921054	J.Sureendhar ✓	IT	BATCH 3	/	/	/	/	/	/	a	a
51	1921036	Prasanth.R ✓	IT	BATCH 3	a	a	/	/	/	/	/	/
52	1921029	Nallasivamani P ✓	IT	BATCH 3	a	a	a	a	a	a	/	/
TOTAL					52	53	53	53	52	52	58	58
PRESENT					40	40	41	41	42	42	46	46
ABSENT					13	13	12	12	11	11	7	7
PLACEMENT CO ORDINATOR SIGN												
HOD SIGN												
TRAINING OFFICER												
PRINCIPAL												

K.S.R. COLLEGE OF ENGINEERING (AUTONOMOUS), TIRUCHENGODE - 637 215

TRAINING AND PLACEMENT

TECHNICAL (INTERNAL) TRAINING MECH ATTENDANCE DETAILS -2023 BATCH

S. No	REG NO	NAME	DATE	BATCH	23.02.2022		24.02.2022		25.02.2022		26.02.2022		28.02.2022	
					FN	AN	FN	AN	FN	AN	FN	AN	FN	AN
1	1916013	GNANASELVARAJ P	MECH	BATCH 4	✓	✓	✓	✓	✓	✓	✓	✓	✓	✓
2	1916018	GUHAN P	MECH	BATCH 4	a	a	a	a	a	a	a	a	a	a
3	1916020	KAMESH S	MECH	BATCH 4	a	a	a	a	a	a	a	a	a	a
4	1916021	KAVI M	MECH	BATCH 4	✓	✓	✓	✓	✓	✓	✓	✓	✓	✓
5	1916053	VELMURUGAN.A	MECH	BATCH 4	✓	✓	✓	✓	✓	✓	✓	✓	✓	✓
6	1916502	ARUNKUMAR M	MECH	BATCH 4	✓	✓	✓	✓	✓	✓	a	a	✓	✓
7	1916505	DHARUNPRASATH.V	MECH	BATCH 4	✓	✓	✓	✓	✓	✓	✓	✓	✓	✓
8	1916513	KISHORE G	MECH	BATCH 4	a	a	a	a	a	a	a	a	a	a
9	1916514	LOGESHWARAN M	MECH	BATCH 4	✓	✓	✓	✓	✓	✓	✓	✓	✓	✓
10	1916515	MAKESKUMAR C	MECH	BATCH 4	✓	✓	✓	✓	✓	✓	✓	✓	✓	✓
11	1916516	MANOJ G	MECH	BATCH 4	a	a	✓	✓	✓	✓	✓	✓	✓	✓
12	1916517	MOHANRAJA R	MECH	BATCH 4	✓	✓	✓	✓	✓	✓	✓	✓	✓	✓
13	1916520	NANDHAKUMAR S	MECH	BATCH 4	✓	✓	✓	✓	✓	✓	✓	✓	✓	✓
14	1916521	NAVEENKUMAR P	MECH	BATCH 4	✓	✓	✓	✓	✓	✓	✓	✓	✓	✓
15	1916024	KAVINESH S	MECH	BATCH 4	✓	✓	✓	✓	✓	✓	a	a	✓	✓
16	1916525	SAKTHIVEL.K	MECH	BATCH 4	✓	✓	✓	✓	✓	✓	✓	✓	✓	✓
17	1916526	SAKTHIVELAN N	MECH	BATCH 4	✓	✓	✓	✓	✓	✓	✓	✓	✓	✓
18	1916533	VASANTHAKUMAR K	MECH	BATCH 4	✓	✓	✓	✓	✓	✓	✓	✓	✓	✓
19	1916582	TAMILINIYAN.R	MECH	BATCH 4	a	a	a	a	a	a	a	a	a	a
TOTAL					19	19	19	19	19	19	19	19	19	19
PRESENT					14	14	15	15	15	15	14	14	17	17
ABSENT					5	5	4	4	4	4	5	5	2	2
PLACEMENT CO ORDINATOR SIGN					✓	✓	✓	✓	✓	✓	✓	✓	✓	✓
HOD SIGN					✓	✓	✓	✓	✓	✓	✓	✓	✓	✓
TRAINING OFFICER					✓	✓	✓	✓	✓	✓	✓	✓	✓	✓

[Handwritten Signature]

PRINCIPAL
K.S.R. COLLEGE OF ENGINEERING
K.S.R. KALVI NAGAR,
TIRUCHENGODE-637 215



K.S.R. COLLEGE OF ENGINEERING (AUTONOMOUS), TIRUCHENGODE - 637 215

TRAINING AND PLACEMENT

APTITUDE (INTERNAL) TRAINING MCA ATTENDANCE DETAILS -2023 BATCH

S. No	REG NO	NAME	DATE	BATCH	23.02.2022		24.02.2022		25.02.2022		26.02.2022	
					FN	AN	FN	AN	FN	AN	FN	AN
1	2162001	ANBUMANI K R	MCA	BATCH 4	/	/	/	/	/	/	a	a
(2)	2162002	ANIRRITHA A	MCA	BATCH 4	a	a	a	a	a	a	a	a
3	2162003	ARUN PRASANTH K	MCA	BATCH 4	/	/	/	/	/	/	/	/
4	2162004	BALAJI V	MCA	BATCH 4	/	/	/	/	/	/	/	/
5	2162005	BHARANIDHARAN B	MCA	BATCH 4	/	/	/	/	/	/	a	a
6	2162006	DHARSHINI B	MCA	BATCH 4	a	a	/	/	/	/	/	/
(7)	2162007	DHINESHKUMAR D	MCA	BATCH 4	a	a	a	a	a	a	a	a
8	2162008	DHINESHKUMAR S	MCA	BATCH 4	/	/	/	/	/	/	a	a
9	2162009	DHIVAKAR P	MCA	BATCH 4	/	/	/	/	/	/	/	/
10	2162010	DHIVYA SRI K	MCA	BATCH 4	a	a	/	/	/	/	/	/
11	2162011	DINESH N	MCA	BATCH 4	/	/	/	/	/	/	/	/
12	2162012	DINESH S	MCA	BATCH 4	/	/	/	/	/	/	a	a
13	2162013	GANAPATHI P	MCA	BATCH 4	/	/	/	/	/	/	/	/
14	2162014	GOKUL S	MCA	BATCH 4	/	/	/	/	/	/	a	a
15	2162015	GOMATHI S	MCA	BATCH 4	a	a	a	a	a	a	a	a
16	2162016	HARIDHARAN K	MCA	BATCH 4	/	/	a	a	/	/	/	/
17	2162017	HARIHARAN S	MCA	BATCH 4	a	a	/	/	/	/	/	/
18	2162018	HARISH RAGAVENDRAA K	MCA	BATCH 4	/	/	a	a	/	/	/	/
19	2162019	HARISHH J	MCA	BATCH 4	/	/	/	/	/	/	/	/
20	2162020	JAYABALAAGI K S	MCA	BATCH 4	/	/	/	/	/	/	/	/
21	2162021	KARTHICK RAJA S	MCA	BATCH 4	a	a	/	/	/	/	a	a
22	2162022	KAVIYA G	MCA	BATCH 4	a	a	/	/	/	/	/	/
23	2162023	KESAVAN G R	MCA	BATCH 4	/	/	a	a	/	/	/	/
24	2162025	LOGARAJ C	MCA	BATCH 4	/	/	/	/	/	/	/	/
25	2162026	LOKESHWARASARAVANAN P	MCA	BATCH 4	/	/	/	/	/	/	/	/
26	2162027	MAKEELESWARAN	MCA	BATCH 4	a	a	/	/	/	/	/	/
27	2162028	MANISH KULANDAI RAJ D	MCA	BATCH 4	/	/	/	/	/	/	/	/
28	2162029	NAVEEN KUMAR V	MCA	BATCH 4	/	/	/	/	/	/	/	/
29	2162030	NAVEEN P	MCA	BATCH 4	/	/	/	/	/	/	/	/
30	2162031	PRABU M	MCA	BATCH 4	a	a	/	/	/	/	/	/

 PRINCIPAL
 K.S.R. COLLEGE OF ENGINEERING
 K.S.R. KALVI NAGAR,
 TIRUCHENGODE-637 215

31	2162032	PRADEEP T	MCA	BATCH 4	/	/	/	/	/	/	/	/
32	2162033	PRASANTH B	MCA	BATCH 4	a	a	a	a	/	/	/	/
33	2162034	PRATHEEP M	MCA	BATCH 4	/	/	/	/	/	/	/	/
34	2162035	PRAVEEN M	MCA	BATCH 4	/	/	a	a	/	/	/	/
35	2162036	PREETHI V	MCA	BATCH 4	/	/	/	/	/	/	/	/
36	2162037	RANJANA P	MCA	BATCH 4	a	a	/	/	/	/	/	/
37	2162038	ROGEEETH NARAYANAN V S	MCA	BATCH 4	/	/	/	/	/	/	/	/
38	2162039	SAKTHI V A	MCA	BATCH 4	/	/	a	a	/	/	/	/
39	2162040	SANDEEP RAI R	MCA	BATCH 4	/	/	/	/	/	/	/	/
40	2162041	SANJAI A	MCA	BATCH 4	/	/	/	/	/	/	a	a
41	2162042	SASIESWARAN C	MCA	BATCH 4	/	/	/	/	/	/	/	/
42	2162044	SIVAKUMAR T	MCA	BATCH 4	a	a	/	/	/	/	/	/
43	2162045	SIVARANGANATHAN K	MCA	BATCH 4	/	/	/	/	/	/	/	/
44	2162046	SIVASAKTHI M	MCA	BATCH 4	/	/	/	/	/	/	/	/
45	2162047	SIVASHANKAR R	MCA	BATCH 4	/	/	/	/	/	/	a	a
46	2162048	SOMASUNDAR G	MCA	BATCH 4	/	/	/	/	/	/	/	/
47	2162049	SOWMIYA A	MCA	BATCH 4	/	/	/	/	/	/	/	/
48	2162050	SOWNDARRAIAN N	MCA	BATCH 4	/	/	/	/	/	/	/	/
49	2162051	SOWNTHARYA G	MCA	BATCH 4	/	/	/	/	/	/	/	/
50	2162052	SURYA M	MCA	BATCH 4	/	/	a	a	/	/	a	a
51	2162053	THIYAGARAI S	MCA	BATCH 4	/	/	/	/	/	/	/	/
52	2162054	VASANTHAKUMAR R	MCA	BATCH 4	/	/	/	/	/	/	/	/
53	2162055	VASANTHAKUMAR R	MCA	BATCH 4	/	/	/	/	/	/	/	/
54	2162056	VENKATESH B	MCA	BATCH 4	/	/	/	/	/	/	/	/
55	2162057	VIDHYADHARAN P	MCA	BATCH 4	/	/	/	/	/	/	/	/
56	2162058	VINOTHKUMAR T	MCA	BATCH 4	/	/	/	/	/	/	/	/
57	2162059	VISHWA K	MCA	BATCH 4	/	/	/	/	/	/	a	a
58	2162060	YOGESHWARAN S K	MCA	BATCH 4	/	/	/	/	/	/	a	a
TOTAL					58	58	58	58	58	58	58	58
PRESENT					45	45	48	48	55	55	44	44
ABSENT					13	13	10	10	3	3	14	14
PLACEMENT CO ORDINATOR SIGN												
HOD SIGN												
TRAINING OFFICER												
PRINCIPAL												

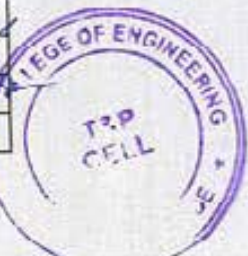

KSR College of Engineering (Autonomous), Tiruchengode – 637 215

, Training and Placement Cell

Phase – 1 Aptitude Training Schedule for 2023 Batch

DATE	FN	AN
23.02.2022	Number System	Number System
24.02.2022	Percentage	Percentage
25.02.2022	Ratio Proportions	Ratio Proportions
26.02.2022	Time Speed and Distance	Time Speed and Distance
28.02.2022	Permutation and Combination	Permutation and Combination
01.03.2022	Blood Relation	Blood Relation
02.03.2022	Syllogism	Syllogism
03.03.2022	Average	Average
04.03.2022	Profit and Loss	Profit and Loss
05.03.2022	Problems on Ages	Problems on Ages
07.03.2022	Time and Work	Time and Work
08.03.2022	Probability	Probability
09.03.2022	Directions	Directions
10.03.2022	Coding and Decoding	Coding and Decoding
11.03.2022	Clocks and Calendars	Clocks and Calendars
12.03.2022	Boats and Streams	Boats and Streams

FN Session

9.30 am to 12.30 pm

AN Session

01.30 pm to 04.00 pm

Assessment:

04.30 pm to 06.00 pm

*10.46 am – 11.00am - Break

*12.30 pm – 01.30 pm -Lunch Break

* 02.46 pm – 03.00 pm – Break

S. Gnanajayam
21 Feb 22



PRINCIPAL
K.S.R. COLLEGE OF ENGINEERING
K.S.R. KALVI NAGAR,
TIRUCHENGODE-637 215



KSRCE/QM/8.6/22/PDC

K.S.R. COLLEGE OF ENGINEERING

(Autonomous)

TIRUCHENGODE - 637 215 TAMILNADU, INDIA

Approved by AICTE, New Delhi, Anna University, Chennai & Accredited by NBA and NAAC with 'A' Grade

Professionals Development Cell

Certificate of Participation

This is to certify that ~~Mr.~~/Ms. CHITRA S.....
of INFORMATION TECHNOLOGY..... department has participated in the
..... TRAINING PROGRAMME.....
programme held at TRAINING AND PLACEMENT CELL - KSRCE.....
on 23.2.22 - 10.3.22 . We wish the student all success.

Date: 10.03.2022

Organizer

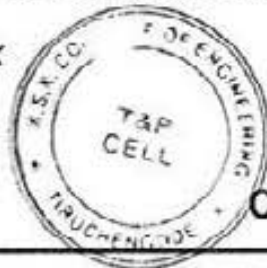

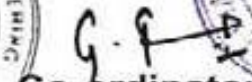
Co-ordinator



Principal
K.S.R. COLLEGE OF ENGINEERING
K.S.R. KALVI NAGAR,
TIRUCHENGODE-637 215



HIGHER
EDUCATIONAL
CELL





K.S.R. COLLEGE OF ENGINEERING

(Autonomous)

TIRUCHENGODE - 637 215, TAMILNADU, INDIA.

Approved by AICTE, New Delhi, Anna University, Chennai & Accredited by NBA and NAAC with 'A' Grade

Professionals Development Cell

Certificate of Participation

This is to certify that Mr./Ms. DIVAGAR D.

of ELECTRICAL AND ELECTRONICS ENGINEERING department has participated in the

TRAINING PROGRAMME

programme held at TRAINING AND PLACEMENT CELL - KSRCE

on 23.2.22 - 10.3.22. We wish the student all success.

Date: 10.3.22

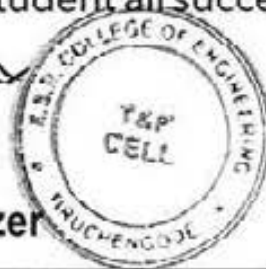
Organizer 

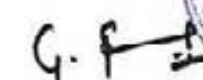
Co-ordinator 

Principal 
K.S.R. COLLEGE OF ENGINEERING
K.S.R. KALVI NAGAR
TIRUCHENGODE-637 215



HIGHER EDUCATIONAL CELL





KSRCE/QM/8.6/22/PDC

K.S.R. COLLEGE OF ENGINEERING

(Autonomous)

TIRUCHENGODE - 637 215. TAMILNADU, INDIA.

Approved by AICTE, New Delhi, Anna University, Chennai & Accredited by NBA and NAAC with 'A' Grade

Professionals Development Cell

Certificate of Participation

This is to certify that Mr./Ms.....SHARAN...S.....
 of ELECTRONICS AND COMMUNICATION ENGINEERING.....department has participated in the
TRAINING PROGRAMME.....
 programme held atTRAINING AND PLACEMENT CELL - KSRCE.....
 on 23.2.22 - 10.3.22. We wish the student all success.

Date: 10.3.2022

[Signature]
 Organizer

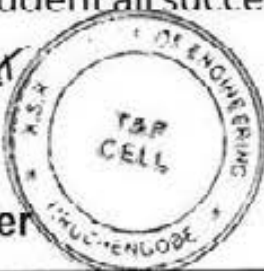

[Signature]
 Co-ordinator



[Signature]
 Principal

K.S.R. COLLEGE OF ENGINEERING
 K.S.R. KALVI NAGAR
 TIRUCHENGODE - 637 215



HIGHER EDUCATIONAL CELL





KSRCE/QM/8.6/22/PDC

K.S.R. COLLEGE OF ENGINEERING

(Autonomous)

TIRUCHENGODE - 637 215, TAMILNADU, INDIA.

Approved by AICTE, New Delhi, Anna University, Chennai & Accredited by NBA and NAAC with 'A' Grade

Professionals Development Cell

Certificate of Participation

This is to certify that Mr./Ms. SUGUMAR D of AUTOMOBILE ENGINEERING department has participated in the TRAINING PROGRAMME programme held at TRAINING AND PLACEMENT CELL - KSRCE on 23.2.22 - 10.3.22. We wish the student all success.

Date: 10.3.2022
 Organizer: [Signature]

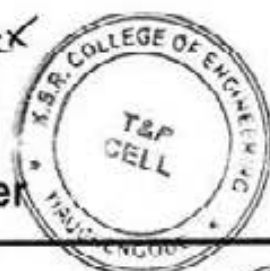

Co-ordinator: [Signature]



Principal: [Signature]
 K.S.R. COLLEGE OF ENGINEERING
 K.S.R. KALVI NAGAR
 TIRUCHENGODE-637 215



HIGHER EDUCATIONAL CELL



2021-2022 (25)

KSRCE/IQAC/2021-2022/T&PIC26C-64/42

K.S.R. COLLEGE OF ENGINEERING, TIRUCHENGODE - 637 215
(Autonomous)

DATE: 11.03.2022

TIME: 03.00 p.m.

CIRCULAR

CLASSIFICATION	ROUTINE	IMMEDIATE
ORIGINATOR: PRINCIPAL		CIRCULATED TO: All UG HoDs

Sub.: IT Specific Training for all UG Pre Final Year Students (2023 Batch) - Reg.

IT Specific Training for all UG Pre Final Year Students (2023 Batch) has been organized by Central Placement Cell from 14th March 2022 to 26th March 2022 (12 Days). The morning session will be conducted from 09.00 am to 12.30 pm, the afternoon session will be from 01.30 pm to 07.00 pm. So, all the regular classes will be cancelled for the training program. Concerned HoDs are requested to instruct their students to attend the whole training without fail.

Instructions to the Faculty through HoDs

1. All the Department T&P Co-ordinators are requested to monitor the attendance & discipline matters throughout the training program and update the HoDs concerned every day.

Instructions to the Students through Department T&P Co-ordinators & HoDs

1. Dress Code (Self Grooming, Formalwear with shoes)
2. Discipline
3. Punctuality

If any student not follows the above he/she may not be allowed to proceed further.

TRAINING OFFICER

PRINCIPAL

Copy to:

1. All UG HODS for favor of information and circulation among current pre final year students and faculty members concerned.
2. All Training & Placement Coordinators.
3. Department Notice board.



EVIDENCE OF COMPLETION

Number of persons not received / seen: _____

Signature of Originator with date and time: _____

PRINCIPAL
K.S.R. COLLEGE OF ENGINEERING
K.S.R. KALVI NAGAR,
TIRUCHENGODE-637 215

K.S.R. COLLEGE OF ENGINEERING (AUTONOMOUS), TIRUCHENGODE - 637 215

TRAINING & PLACEMENT CELL

EXTERNAL TRAINING STUDENTS NAME LIST (2021 - 2023 BATCH)

S. NO	REG. NO	NAME	DEPARTMENT	BATCH	PHONE
1	1913001	AATHMIGA M	CSE	BATCH 1	F201
2	1913002	ABISHEK	CSE	BATCH 1	F201
3	1913003	R.ADITYA	CSE	BATCH 1	F201
4	1913004	AJAIMARUDHU V	CSE	BATCH 1	F201
5	1913007	ARAVINTH. M	CSE	BATCH 1	F201
6	1913008	ARULMURUGAN S	CSE	BATCH 1	F201
7	1913009	ARUN. AP	CSE	BATCH 1	F201
8	1913010	ASIK.A	CSE	BATCH 1	F201
9	1913013	R. BHARATH KISHORE	CSE	BATCH 1	F201
10	1913014	CHANDRU KANNA R	CSE	BATCH 1	F201
11	1913015	DEEPASRI M	CSE	BATCH 1	F201
12	1913016	DEEPIKA.V	CSE	BATCH 1	F201
13	1913017	M.DHARUN	CSE	BATCH 1	F201
14	1913018	DHINESH U	CSE	BATCH 1	F201
15	1913019	DHIVYABHARATHI S	CSE	BATCH 1	F201
16	1913020	DHIVYA M	CSE	BATCH 1	F201
17	1913021	DINESH BABU SM	CSE	BATCH 1	F201
18	1913022	DINESH KUMAR M	CSE	BATCH 1	F201
19	1913024	DIVYADHARSHINI T	CSE	BATCH 1	F201
20	1913025	GANESAN K	CSE	BATCH 1	F201
21	1913028	GOKULRAJA L P	CSE	BATCH 1	F201
22	1913029	M. HARIHARAN	CSE	BATCH 1	F201

PRINCIPAL
K.S.R. COLLEGE OF ENGINEERING
K.S.R. KALVI NAGAR,
TIRUCHENGODE-637 215

K.S.R EDUCATIONAL INSTITUTIONS,TIRUCHENGODE - 637215

Central Placement Cell

KSRCE - IT Service Specific Training 2022 for 2023 Batch (14.03.2022 to 25.03.2022) Batch 2 (Hall No : F202)

S.No	Reg No	Name	College	Branch	14.03.2022			15.03.2022			16.03.2022			17.03.2022			18.03.2022			19.03.2022			21.03.2022			22.03.2022			23.03.2022			24.03.2022			25.03.2022					
					FN	AN	Test	FN	AN	Test	FN	AN	Test	FN	AN	Test	FN	AN	Test	FN	AN	Test	FN	AN	Test	FN	AN	Test	FN	AN	Test	FN	AN	Test	FN	AN	Test			
1	1911001	BALACHANDAR A	KSRCE	AUTO	P	P	P	P	P	P	P	P	P	P	P	P	P	P	P	P	P	P	P	P	P	P	P	P	P	P	P	P	P	P	P	P	P			
2	1911006	GOKULPRANESH C	KSRCE	AUTO	P	P	P	P	P	P	P	P	P	P	P	P	P	P	P	P	P	P	P	P	P	P	P	P	P	P	P	P	P	P	P	P	P			
3	1911008	HARIGANESH V	KSRCE	AUTO	P	P	P	P	P	P	P	P	P	P	P	P	P	P	P	P	P	P	P	P	P	P	P	P	P	P	P	P	P	P	P	P	P			
4	1911015	NITHYASHREE R	KSRCE	AUTO	P	P	P	P	P	P	P	P	P	P	P	P	P	P	P	P	P	P	P	P	P	P	P	P	P	P	P	P	P	P	P	P	P			
5	1911023	SUGUMAR D	KSRCE	AUTO	P	P	P	P	P	P	P	P	P	P	P	P	P	P	P	P	P	P	P	P	P	P	P	P	P	P	P	P	P	P	P	P	P			
6	1911024	SUJEETH N	KSRCE	AUTO	P	P	P	P	P	P	P	P	P	P	P	P	P	P	P	P	P	P	P	P	P	P	P	P	P	P	P	P	P	P	P	P	P			
7	1911026	VIJAY P	KSRCE	AUTO	P	P	P	P	P	P	P	P	P	P	P	P	P	P	P	P	P	P	P	P	P	P	P	P	P	P	P	P	P	P	P	P	P			
TOTAL					7	7	7	7	7	7	7	7	7	7	7	7	7	7	7	7	7	7	7	7	7	7	7	7	7	7	7	7	7	7	7	7	7	7	7	7
PRESENT					7	7	7	7	7	7	7	7	7	7	7	7	7	7	7	7	7	7	7	7	7	7	7	7	7	7	7	7	7	7	7	7	7	7	7	7
ABSENT					0	0	0	0	0	0	0	0	0	0	0	0	0	0	0	0	0	0	0	0	0	0	0	0	0	0	0	0	0	0	0	0	0	0	0	0
PLACEMENT CO ORDINATOR SIGN					[Handwritten Signatures]																																			
HOD SIGN					[Handwritten Signatures]																																			
TRAINING OFFICER					[Handwritten Signatures]																																			
PRINCIPAL					[Handwritten Signatures]																																			



PRINCIPAL
K.S.R. COLLEGE OF ENGINEERING
K.S.R. KALVI NAGAR,
TIRUCHENGODE-637 215

KSR College of Engineering (Autonomous), Tiruchengode – 637 215

Training and Placement Cell

Phase – 1 Aptitude, Soft skill and Technical Training Schedule for 2023 Batch

FN	AN
Achievers Tech Talks	Interaction
Resume Building & Presentation	Essay writing & Group Discussion , Activity
SWOT Analysis & Self Introduction	Individual Activity
Permutation and Combination	Probability
Blood Relation, Syllogism	Directions, Coding and Decoding
JDK, JRE, JVM, Structure of Java class	Method overloading , Constructors
Datatypes & Operators, Identifiers	Inheritance , Polymorphism
Polymorphism	Wrapper Class
Exception Handling	String & String Builder

FN Session

9.30 am to 12.30 pm

AN Session

01.30 pm to 04.00 pm

Assessment

04.30 pm to 06.00 pm

*10.46 am – 11.00am – Break

*12.30 pm – 01.30 pm -Lunch Break

* 02.46 pm – 03.00 pm – Break

S. Gangaraj
14 March 22



PRINCIPAL
K.S.R. COLLEGE OF ENGINEERING
K.S.R. KALVI NAGAR,
TIRUCHENGODE-637 215

KSRCE/QM/5.5.3/01/TP

K.S.R. COLLEGE OF ENGINEERING (AUTONOMOUS), TIRUCHENGODE - 637215

TRAINING AND PLACEMENT CELL

STUDENT'S FEEDBACK FORM FOR TRAINING

Name of the Student : ABHISHEK M

Reg. No.: 1913002

Date: 25-03-2022

Year / Sem : III / VI

Branch : COMPUTER SCIENCE ENGINEERING

S. No.	Rate the Following	Fair 1	Good 2	Very Good 3	Excellent 4	Poor 5
Trainer Name:						
1	Content & Structure of the Training				✓	
2	Clarity of Instructions				✓	
3	Delivery of the Content				✓	
4	Method of Delivery (Use of Aids)				✓	
5	Handouts & Manuals				✓	
6	Trainer's Communication				✓	
7	Assistance from the Trainer				✓	
8	"Hands on" Practice				✓	
9	Attainment of Objective				✓	
10	Time Management				✓	
Total					✓	
How could this training be improved? (Quality/Quantity of the information presented, type of illustrations used), Mention the additional Training requirement if any.		It could be better if we are able to learn some advanced java concept.				

SHARMILA K.K

Name of the Training Programme:

Name of the Training Agency: TOP FRESHERS



M. Anand
Signature of the Student

[Signature]
PRINCIPAL
K.S.R. COLLEGE OF ENGINEERING
K.S.R. KALVI NAGAR,
TIRUCHENGODE-637 215

KSRCE/QM/5.5.3/01/TP

K.S.R. COLLEGE OF ENGINEERING (AUTONOMOUS), TIRUCHENGODE - 637215

TRAINING AND PLACEMENT CELL

STUDENT'S FEEDBACK FORM FOR TRAINING

Name of the Student : Meiyarasan P Reg. No.: 1913054 Date: 25.08.2022
 Year / Sem : IIIrd / VI Branch : Computer Science and Engineering

S. No.	Rate the Following	Fair 1	Good 2	Very Good 3	Excellent 4	Poor 5
Trainer Name: <u>SHARMILA K.K</u>					✓	
1	Content & Structure of the Training				✓✓	
2	Clarity of Instructions				✓✓	
3	Delivery of the Content				✓	
4	Method of Delivery (Use of Aids)				✓✓	
5	Handouts & Manuals		✓		✓✓	
6	Trainer's Communication			✓✓		
7	Assistance from the Trainer			✓✓		
8	"Hands on" Practice				✓	
9	Attainment of Objective				✓✓	
10	Time Management		✓		✓	
Total						
How could this training be improved? (Quality/Quantity of the information presented, type of illustrations used).		The convey of information through PPT is low.				
Mention the additional Training requirement if any.						

TECHNICAL

SHARMILA K-K
Name of the Training Programme:

TOP FRESHERS

Name of the Training Agency:



P. Meiyarasan
Signature of the Student

PRINCIPAL
K.S.R. COLLEGE OF ENGINEERING
K.S.R. KALVI NAGAR,
TIRUCHENGODE-637 215

KSRCE/QM/5.5.3/01/TP

K.S.R. COLLEGE OF ENGINEERING (AUTONOMOUS), TIRUCHENGODE - 637215

TRAINING AND PLACEMENT CELL

STUDENT'S FEEDBACK FORM FOR TRAINING

Name of the Student : K. Rithika

Reg. No.: 1913076

Date: 25-03-22

Year / Sem : III / VI

Branch : 2

S. No.	Rate the Following	Fair 1	Good 2	Very Good 3	Excellent 4	Poor 5
Trainer Name: Aravindhan					✓	
1	Content & Structure of the Training				✓	
2	Clarity of Instructions			✓		
3	Delivery of the Content				✓	
4	Method of Delivery (Use of Aids)				✓	
5	Handouts & Manuals				✓	
6	Trainer's Communication			✓		
7	Assistance from the Trainer					
8	"Hands on" Practice				✓	
9	Attainment of Objective			✓		
10	Time Management				✓	
Total						
How could this training be improved? (Quality/Quantity of the information presented, type of illustrations used).						
Mention the additional Training requirement if any.						

Name of the Training Programme: ITSS 2022

Name of the Training Agency: Top Freshers

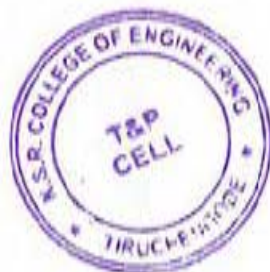

K. Rithika
Signature of the Student

PRINCIPAL
K.S.R. COLLEGE OF ENGINEERING
K.S.R. KALVI NAGAR,
TIRUCHENGODE-637 215

KSRCE/QM/5.5.3/01/TP

K.S.R. COLLEGE OF ENGINEERING (AUTONOMOUS), TIRUCHENGODE - 637215

TRAINING AND PLACEMENT CELL

STUDENT'S FEEDBACK FORM FOR TRAINING

Name of the Student : P. Vijay

Reg. No.: 1911026

Date: 25.03.2022

Year / Sem : III / VI

Branch : AUTOMOBILE ENGINEERING

S. No.	Rate the Following	Fair 1	Good 2	Very Good 3	Excellent 4	Poor 5
Trainer Name: Mr. Pradeepan.						
1	Content & Structure of the Training			✓		
2	Clarity of Instructions				✓	
3	Delivery of the Content				✓	
4	Method of Delivery (Use of Aids)				✓	
5	Handouts & Manuals				✓	
6	Trainer's Communication			✓		
7	Assistance from the Trainer		✓			
8	"Hands on" Practice		✓			
9	Attainment of Objective			✓		
10	Time Management			✓		
Total				✓		
How could this training be improved? (Quality/Quantity of the information presented, type of illustrations used).		Training was good. Only few sums solved in the period.				
Mention the additional Training requirement if any.						

ITSS-2022

Name of the Training Programme:

TOP FRESHERS

Name of the Training Agency:



Signature of the Student

PRINCIPAL
K.S.R. COLLEGE OF ENGINEERING
K.S.R. KALVINAGAR,
TIRUCHENGODE-637 215

KSRCE/QM/5.5.3/01/TP

K.S.R. COLLEGE OF ENGINEERING (AUTONOMOUS), TIRUCHENGODE - 637215

TRAINING AND PLACEMENT CELL

STUDENT'S FEEDBACK FORM FOR TRAINING

Name of the Student : Dhinushwaran . k Reg. No.: 1912007 Date: 25/03/22

Year / Sem : 3 / VIth Branch : EEE

S. No.	Rate the Following	Fair 1	Good 2	Very Good 3	Excellent 4	Poor 5
Trainer Name: <u>Thiruvenkatesan, Sindhu</u>						
1	Content & Structure of the Training			✓		
2	Clarity of Instructions				✓	
3	Delivery of the Content				✓	
4	Method of Delivery (Use of Aids)				✓	
5	Handouts & Manuals			✓		
6	Trainer's Communication				✓	
7	Assistance from the Trainer			✓		
8	"Hands on" Practice				✓	
9	Attainment of Objective				✓	
10	Time Management			✓		
Total						
How could this training be improved? (Quality/Quantity of the information presented, type of illustrations used).						
Mention the additional Training requirement if any.						

Name of the Training Programme: ITSS 2022 Name of the Training Agency: Top Freshers



K. Dinesh
Signature of the Student

PRINCIPAL
K.S.R. COLLEGE OF ENGINEERING
K.S.R. KALVI NAGAR,
TIRUCHENGODE-637 215

KSRCE/QM/5.5.3/01/TP

K.S.R. COLLEGE OF ENGINEERING (AUTONOMOUS), TIRUCHENGODE - 637215

TRAINING AND PLACEMENT CELL

STUDENT'S FEEDBACK FORM FOR TRAINING

Name of the Student : M. LOGESHWARAN

Reg. No.: 1916514

Date: 19.03.2022

Year / Sem : III / VI

Branch : MECHANICAL (B.E)

S. No.	Rate the Following	Fair 1	Good 2	Very Good 3	Excellent 4	Poor 5
Trainer Name: PRADEEPAN					✓	
1	Content & Structure of the Training				✓	
2	Clarity of Instructions				✓	
3	Delivery of the Content				✓	
4	Method of Delivery (Use of Aids)			✓		
5	Handouts & Manuals				✓	
6	Trainer's Communication			✓		
7	Assistance from the Trainer				✓	
8	"Hands on" Practice				✓	
9	Attainment of Objective				✓	
10	Time Management				✓	
Total				✓		
How could this training be improved? (Quality/Quantity of the information presented, type of illustrations used). Mention the additional Training requirement if any.						

Name of the Training Programme:

ITS3-2022

Name of the Training Agency:

TOP Freshes



Signature of the Student

M. Logeshwar
PRINCIPAL
K.S.R. COLLEGE OF ENGINEERING
K.S.R. KALVI NAGAR,
TIRUCHENGODE-637 215

KSRCE/QM/5.5.3/01/TP

K.S.R. COLLEGE OF ENGINEERING (AUTONOMOUS), TIRUCHENGODE - 637215

TRAINING AND PLACEMENT CELL

STUDENT'S FEEDBACK FORM FOR TRAINING

Name of the Student : M. Kavi

Reg. No.: 1916021

Date: 25.03.22

Year / Sem : II / VI

Branch : B.E. Mechanical

S. No.	Rate the Following	Fair 1	Good 2	Very Good 3	Excellent 4	Poor 5
Trainer Name: <u>Sindhu, thiru Venkatah</u>				✓		
1	Content & Structure of the Training			✓		
2	Clarity of Instructions		✓		✓	
3	Delivery of the Content			✓		
4	Method of Delivery (Use of Aids)			✓		
5	Handouts & Manuals		✓		✓	
6	Trainer's Communication			✓		
7	Assistance from the Trainer			✓	✓	
8	"Hands on" Practice				✓	
9	Attainment of Objective				✓	
10	Time Management				✓	
Total					✓	
How could this training be improved? (Quality/Quantity of the information presented, type of illustrations used). Mention the additional Training requirement if any.						

Name of the Training Programme:

IT&S-2022

Name of the Training Agency:

TOP Freshes.



Signature of the Student

PRINCIPAL
K.S.R. COLLEGE OF ENGINEERING
K.S.R. KALVI NAGAR,
TIRUCHENGODE-637 215

KSRCE/QM/5.5.3/01/TP

K.S.R. COLLEGE OF ENGINEERING (AUTONOMOUS), TIRUCHENGODE - 637215

TRAINING AND PLACEMENT CELL

STUDENT'S FEEDBACK FORM FOR TRAINING

Name of the Student : DSYAKAR.YReg. No.: 1914008Date: 19/3/2022Year / Sem : IIIrd / VIBranch : EEE

S. No.	Rate the Following	Fair 1	Good 2	Very Good 3	Excellent 4	Poor 5
Trainer Name: <u>Pradeepan</u>						
1	Content & Structure of the Training	✓				
2	Clarity of Instructions		✓			
3	Delivery of the Content		✓			
4	Method of Delivery (Use of Aids)			✓		
5	Handouts & Manuals			✓		
6	Trainer's Communication				✓	
7	Assistance from the Trainer			✓		
8	"Hands on" Practice		✓			
9	Attainment of Objective			✓		
10	Time Management				✓	
Total					✓	
How could this training be improved? (Quality/Quantity of the information presented, type of illustrations used).						
Mention the additional Training requirement if any.						

ITSS 2022

Name of the Training Programme:

top freshers

Name of the Training Agency:



DSYAKAR.Y
Signature of the Student

PRINCIPAL
K.S.R. COLLEGE OF ENGINEERING
K.S.R. KALVI NAGAR,
TIRUCHENGODE-637 215

KSRCE/QM/5.5.3/01/TP

K.S.R. COLLEGE OF ENGINEERING (AUTONOMOUS), TIRUCHENGODE - 637215

TRAINING AND PLACEMENT CELL

STUDENT'S FEEDBACK FORM FOR TRAINING

Name of the Student : Jagadeep .s

Reg. No.: 1915013

Date: 25/03/2022

Year / Sem : III / VI

Branch : ECE

S. No.	Rate the Following	Fair 1	Good 2	Very Good 3	Excellent 4	Poor 5
Trainer Name: Vignesh				✓		
1	Content & Structure of the Training				✓	
2	Clarity of Instructions					
3	Delivery of the Content			✓		
4	Method of Delivery (Use of Aids)			✓		
5	Handouts & Manuals				✓	
6	Trainer's Communication			✓		
7	Assistance from the Trainer			✓		
8	"Hands on" Practice				✓	
9	Attainment of Objective				✓	
10	Time Management			✓		
Total						
How could this training be improved? (Quality/Quantity of the information presented, type of illustrations used). Mention the additional Training requirement if any.		No comments.				

ITSS 2022

Name of the Training Programme:

TOP FRESHERS

Name of the Training Agency:



J. Jagadeep .s

Signature of the Student

PRINCIPAL
K.S.R. COLLEGE OF ENGINEERING
K.S.R. KALVI NAGAR,
TIRUCHENGODE-637 215

KSRCE/QM/5.5.3/01/TP

K.S.R. COLLEGE OF ENGINEERING (AUTONOMOUS), TIRUCHENGODE - 637215

TRAINING AND PLACEMENT CELL

STUDENT'S FEEDBACK FORM FOR TRAINING

Name of the Student : *A. Tanuikshi*

Reg. No.: *1915503*

Date: *19.03.2022*

Year / Sem : *III / 6th*

Branch : *B-E. ECE*

S. No.	Rate the Following	Fair 1	Good 2	Very Good 3	Excellent 4	Poor 5
Trainer Name: <i>Nandhini</i>						
1	Content & Structure of the Training	✓				
2	Clarity of Instructions		✓			
3	Delivery of the Content	✓				
4	Method of Delivery (Use of Aids)	✓				
5	Handouts & Manuals	✓				
6	Trainer's Communication	✓				
7	Assistance from the Trainer	✓				
8	"Hands on" Practice	✓				
9	Attainment of Objective		✓			
10	Time Management		✓			
Total						
How could this training be improved? (Quality/Quantity of the information presented, type of illustrations used).		<i>Reduce your speed of communication.</i>				
Mention the additional Training requirement if any.						

Name of the Training Programme: *ITSS 2022*

Name of the Training Agency: *TOP FRESHERS*



[Signature]
Signature of the Student

PRINCIPAL
K.S.R. COLLEGE OF ENGINEERING,
K.S.R. KALVI NAGAR,
TIRUCHENGODE-637 215

KSRCE/QM/5.5.3/01/TP

K.S.R. COLLEGE OF ENGINEERING (AUTONOMOUS), TIRUCHENGODE - 637215

TRAINING AND PLACEMENT CELL

STUDENT'S FEEDBACK FORM FOR TRAINING

Name of the Student : Kishore-D

Reg. No.: 1915025

Date: 19/03/2022

Year / Sem : III / VI

Branch : ECE

S. No.	Rate the Following	Fair 1	Good 2	Very Good 3	Excellent 4	Poor 5
Trainer Name: <u>Nandhini</u>						
1	Content & Structure of the Training	1				
2	Clarity of Instructions	1				1
3	Delivery of the Content		1			
4	Method of Delivery (Use of Aids)		1			
5	Handouts & Manuals		1			
6	Trainer's Communication			1		
7	Assistance from the Trainer		1			
8	"Hands on" Practice					1
9	Attainment of Objective		1			
10	Time Management		1			
Total						
How could this training be improved? (Quality/Quantity of the information presented, type of illustrations used).						
Mention the additional Training requirement if any.						

ITSL 2022

Name of the Training Programme:

Top Freshers

Name of the Training Agency:



D. Kishore
Signature of the Student

PRINCIPAL
K.S.R. COLLEGE OF ENGINEERING
K.S.R. KALVI NAGAR,
TIRUCHENGODE-637 215

KSRCE/QM/5.5.3/01/TP

K.S.R. COLLEGE OF ENGINEERING (AUTONOMOUS), TIRUCHENGODE - 637215

TRAINING AND PLACEMENT CELL

STUDENT'S FEEDBACK FORM FOR TRAINING

Name of the Student : **GOWRIHANOHARI S** Reg. No.: **1915009**

Date: **25.03.2022**

Year / Sem : **3 / 6**

Branch : **ECE**

S. No.	Rate the Following	Fair 1	Good 2	Very Good 3	Excellent 4	Poor 5
Trainer Name: VIGNESH				✓		
1	Content & Structure of the Training			✓		
2	Clarity of Instructions				✓	
3	Delivery of the Content			✓		
4	Method of Delivery (Use of Aids)				✓	
5	Handouts & Manuals			✓		
6	Trainer's Communication				✓	
7	Assistance from the Trainer					
8	"Hands on" Practice			✓		
9	Attainment of Objective		✓			
10	Time Management				✓	
Total						
How could this training be improved? (Quality/Quantity of the information presented, type of illustrations used). Mention the additional Training requirement if any.		More practice question can given in the class.				

Name of the Training Programme:

ITSS 2022

Name of the Training Agency:

TELV FRESHER



S. Gowrihanohari
Signature of the Student

PRINCIPAL
K.S.R. COLLEGE OF ENGINEERING
K.S.R. KALVI NAGAR,
TIRUCHENGODE-637215

K.S.R. COLLEGE OF ENGINEERING (AUTONOMOUS), TIRUCHENGODE - 637215

TRAINING AND PLACEMENT CELL

STUDENT'S FEEDBACK FORM FOR TRAINING

Name of the Student : M. PAVITHRA

Reg. No.: 19

Date: 19/03/2022

Year / Sem : III / V sem

Branch : B.E-CSE

S. No.	Rate the Following	Fair 1	Good 2	Very Good 3	Excellent 4	Poor 5
Trainer Name: Ms. NANDHINI						
1	Content & Structure of the Training			✓	✓	
2	Clarity of Instructions			✓		
3	Delivery of the Content				✓	
4	Method of Delivery (Use of Aids)			✓		
5	Handouts & Manuals		✓			
6	Trainer's Communication		✓			
7	Assistance from the Trainer			✓		
8	"Hands on" Practice		✓			
9	Attainment of Objective			✓		
10	Time Management			✓		
Total						
How could this training be improved? (Quality/Quantity of the information presented, type of illustrations used). Mention the additional Training requirement if any.		This training session is very good. We want more advanced questions an easy way to workout. This little thing want to improved.				

ITSS 2022

Name of the Training Programme:

Name of the Training Agency: TOP FRESHERS.



Signature of the Student

PRINCIPAL
K.S.R. COLLEGE OF ENGINEERING
K.S.R. KALVI NAGAR,
TIRUCHENGODE-637 215

K.S.R. COLLEGE OF ENGINEERING (AUTONOMOUS), TIRUCHENGODE - 637215

TRAINING AND PLACEMENT CELL

STUDENT'S FEEDBACK FORM FOR TRAINING

Name of the Student : *S. Surya.*Reg. No.: *1913095*Date: *19.03.22.*Year / Sem : *III / 6th Sem*Branch : *Computer Science Engineering.*

S. No.	Rate the Following	Fair 1	Good 2	Very Good 3	Excellent 4	Poor 5
Trainer Name: <i>Anandeevan</i>						
1	Content & Structure of the Training	<i>+</i>	<i>+</i>	<i>+</i>	<i>✓</i>	
2	Clarity of Instructions	<i>+</i>	<i>+</i>	<i>+</i>	<i>✓</i>	
3	Delivery of the Content	<i>+</i>	<i>+</i>	<i>✓</i>	<i>+</i>	
4	Method of Delivery (Use of Aids)	<i>+</i>	<i>+</i>	<i>✓</i>	<i>+</i>	
5	Handouts & Manuals	<i>+</i>	<i>+</i>	<i>✓</i>	<i>+</i>	
6	Trainer's Communication	<i>+</i>	<i>+</i>	<i>+</i>	<i>✓</i>	
7	Assistance from the Trainer	<i>+</i>	<i>+</i>	<i>+</i>	<i>✓</i>	
8	"Hands on" Practice	<i>+</i>	<i>+</i>	<i>✓</i>	<i>+</i>	
9	Attainment of Objective	<i>+</i>	<i>✓</i>	<i>+</i>	<i>+</i>	
10	Time Management	<i>+</i>	<i>✓</i>	<i>+</i>	<i>+</i>	
Total				<i>✓</i>		
How could this training be improved? (Quality/Quantity of the information presented, type of illustrations used). Mention the additional Training requirement if any.		<i>This communication and Delivery of content is very good but teaching is like maths. we cannot easily attain all sums or full mark using this method. If he overcome it will be very useful.</i>				

Name of the Training Programme:

*ITSS-2022*Name of the Training Agency: *Top freshers*

Signature of the Student

S. Surya
 PRINCIPAL
 K.S.R. COLLEGE OF ENGINEERING
 K.S.R. KALVI NAGAR,
 TIRUCHENGODE-637 215



KSRCE/QM/8.6/22/PDC

K.S.R. COLLEGE OF ENGINEERING

(Autonomous)

TIRUCHENGODE - 637 215. TAMILNADU, INDIA.

Approved by AICTE, New Delhi, Anna University, Chennai & Accredited by NBA and NAAC with 'A' Grade

Professionals Development Cell

Certificate of Participation

This is to certify that Mr./Ms..... MANOJ. G.....
 of MECHANICAL ENGINEERING..... department has participated in the
IT SPECIFIC TRAINING.....
 programme held at TRAINING AND PLACEMENT CELL - KSRCE.....
 on 14.3.22 - 26.3.22 We wish the student all success.

Date: 26.3.2022

[Signature]
Organizer

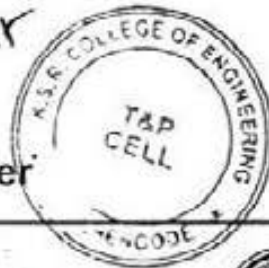

[Signature]
Co-ordinator



[Signature]
Principal
K.S.R. COLLEGE OF ENGINEERING
K.S.R. KALVI NAGAR,
TIRUCHENGODE-637 215



HIGHER EDUCATIONAL CELL





K.S.R. COLLEGE OF ENGINEERING

KSRCE/QM/8.6/22/PDC

(Autonomous)

TIRUCHENGODE - 637 215. TAMILNADU, INDIA.

Approved by AICTE, New Delhi, Anna University, Chennai & Accredited by NBA and NAAC with 'A' Grade

Professionals Development Cell

Certificate of Participation

This is to certify that Mr./Ms. DINESH . R.
 of INFORMATION TECHNOLOGY department has participated in the
IT SPECIFIC TRAINING
 programme held at TRAINING AND PLACEMENT CELL - KSRCE
 on 14.3.22 - 26.3.22. We wish the student all success.

Date: 26.03.2022

S. Ganesh
 Organizer

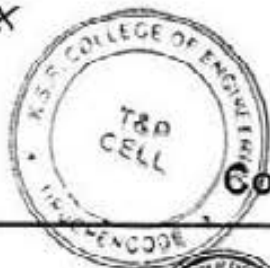

G. F. S.
 Co-ordinator



[Signature]
 Principal

[Signature]
 PRINCIPAL
 K.S.R. COLLEGE OF ENGINEERING
 K.S.R. KALVI NAGAR,
 TIRUCHENGODE - 637 215



HIGHER EDUCATIONAL CELL





K.S.R. COLLEGE OF ENGINEERING

KSRCE/QM/8.6/22/PDC

(Autonomous)

TIRUCHENGODE - 637 215.TAMILNADU, INDIA.



Approved by AICTE, New Delhi, Anna University, Chennai & Accredited by NBA and NAAC with 'A' Grade



Professionals Development Cell

Certificate of Participation

This is to certify that Mr./Ms. HARI GANESH V
 of AUTOMOBILE ENGINEERING department has participated in the
IT SPECIFIC TRAINING
 programme held at TRAINING AND PLACEMENT CELL -KSRCE
 on 14.3.22 - 26.3.22. We wish the student all success.

Date: 26.03.2022

 Organizer

 Co-ordinator

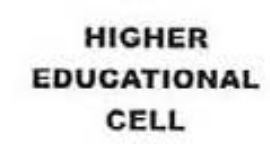

 Principal

 PRINCIPAL
 K.S.R. COLLEGE OF ENGINEERING
 K.S.R. KALVI NAGAR
 TIRUCHENGODE-637 215





KSRCE/QM/8.6/22/PDC

K.S.R. COLLEGE OF ENGINEERING

(Autonomous)

TIRUCHENGODE - 637 215. TAMILNADU, INDIA.

Approved by AICTE, New Delhi, Anna University, Chennai & Accredited by NBA and NAAC with 'A' Grade

Professionals Development Cell

Certificate of Participation

This is to certify that Mr./Ms. SHEEBA R
 of COMPUTER SCIENCE AND ENGINEERING department has participated in the
IT SPECIFIC TRAINING
 programme held at TRAINING AND PLACEMENT CELL - KSRCE
 on 14.3.22 - 26.3.22. We wish the student all success.

Date: 26.03.2022

[Signature]
 Organizer

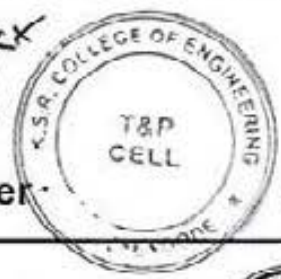

[Signature]
 Co-ordinator



[Signature]
 Principal

[Signature]
 PRINCIPAL

K.S.R. COLLEGE OF ENGINEERING
 K.S.R. KALVI NAGAR
 TIRUCHENGODE-637 215



HIGHER EDUCATIONAL CELL



2021-2022 (26)

KSRCE/IOAC/2021-2022/T&P/IC26C-64/43
K.S.R. COLLEGE OF ENGINEERING, TIRUCHENGODE - 637 215
(Autonomous)

DATE: 11.03.2022

TIME: 03.00 p.m.

CIRCULAR

CLASSIFICATION	ROUTINE	IMMEDIATE
ORIGINATOR: PRINCIPAL		CIRCULATED TO: CSE, IT & EEE HoDs

Sub.: Internal Training (Phase 1) for CSE, IT and EEE Second Year Students (2024 Batch) - Reg.

Internal Training (Phase 1) for CSE, IT and EEE Second Year Students (2024 Batch) has been organized from 14th March 2022 to 19th March 2022 (6 Days). The morning session will be conducted from 09.00 am to 12.30 pm, the afternoon session will be from 01.30 pm to 04.00 pm. So, all the regular classes will be cancelled for the training program. Concerned HoDs are requested to instruct their students to attend the whole training without fail.

Instructions to the Faculty through HoDs

1. CSE, IT & EEE Department T&P Co-ordinators are requested to monitor the attendance & discipline matters throughout the training program and update the HoDs concerned every day.

Instructions to the Students through Department T&P Co-ordinators & HoDs

1. Dress Code (Self Grooming, Formalwear with shoes)
2. Discipline
3. Punctuality

If any student not follows the above he/she may not be allowed to proceed further.

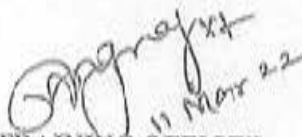
11 Mar 22
TRAINING OFFICER

PRINCIPAL

Copy to:

1. CSE, IT & EEE Department HODs for favor of information and circulation among current second year students and faculty members concerned.
2. All Training & Placement Coordinators.
3. Department Notice board.

EVIDENCE OF COMPLETION

Number of persons not received / seen: _____

Signature of Originator with date and time: _____



PRINCIPAL
K.S.R. COLLEGE OF ENGINEERING
K.S.R. KALVI NAGAR,
TIRUCHENGODE-637 215

27	2013027	GURURAJ R	CSE	P	P	P	P	P	P	P	P	P	P
28	2013028	HARIHARAN M	CSE	P	P	P	P	P	P	P	P	P	P
29	2013029	HARIPRIYA A	CSE	P	P	P	P	P	P	P	P	P	P
30	2013030	HARISH V	CSE	P	P	P	P	P	P	P	P	P	P
31	2013031	HARISH C	CSE	P	P	P	P	P	P	P	P	P	P
32	2013032	HARISH R	CSE	P	P	P	P	P	P	P	P	P	P
33	2013033	HARITHA M	CSE	P	P	P	P	P	P	P	P	P	P
34	2013034	HARSAVARTHINI N	CSE	P	P	P	P	P	P	P	A	A	
35	2013035	INDHUMATHI S K	CSE	P	P	P	P	P	P	P	P	P	P
36	2013036	JAGADEESHWARAN M	CSE	P	P	P	P	P	P	P	P	P	P
37	2013037	JANA M	CSE	P	P	P	P	P	P	P	P	P	P
38	2013038	JAYA SURYA M	CSE	P	P	P	P	P	P	P	P	P	P
39	2013039	JAYASREE M	CSE	P	P	P	P	P	P	P	P	P	P
40	2013040	JEEVITHA N	CSE	P	P	P	P	P	P	P	P	P	P
41	2013041	JEEVVANANTH S	CSE	P	P	A	A	A	A	A	A	P	P
42	2013042	JEYANDHANN A S	CSE	P	P	P	P	P	P	P	P	P	P
43	2013043	JEYPRASATH B	CSE	P	P	P	P	P	P	P	P	P	P
44	2013044	JOTHIKA MOHAN KADAM M	CSE	P	P	P	P	P	P	P	P	P	P
45	2013045	KABILAN E	CSE	P	P	P	P	P	P	P	P	P	P
46	2013046	KALAIYARASAN C	CSE	P	P	A	A	P	P	P	P	P	P
47	2013047	KARTHIGA S	CSE	P	P	P	P	P	P	P	P	P	P
48	2013048	KAVIN KUMAR M	CSE	P	P	P	P	P	P	P	P	P	P
49	2013049	KAVIN PRASANTH R	CSE	P	P	A	A	P	P	P	P	P	P
50	2013050	KAVIN RAJA M	CSE	P	P	P	P	P	P	P	P	P	P
51	2013051	KAVIYA S	CSE	P	P	P	P	P	P	P	P	P	P
52	2013052	KAVIYA S	CSE	P	P	P	P	P	P	P	P	P	P
53	2013053	KEERTHI ALAGIRI P	CSE	P	P	P	P	P	P	P	P	P	P
54	2013054	KISHAN R	CSE	P	P	P	P	P	P	P	P	P	P
55	2013055	KISHORANANDH R S	CSE	P	P	P	P	P	P	P	P	P	P
56	2013056	LINGESH PRABHU T	CSE	P	P	P	P	P	P	P	P	P	P
57	2013057	LOGESHWARAN N	CSE	P	P	P	P	P	P	A	A	A	A

58	2013058	MADHUMITHA N	CSE	P	P	P	P	P	P	P	P	P	P	
59	2013059	MAHENDRAN M	CSE	P	P	P	P	P	P	A	A	A	A	
60	2013060	MANIKANDAN L	CSE	P	P	P	P	P	P	P	P	P	P	
61	2013061	MEENAKSHI S	CSE	P	P	P	P	P	P	P	P	P	P	
62	2013062	MIDHUN M	CSE	P	P	P	P	P	P	P	P	P	P	
63	2013063	MOHAMED KALIFA S	CSE	P	P	P	P	P	P	P	P	P	P	
64	2013501	ARUNKUMAR K	CSE	P	P	P	P	P	P	P	P	P	P	
65	2013502	BHARATHI T	CSE	P	P	P	P	P	P	P	P	P	P	
66	2013503	DHARUN L	CSE	P	P	P	P	P	P	P	P	P	P	
67	2013504	GUNALAN R	CSE	P	P	P	P	P	P	P	P	P	P	
68	2013505	INDRISH S	CSE	P	P	P	P	P	P	P	P	P	P	
69	2013506	JEEVA M	CSE	P	P	P	P	P	P	P	P	P	P	
TOTAL				69	69	69	69	69	69	69	69	69	69	69
PRESENT				69	69	65	65	67	67	65	65	63	63	63
ABSENT				-	-	4	4	2	2	4	4	6	6	6
PLACEMENT CO ORDINATOR SIGN				<i>sl</i>	<i>sl</i>	<i>sl</i>	<i>sl</i>	<i>sl</i>	<i>sl</i>	<i>sl</i>	<i>sl</i>	<i>sl</i>	<i>sl</i>	<i>sl</i>
HOD SIGN				<i>d</i>	<i>d</i>	<i>d</i>	<i>d</i>	<i>d</i>	<i>d</i>	<i>d</i>	<i>d</i>	<i>d</i>	<i>d</i>	<i>d</i>
TRAINING OFFICER				<i>sl</i>	<i>sl</i>	<i>sl</i>	<i>sl</i>	<i>sl</i>	<i>sl</i>	<i>sl</i>	<i>sl</i>	<i>sl</i>	<i>sl</i>	<i>sl</i>
PRINCIPAL				<i>N</i>	<i>N</i>	<i>N</i>	<i>N</i>	<i>N</i>	<i>N</i>	<i>N</i>	<i>N</i>	<i>N</i>	<i>N</i>	<i>N</i>



PRINCIPAL
K.S.R. COLLEGE OF ENGINEERING
K.S.R. KALVI NAGAR,
TIRUCHENGODE-637 215

K.S.R. COLLEGE OF ENGINEERING (AUTONOMOUS), TIRUCHENGODE - 637 215

TRAINING AND PLACEMENT

IT SECOND YEAR (INTERNAL) TRAINING ATTENDANCE DETAILS -2024 BATCH

S. No	REG NO	NAME	DATE	14.03.2022		15.03.2022		16.03.2022		17.03.2022		18.03.2022	
			BRANCH	FN	AN	FN	AN	FN	AN	FN	AN	FN	AN
1	2021001	ABISHEK.U	IT	P	P	P	P	P	P	P	P	P	P
2	2021002	ABISHEK.R.S	IT	P	P	P	P	P	P	P	P	P	P
3	2021003	BALAJI.M	IT	P	P	P	P	P	P	P	P	P	P
4	2021004	BATSHA. T	IT	P	P	P	P	P	P	P	P	P	P
5	2021005	BHARATHI.P	IT	P	P	P	P	P	P	P	P	P	P
6	2021006	BHASKARAPRASATH.S.K	IT	P	P	P	P	P	P	P	P	P	P
7	2021007	BHUVANESH.G	IT	P	P	P	P	P	P	P	P	P	P
8	2021008	DHANUSHYA.K	IT	P	P	P	P	P	P	P	P	P	P
9	2021009	DIVYA.K	IT	P	P	P	P	P	P	P	P	P	P
10	2021011	FARITHA BANU M	IT	P	P	P	P	P	P	P	P	P	P
11	2021012	GIRIJA.V	IT	P	P	P	P	P	P	P	P	P	P
12	2021013	GNANAPRAKASH.J	IT	A	A	P	P	P	P	P	P	P	P
13	2021014	GOBIKA.C	IT	P	P	P	P	P	P	P	P	P	P
14	2021015	GOKUL.R	IT	P	P	P	P	P	P	P	P	P	P
15	2021016	GOKUL.V	IT	P	P	P	P	A	A	A	A	A	A
16	2021017	GOPI.M	IT	A	A	A	A	P	P	P	P	P	P
17	2021018	GOPINATH.N	IT	P	P	P	P	P	P	P	P	P	P
18	2021019	HARIPRASATH.S	IT	P	P	P	P	A	A	P	P	P	P
19	2021020	HARIPRIYA.G	IT	P	P	P	P	P	P	P	P	P	P
20	2021021	KALPANA.V	IT	P	P	P	P	P	P	P	P	P	P
21	2021022	KANISHKA.V	IT	P	P	P	P	P	P	P	P	P	P
22	2021023	KAVIN.S	IT	P	P	P	P	P	P	P	P	P	P
23	2021024	KAVIN KUMAR.R	IT	A	A	P	P	P	P	P	P	P	P
24	2021025	KISHORE.B	IT	P	P	P	P	P	P	P	P	P	P
25	2021026	LALITH KUMAR.R	IT	A	A	A	A	A	A	P	P	P	P
26	2021027	LOGA MOORTHY.S	IT	P	P	P	P	P	P	P	P	P	P

 PRINCIPAL
 K.S.R. COLLEGE OF ENGINEERING
 K.S.R. KALVI NAGAR,
 TIRUCHENGODE-637 215

58	2021060	YUVASREE.S	IT	P	P	P	P	P	P	P	P	P	P
59	20LIT001	ESWAR CHANDAR. P	IT	A	A	A	A	P	P	P	P	P	P
60	20LIT002	GOWTHAMAN .S	IT	P	P	P	P	A	A	P	P	P	P
61	20LIT003	JEENATH .N	IT	A	A	A	A	A	A	A	A	A	A
62	20LIT004	PRAKASH .K	IT	P	P	P	P	P	P	P	P	P	P
63	20LIT005	SIVABALAN. G	IT	P	P	P	P	P	P	P	P	A	A
64	20LIT006	VIDHYASRI. G	IT	P	P	P	P	P	P	P	P	P	P
TOTAL				64	64	64	64	64	64	64	64	64	64
PRESENT				58	58	60	60	59	59	62	62	61	61
ABSENT				6	6	4	4	5	5	2	2	3	3
PLACEMENT CO ORDINATOR SIGN													
HOD SIGN													
TRAINING OFFICER													
PRINCIPAL													



 PRINCIPAL
 K.S.R. COLLEGE OF ENGINEERING
 K.S.R. KALVI NAGAR,
 TIRUCHENGODE-637 215

K.S.R. COLLEGE OF ENGINEERING (AUTONOMOUS), TIRUCHENGODE - 637 215

TRAINING AND PLACEMENT

EEE SECONDER YEAR (INTERNAL) TRAINING ATTENDANCE DETAILS -2024 BATCH

S. No	REG NO	NAME	DATE	14.03.2022		15.03.2022		16.03.2022		17.03.2022		18.03.2022	
			BRANCH	FN	AN	FN	AN	FN	AN	FN	AN	FN	AN
1	2014001	AJAYKUMAR M	EEE	P	P	P	P	P	P	P	P	P	P
2	2014002	AKSHAYAA S	EEE	P	P	P	P	P	P	P	P	P	P
3	2014003	ARAVINDH R	EEE	P	P	P	P	P	P	P	P	P	P
4	2014004	ASHOK KUMAR S	EEE	P	P	P	P	P	P	P	P	P	P
5	2014005	BALASURYA J	EEE	P	P	A	A	P	P	P	P	P	P
6	2014006	DHAKSHAYANE THARENE MKS	EEE	P	P	P	P	P	P	P	P	P	P
7	2014007	DHAMODHARAN M	EEE	P	P	P	P	P	P	P	P	P	P
8	2014008	DHANISH M	EEE	P	P	P	P	P	P	P	P	P	P
9	2014009	DHANUSH R	EEE	P	P	P	P	A	A	A	A	P	P
10	2014010	DINESH M	EEE	P	P	P	P	P	P	P	P	P	P
11	2014011	DIVAGAR C	EEE	P	P	P	P	P	P	P	P	P	P
12	2014012	ESWARARUNPRAKASH J K	EEE	P	P	P	P	P	P	P	P	P	P
13	2014013	KABISH C	EEE	P	P	A	A	P	P	P	P	P	P
14	2014014	KARTHIK G	EEE	A	A	P	P	P	P	P	P	P	P
15	2014015	KAVIYA R	EEE	P	P	P	P	P	P	P	P	P	P
16	2014016	KRISHNAMOORTHY S	EEE	P	P	A	A	P	P	P	P	P	P
17	2014017	MAHESHWARAN C	EEE	P	P	A	A	P	P	P	P	P	P
18	2014018	MEGANATHAN C	EEE	A	A	A	A	P	P	P	P	P	P
19	2014019	MOHANAKUMAR N S	EEE	P	P	P	P	P	P	P	P	P	P
20	2014020	MONITHKUMAR B	EEE	P	P	P	P	P	P	P	P	P	P
21	2014021	NAVANEETHA KRISHNAN S	EEE	A	A	P	P	P	P	P	P	P	P
22	2014022	NAVEEN T	EEE	P	P	P	P	P	P	P	P	P	P
23	2014023	NAVEEN KUMAR V	EEE	A	A	P	P	P	P	P	P	P	P
24	2014024	NIVIYA R	EEE	P	P	P	P	P	P	P	P	P	P
25	2014025	PERIYANARAYANAN S	EEE	P	P	P	P	P	P	P	P	P	P
26	2014026	PREETHI C	EEE	P	P	P	P	P	P	P	P	P	P
27	2014027	RAGAVAN S	EEE	P	P	P	P	P	P	P	P	P	P

 PRINCIPAL
 K.S.R. COLLEGE OF ENGINEERING
 K.S.R. KALVI NAGAR,
 TIRUCHENGODE-637 215

61	2014518	SIBI CHAKRAVARTHI C	EEE	P	P	P	P	P	P	P	P	P	P
62	2014519	SUDHAKARAN S	EEE	P	P	P	P	P	P	P	P	P	P
63	2014520	THARUN B	EEE	P	P	P	P	P	P	P	P	P	P
64	2014521	VISHVANATH B	EEE	P	P	P	P	P	P	P	P	P	P
65	2014522	VISHVARAJ L S	EEE	P	P	P	P	P	P	P	P	P	P
66	2014523	YUVARAJ S	EEE	A	A	P	P	P	P	P	P	P	P
TOTAL				66	66	66	66	66	66	66	66	66	66
PRESENT				56	56	57	57	63	63	63	63	64	64
ABSENT				10	10	09	09	03	03	03	03	02	02
PLACEMENT CO ORDINATOR SIGN				<i>[Signature]</i>	<i>[Signature]</i>	<i>[Signature]</i>	<i>[Signature]</i>	<i>[Signature]</i>	<i>[Signature]</i>	<i>[Signature]</i>	<i>[Signature]</i>	<i>[Signature]</i>	<i>[Signature]</i>
HOD SIGN				<i>[Signature]</i>	<i>[Signature]</i>	<i>[Signature]</i>	<i>[Signature]</i>	<i>[Signature]</i>	<i>[Signature]</i>	<i>[Signature]</i>	<i>[Signature]</i>	<i>[Signature]</i>	<i>[Signature]</i>
TRAINING OFFICER				<i>[Signature]</i>	<i>[Signature]</i>	<i>[Signature]</i>	<i>[Signature]</i>	<i>[Signature]</i>	<i>[Signature]</i>	<i>[Signature]</i>	<i>[Signature]</i>	<i>[Signature]</i>	<i>[Signature]</i>
PRINCIPAL				<i>[Signature]</i>	<i>[Signature]</i>	<i>[Signature]</i>	<i>[Signature]</i>	<i>[Signature]</i>	<i>[Signature]</i>	<i>[Signature]</i>	<i>[Signature]</i>	<i>[Signature]</i>	<i>[Signature]</i>



[Signature]
 PRINCIPAL
 K.S.R. COLLEGE OF ENGINEERING
 K.S.R. KALVI NAGAR,
 TIRUCHENGODE-637 215

K.S.R. COLLEGE OF ENGINEERING (AUTONOMOUS), TIRUCHENGODE - 637 215

TRAINING AND PLACEMENT

CSE SECOND YEAR (INTERNAL) TRAINING ATTENDANCE DETAILS -2024 BATCH

S. No	REG NO	NAME	DATE	14.03.2022		15.03.2022		16.03.2022		17.03.2022		18.03.2022	
			BRANCH	FN	AN	FN	AN	FN	AN	FN	AN	FN	AN
1	2013064	MONISH S K	CSE	A	A	A	A	P	P	P	P	P	P
2	2013065	NARMATHA V	CSE	P	P	P	P	P	P	P	P	P	P
3	2013066	NAVEEN M	CSE	P	P	P	P	P	P	P	P	P	P
4	2013067	NAVEEN N K	CSE	P	P	P	P	P	P	P	P	P	P
5	2013068	NAVEEN KUMAR A T	CSE	P	P	P	P	P	P	P	P	P	P
6	2013069	NIRANJAN K	CSE	A	A	P	P	P	P	P	P	P	P
7	2013070	NISHANTH K	CSE	P	P	P	P	P	P	P	P	P	P
8	2013071	NITHINKUMAR S R	CSE	P	P	P	P	P	P	P	P	P	P
9	2013072	PASUPATHI P	CSE	P	P	P	P	A	A	A	A	P	P
10	2013073	PONJEEVA J	CSE	P	P	P	P	P	P	P	P	P	P
11	2013074	PONKARTHIKEYAN B	CSE	P	P	P	P	P	P	P	P	P	P
12	2013075	PRASANTH M	CSE	P	P	P	P	P	P	P	P	P	P
13	2013076	PRASANTH S	CSE	P	P	P	P	P	P	P	P	P	P
14	2013077	PRATHISHA T	CSE	P	P	P	P	P	P	P	P	P	P
15	2013079	PREETHIKA M	CSE	P	P	P	P	P	P	P	P	P	P
16	2013080	RAJASURYA R	CSE	P	P	P	P	P	P	P	P	P	P
17	2013081	RAKESHKANNAN M	CSE	P	P	P	P	P	P	P	P	P	P
18	2013082	RAMASUBRAMANIYAN M	CSE	P	P	P	P	P	P	P	P	P	P
19	2013083	RANJITH KUMAR A	CSE	P	P	P	P	P	P	P	P	P	P
20	2013084	RAVIPRAVIN M	CSE	P	P	P	P	P	P	P	P	A	A
21	2013085	ROOBADHARSHINI M	CSE	P	P	P	P	P	P	P	P	P	P
22	2013086	SABARINATHAN L	CSE	P	P	P	P	A	A	P	P	P	P
23	2013087	SABARINATHAN M	CSE	P	P	P	P	P	P	P	P	A	A
24	2013088	SAKTHIVEL T	CSE	P	P	P	P	P	P	P	P	P	P
25	2013089	SANJAY M	CSE	P	P	P	P	P	P	P	P	P	P
26	2013090	SANJAYKUMAR G	CSE	P	P	P	P	P	P	P	P	P	P



PRINCIPAL
K.S.R. COLLEGE OF ENGINEERING
K.S.R. KALVI NA
TIRUCHENGODE

58	2013122	VIJAY D	CSE	P	P	P	P	P	P	P	P	P	P
59	2013123	VINOTH R	CSE	P	P	P	P	P	P	P	P	P	P
60	2013124	VISHWARAJ S	CSE	P	P	P	P	P	P	P	P	P	P
61	2013125	YASHWANTHINI A	CSE	P	P	P	P	P	P	P	P	P	P
62	2013126	YUGA PRIYAN S	CSE	P	P	P	P	P	P	P	P	P	P
63	2013507	KAVIYA S	CSE	P	P	P	P	P	P	P	P	P	P
64	2013508	MYILSAMY S	CSE	P	P	P	P	P	P	P	P	P	P
65	2013509	NAVEEN S	CSE	P	P	P	P	P	P	P	P	P	P
66	2013510	SUBASH T	CSE	A	A	P	P	A	A	P	P	P	P
67	2013511	SYED IBRAHIM T	CSE	P	P	P	P	P	P	P	P	P	P
68	2013512	VANMATHI K	CSE	P	P	P	P	P	P	P	P	P	P
TOTAL				68	68	68	68	68	68	68	68	68	68
PRESENT				60	60	66	66	65	62	66	66	63	63
ABSENT				8	8	2	2	4	4	2	2	5	5
PLACEMENT CO ORDINATOR SIGN				sh	sh	sh	sh	sh	sh	sh	sh	sh	sh
HOD SIGN				o	o	o	o	o	o	o	o	o	o
TRAINING OFFICER				sh	sh	sh	sh	sh	sh	sh	sh	sh	sh
PRINCIPAL				N	N	N	N	N	N	N	N	N	N



 PRINCIPAL
 K.S.R. COLLEGE OF ENGINEERING
 K.S.R. KALVI NAGAR,
 TIRUCHENGODE-637 215

KSR College of Engineering (Autonomous), Tiruchengode – 637 215

Training and Placement Cell

Phase – 1 Technical Training Schedule for 2023 Batch

FN	AN
JDK , JRE , JVM , Structure of Java class	Access and non Access Specifiers
Data types & Operators, Identifiers	Method overloading
Arrays and Array List	Constructors
Inheritance and Interfaces	Polymorphism
Wrapper Class	String & String Builder
Exception Handling	Multi Threading
Data base Connectivity	Logical Building

FN Session

9.30 am to 12.30 pm

AN Session

01.30 pm to 04.00 pm

Assessment

04.30 pm to 06.00 pm

*10.46 am – 11.00am - Break

*12.30 pm – 01.30 pm -Lunch Break

* 02.46 pm – 03.00 pm – Break

S. Aranganjath
14 Mar 22



PRINCIPAL
K.S.R. COLLEGE OF ENGINEERING
K.S.R. KALVI NAGAR,
TIRUCHENGODE-637 215



KSRCE/QM/8.6/22/PDC

K.S.R. COLLEGE OF ENGINEERING

(Autonomous)

TIRUCHENGODE - 637 215 TAMILNADU, INDIA

Approved by AICTE, New Delhi, Anna University, Chennai & Accredited by NBA and NAAC with 'A' Grade

Professionals Development Cell

Certificate of Participation

This is to certify that Mr./Ms. VIGNESH . C
 of INFORMATION TECHNOLOGY department has participated in the
TECHNICAL TRAINING
 programme held at TRAINING AND PLACEMENT CELL - KSRCE
 on 14.3.22 - 19.3.22. We wish the student all success.

Date: 19.3.22

S. Ganesh
Organizer



G. S.
Co-ordinator



[Signature]
Principal

PRINCIPAL
K.S.R. COLLEGE OF EN
K.S.R. KALVI NA
TIRUCHENGODE-6



HIGHER
EDUCATIONAL
CELL



ENGINEERING
R,
215



KSRCE/QM/8.6/22/PDC

K.S.R. COLLEGE OF ENGINEERING

(Autonomous)







TIRUCHENGODE - 637 215. TAMILNADU, INDIA.

Approved by AICTE, New Delhi, Anna University, Chennai & Accredited by NBA and NAAC with 'A' Grade

Professionals Development Cell

Certificate of Participation

This is to certify that Mr./Ms..... GIOKOL V......
 of..... INFORMATION TECHNOLOGY..... department has participated in the
 TECHNICAL TRAINING.....
 programme held at TRAINING AND PLACEMENT CELL - KSRCE.....
 on 14.3.22 - 19.3.22..... We wish the student all success.

Date: 19.3.2022  Organizer  Co-ordinator   Principal   PRINCIPAL
 K.S.R. COLLEGE OF ENGINEERING
 K.S.R. KALVI NAGAR
 TIRUCHENGODE-637 215



HIGHER EDUCATIONAL CELL





KSRCE/QM/8.6/22/PDC

K.S.R. COLLEGE OF ENGINEERING

(Autonomous)

TIRUCHENGODE - 637 215.TAMILNADU, INDIA.

Approved by AICTE, New Delhi, Anna University, Chennai & Accredited by NBA and NAAC with 'A' Grade

Professionals Development Cell

Certificate of Participation

This is to certify that Mr./Ms. BHARATH S.
 of COMPUTER SCIENCE AND ENGINEERING department has participated in the
TECHNICAL TRAINING
 programme held at TRAINING AND PLACEMENT CELL - KSRCE
 on 14.3.22 - 19.3.22. We wish the student all success.

Date: 19.03.2022

S. Srinivasan
Organizer

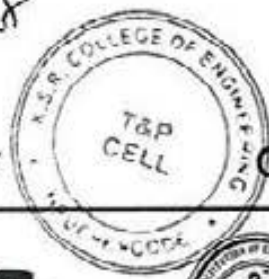

G. Srinivasan
Co-ordinator



[Signature]
Principal

PRINCIPAL
K.S.R. COLLEGE OF ENGINEERING
K.S.R. KALVI NAGAR
TIRUCHENGODE-637 215



HIGHER EDUCATIONAL CELL





KSRCE/QM/8.6/22/PDC

K.S.R. COLLEGE OF ENGINEERING

(Autonomous)

TIRUCHENGODE - 637 215. TAMILNADU, INDIA.

Approved by AICTE, New Delhi, Anna University, Chennai & Accredited by NBA and NAAC with 'A' Grade

Professionals Development Cell

Certificate of Participation

This is to certify that ~~Mr./Ms.~~..... KAVIYA..... R......
of ELECTRICAL AND ELECTRONICS ENGINEERING department has participated in the
..... TECHNICAL TRAINING.....
programme held at TRAINING AND PLACEMENT CELL - KSRCE.....
on 14.3.22 - 19.3.22. We wish the student all success.

Date: 19.03.22

S. Manjath
Organizer



G. S. S.
Co-ordinator



[Signature]
Principal

PRINCIPAL
K.S.R. COLLEGE OF ENGINEERING
K.S.R. KALVI NAGAR
TIRUCHENGODE-637 215



HIGHER EDUCATIONAL CELL



ERIN
15

2021-2022

27

KSRCE/IQAC/2021-2022/T&P/IC26C-64/48

K.S.R. COLLEGE OF ENGINEERING, TIRUCHENGODE - 637 215
(Autonomous)

DATE: 01.04.2022

TIME: 03.00 p.m.

CIRCULAR

CLASSIFICATION	ROUTINE	IMMEDIATE
ORIGINATOR: PRINCIPAL		CIRCULATED TO: All UG & MCA HoDs

Sub.: IT Specific Training for all UG Pre Final Year and MCA Students (2023 Batch) - Reg.

External Training for all UG Pre Final Year & MCA Students (2023 Batch) has been organized from 06th April 2022 to 20th April 2022 (13 Days). The training will be conducted from 09.00 am to 10.00 pm and session details will be shared shortly. All the regular classes will be cancelled for the training program. We advise the students to stay in hostel for better learning and practice. Concerned HoDs are requested to instruct their students to attend the whole training without fail.

Instructions to the Faculty through HoDs

1. All the Department T&P Co-ordinators are requested to monitor the attendance & discipline matters throughout the training program and inform to the concerned HoDs every day.

Instructions to the Students through Department T&P Co-ordinators & HoDs

1. Dress Code (Self Grooming, Formalwear with shoes)
2. Discipline
3. Punctuality

If any student fails to follow the above, he or she may not be allowed to proceed further in the process.

S. G. [Signature]
APR 22
TRAINING OFFICER

[Signature]
PRINCIPAL

Copy to:

1. All UG HODS for favor of information and circulation among current pre final year students and faculty members concerned.
2. All Training & Placement Coordinators.
3. Department Notice board.

EVIDENCE OF COMPLETION

Number of persons not received / seen: _____

Signature of Originator with date and time: _____



[Signature]

PRINCIPAL
K.S.R. COLLEGE OF ENGINEERING
K.S.R. KALVI NAGAR,
TIRUCHENGODE-637 215

KSR College of Engineering (Autonomous), Tiruchengode – 637 215

Training and Placement Cell

Phase – 1 Aptitude, Soft skill and Technical Training Schedule for 2023 Batch

FN	AN
Achievers Tech Talks	Interaction
Resume Building & Presentation	Essay writing & Group Discussion , Activity
SWOT Analysis & Self Introduction	Individual Activity
Permutation and Combination	Probability
Blood Relation, Syllogism	Directions, Coding and Decoding
JDK, JRE, JVM, Structure of Java class	Method overloading , Constructors
Datatypes & Operators, Identifiers	Inheritance , Polymorphism
Polymorphism	Wrapper Class
Exception Handling	String & String Builder

FN Session

9.30 am to 12.30 pm

AN Session

01.30 pm to 04.00 pm

Assessment

04.30 pm to 06.00 pm

*10.46 am – 11.00am - Break

*12.30 pm – 01.30 pm -Lunch Break

* 02.46 pm – 03.00 pm – Break



PRINCIPAL
K.S.R. COLLEGE OF ENGINEERING
K.S.R. KALVI NAGAR,
TIRUCHENGODE-637 215

K.S.R. COLLEGE OF ENGINEERING (AUTONOMOUS), TIRUCHENGODE - 637 215

TRAINING AND PLACEMENT

KSRCE - IT Service Specific Training 2022 for 2023 Batch (06.04.2022 to 20.04.2022)

S.No	Reg No	Name	Branch	06.04.2022				07.04.2022				08.04.2022				09.04.2022				11.04.2022				12.04.2022				13.04.2022				14.04.2022			
				FN	AN	EVE	NIT	FN	AN	EVE	NIT	FN	AN	EVE	NIT	FN	AN	EVE	NIT	FN	AN	EVE	NIT	FN	AN	EVE	NIT	FN	AN	EVE	NIT	FN	AN	EVE	NIT
1	1911001	BALACHANDAR A	AUTO	/	/	/	/	/	/	/	/	/	/	/	/	OD	OD	OD	OD	/	/	/	/	/	/	/	/	/	/	/	/	/	/	/	/
2	1911006	GOKULPRANESH C	AUTO	/	/	/	/	/	/	/	/	/	/	/	/	/	/	/	/	/	/	/	/	/	/	/	/	/	/	/	/	/	/	/	/
3	1911008	HARIGANESH V	AUTO	/	/	/	/	/	/	/	/	/	/	/	/	/	/	/	/	/	/	/	/	/	/	/	/	/	/	/	/	/	/	/	/
4	1911015	NITHYASHREE R	AUTO	/	/	/	/	/	/	/	/	/	/	/	/	OD	OD	OD	OD	/	/	/	/	/	/	/	/	/	/	/	/	/	/	/	/
5	1911023	SUGUMAR D	AUTO	/	/	/	/	/	/	/	/	/	/	/	/	/	/	/	/	/	/	/	/	/	/	/	/	/	/	/	/	/	/	/	/
6	1911024	SUJEETH N	AUTO	/	/	/	/	/	/	/	/	/	/	/	/	/	/	/	/	/	/	/	/	/	/	/	/	/	/	/	/	/	/	/	/
7	1911026	VIJAY P	AUTO	/	/	/	/	/	/	/	/	/	/	/	/	OD	OD	OD	OD	/	/	/	/	/	/	/	/	/	/	/	/	/	/	/	/
TOTAL				7	7	7	7	7	7	7	7	7	7	7	7	7	7	7	7	7	7	7	7	7	7	7	7	7	7	7	7	7	7	7	7
PRESENT				7	7	7	7	7	7	7	7	7	7	7	7	7	7	7	7	7	7	7	7	7	7	7	7	7	7	7	7	7	7	7	7
ABSENT				-	-	-	-	-	-	-	-	-	-	-	-	OD	OD	OD	OD	-	-	-	-	-	-	-	-	-	-	-	-	-	-	-	-
PLACEMENT CO ORDINATOR SIGN				<i>[Signature]</i>	<i>[Signature]</i>	<i>[Signature]</i>	<i>[Signature]</i>	<i>[Signature]</i>	<i>[Signature]</i>	<i>[Signature]</i>	<i>[Signature]</i>	<i>[Signature]</i>	<i>[Signature]</i>	<i>[Signature]</i>	<i>[Signature]</i>	<i>[Signature]</i>	<i>[Signature]</i>	<i>[Signature]</i>	<i>[Signature]</i>	<i>[Signature]</i>	<i>[Signature]</i>	<i>[Signature]</i>	<i>[Signature]</i>	<i>[Signature]</i>	<i>[Signature]</i>	<i>[Signature]</i>	<i>[Signature]</i>	<i>[Signature]</i>	<i>[Signature]</i>	<i>[Signature]</i>	<i>[Signature]</i>	<i>[Signature]</i>	<i>[Signature]</i>	<i>[Signature]</i>	
HOD SIGN				<i>[Signature]</i>	<i>[Signature]</i>	<i>[Signature]</i>	<i>[Signature]</i>	<i>[Signature]</i>	<i>[Signature]</i>	<i>[Signature]</i>	<i>[Signature]</i>	<i>[Signature]</i>	<i>[Signature]</i>	<i>[Signature]</i>	<i>[Signature]</i>	<i>[Signature]</i>	<i>[Signature]</i>	<i>[Signature]</i>	<i>[Signature]</i>	<i>[Signature]</i>	<i>[Signature]</i>	<i>[Signature]</i>	<i>[Signature]</i>	<i>[Signature]</i>	<i>[Signature]</i>	<i>[Signature]</i>	<i>[Signature]</i>	<i>[Signature]</i>	<i>[Signature]</i>	<i>[Signature]</i>	<i>[Signature]</i>	<i>[Signature]</i>	<i>[Signature]</i>	<i>[Signature]</i>	
TRAINING OFFICER				<i>[Signature]</i>	<i>[Signature]</i>	<i>[Signature]</i>	<i>[Signature]</i>	<i>[Signature]</i>	<i>[Signature]</i>	<i>[Signature]</i>	<i>[Signature]</i>	<i>[Signature]</i>	<i>[Signature]</i>	<i>[Signature]</i>	<i>[Signature]</i>	<i>[Signature]</i>	<i>[Signature]</i>	<i>[Signature]</i>	<i>[Signature]</i>	<i>[Signature]</i>	<i>[Signature]</i>	<i>[Signature]</i>	<i>[Signature]</i>	<i>[Signature]</i>	<i>[Signature]</i>	<i>[Signature]</i>	<i>[Signature]</i>	<i>[Signature]</i>	<i>[Signature]</i>	<i>[Signature]</i>	<i>[Signature]</i>	<i>[Signature]</i>	<i>[Signature]</i>	<i>[Signature]</i>	
PRINCIPAL				<i>[Signature]</i>	<i>[Signature]</i>	<i>[Signature]</i>	<i>[Signature]</i>	<i>[Signature]</i>	<i>[Signature]</i>	<i>[Signature]</i>	<i>[Signature]</i>	<i>[Signature]</i>	<i>[Signature]</i>	<i>[Signature]</i>	<i>[Signature]</i>	<i>[Signature]</i>	<i>[Signature]</i>	<i>[Signature]</i>	<i>[Signature]</i>	<i>[Signature]</i>	<i>[Signature]</i>	<i>[Signature]</i>	<i>[Signature]</i>	<i>[Signature]</i>	<i>[Signature]</i>	<i>[Signature]</i>	<i>[Signature]</i>	<i>[Signature]</i>	<i>[Signature]</i>	<i>[Signature]</i>	<i>[Signature]</i>	<i>[Signature]</i>	<i>[Signature]</i>	<i>[Signature]</i>	



PRINCIPAL
K.S.R. COLLEGE OF ENGINEERING
K.S.R. KALVI NAGAR,
TIRUCHENGODE-637 215

K.S.R. COLLEGE OF ENGINEERING (AUTONOMOUS), TIRUCHENGODE - 637 215

TRAINING AND PLACEMENT

KSRCE - IT Service Specific Training 2022 for 2023 Batch (06.04.2022 to 18.04.2022)

S.No	Reg No	Name	Branch	14.04.2022				15.04.2022				16.04.2022				17.04.2022				18.04.2022			
				FN	AN	EVE	NGT	FN	AN	EVE	NGT	FN	AN	EVE	NGT	FN	AN	EVE	NGT	FN	AN	EVE	NGT
1	1911001	BALACHANDAR A	AUTO	/	/	/	/	/	/	/	/	/	/	/	/	/	/	/	/	/	/	/	/
2	1911006	GOKULPRANESH C	AUTO	/	/	/	/	/	/	/	/	/	/	/	/	/	/	/	/	/	/	/	/
3	1911008	HARIGANESH V	AUTO	/	/	/	/	/	/	/	/	/	/	/	/	/	/	/	/	/	/	/	/
4	1911015	NITHYASHREE R	AUTO	/	/	/	/	/	/	/	/	/	/	/	/	/	/	/	/	/	/	/	/
5	1911023	SUGUMAR D	AUTO	/	/	/	/	/	/	/	/	/	/	/	/	/	/	/	/	/	/	/	/
6	1911024	SUJEETH N	AUTO	/	/	/	/	/	/	/	/	/	/	/	/	/	/	/	/	/	/	/	/
7	1911026	VIJAY P	AUTO	/	/	/	/	/	/	/	/	/	/	/	/	/	/	/	/	/	/	/	/
TOTAL				7	7	7	7	7	7	7	7	7	7	7	7	7	7	7	7	7	7	7	7
PRESENT				7	7	7	7	7	7	7	7	7	7	7	7	7	7	7	7	7	7	7	7
ABSENT				-	-	-	-	-	-	-	-	-	-	-	-	-	-	-	-	-	-	-	-
PLACEMENT CO ORDINATOR SIGN				<i>[Signature]</i>	<i>[Signature]</i>	<i>[Signature]</i>	<i>[Signature]</i>	<i>[Signature]</i>	<i>[Signature]</i>	<i>[Signature]</i>	<i>[Signature]</i>	<i>[Signature]</i>	<i>[Signature]</i>	<i>[Signature]</i>	<i>[Signature]</i>	<i>[Signature]</i>	<i>[Signature]</i>	<i>[Signature]</i>	<i>[Signature]</i>	<i>[Signature]</i>	<i>[Signature]</i>	<i>[Signature]</i>	<i>[Signature]</i>
HOD SIGN				<i>[Signature]</i>				<i>[Signature]</i>				<i>[Signature]</i>				<i>[Signature]</i>				<i>[Signature]</i>			
TRAINING OFFICER				<i>[Signature]</i>	<i>[Signature]</i>	<i>[Signature]</i>	<i>[Signature]</i>	<i>[Signature]</i>	<i>[Signature]</i>	<i>[Signature]</i>	<i>[Signature]</i>	<i>[Signature]</i>	<i>[Signature]</i>	<i>[Signature]</i>	<i>[Signature]</i>	<i>[Signature]</i>	<i>[Signature]</i>	<i>[Signature]</i>	<i>[Signature]</i>	<i>[Signature]</i>	<i>[Signature]</i>	<i>[Signature]</i>	<i>[Signature]</i>
PRINCIPAL																							



PRINCIPAL
K.S.R. COLLEGE OF ENGINEERING
K.S.R. KALVI NAGAR,
TIRUCHENGODE-637 215

K.S.R. COLLEGE OF ENGINEERING (AUTONOMOUS), TIRUCHENGODE - 637 215
TRAINING AND PLACEMENT

KSRCE - IT Service Specific Training 2022 for 2023 Batch (06.04.2022 to 18.04.2022)

S.No	Reg No	Name	Branch	14.04.2022				15.04.2022				16.04.2022				17.04.2022				18.04.2022			
				FN	AN	EVE	NGT	FN	AN	EVE	NGT	FN	AN	EVE	NGT	FN	AN	EVE	NGT	FN	AN	EVE	NGT
1	1912003	GOWTHAM M	CIVIL	A	A	A	A	/	/	/	/	/	/	/	/	/	/	/	/	/	/	/	/
2	1912005	KAVINRAJ T	CIVIL	A	A	A	A	/	/	/	/	/	/	/	/	/	/	/	/	/	/	/	/
3	1912014	SATHISHKUMAR M	CIVIL	A	A	A	A	/	/	/	/	/	/	/	/	/	/	/	/	/	/	/	/
4	1912016	SOHAIL MAQBOOL BHAT	CIVIL	/	/	/	/	/	/	/	/	/	/	/	/	/	/	/	/	/	/	/	/
TOTAL				4	4	4	4	4	4	4	4	4	4	4	4	4	4	4	4	4	4	4	4
PRESENT				1	1	1	1	4	4	4	4	4	4	4	4	4	4	4	4	4	4	4	4
ABSENT				3	3	3	3	-	-	-	-	-	-	-	-	-	-	-	-	-	-	-	-
PLACEMENT CO ORDINATOR SIGN				<i>[Signature]</i>	<i>[Signature]</i>	<i>[Signature]</i>	<i>[Signature]</i>	<i>[Signature]</i>	<i>[Signature]</i>	<i>[Signature]</i>	<i>[Signature]</i>	<i>[Signature]</i>	<i>[Signature]</i>	<i>[Signature]</i>	<i>[Signature]</i>	<i>[Signature]</i>	<i>[Signature]</i>	<i>[Signature]</i>	<i>[Signature]</i>	<i>[Signature]</i>	<i>[Signature]</i>	<i>[Signature]</i>	
HOD SIGN				<i>[Signature]</i>	<i>[Signature]</i>	<i>[Signature]</i>	<i>[Signature]</i>	<i>[Signature]</i>	<i>[Signature]</i>	<i>[Signature]</i>	<i>[Signature]</i>	<i>[Signature]</i>	<i>[Signature]</i>	<i>[Signature]</i>	<i>[Signature]</i>	<i>[Signature]</i>	<i>[Signature]</i>	<i>[Signature]</i>	<i>[Signature]</i>	<i>[Signature]</i>	<i>[Signature]</i>	<i>[Signature]</i>	
TRAINING OFFICER				<i>[Signature]</i>	<i>[Signature]</i>	<i>[Signature]</i>	<i>[Signature]</i>	<i>[Signature]</i>	<i>[Signature]</i>	<i>[Signature]</i>	<i>[Signature]</i>	<i>[Signature]</i>	<i>[Signature]</i>	<i>[Signature]</i>	<i>[Signature]</i>	<i>[Signature]</i>	<i>[Signature]</i>	<i>[Signature]</i>	<i>[Signature]</i>	<i>[Signature]</i>	<i>[Signature]</i>	<i>[Signature]</i>	
PRINCIPAL				<i>[Signature]</i>	<i>[Signature]</i>	<i>[Signature]</i>	<i>[Signature]</i>	<i>[Signature]</i>	<i>[Signature]</i>	<i>[Signature]</i>	<i>[Signature]</i>	<i>[Signature]</i>	<i>[Signature]</i>	<i>[Signature]</i>	<i>[Signature]</i>	<i>[Signature]</i>	<i>[Signature]</i>	<i>[Signature]</i>	<i>[Signature]</i>	<i>[Signature]</i>	<i>[Signature]</i>	<i>[Signature]</i>	



[Signature]
PRINCIPAL
 K.S.R. COLLEGE OF ENGINEERING
 K.S.R. KALVI NAGAR,
 TIRUCHENGODE-637 215

K.S.R. COLLEGE OF ENGINEERING (AUTONOMOUS), TIRUCHENGODE - 637 215

TRAINING AND PLACEMENT

KSRCE - IT Service Specific Training 2022 for 2023 Batch (06.04.2022 to 13.04.2022)

S.No	Reg No	Name	Branch	06.04.2022				07.04.2022				08.04.2022				09.04.2022				10.04.2022				11.04.2022				12.04.2022				13.04.2022							
				FN	AN	EVE	NGT	FN	AN	EVE	NGT	FN	AN	EVE	NGT	FN	AN	EVE	NGT	FN	AN	EVE	NGT	FN	AN	EVE	NGT	FN	AN	EVE	NGT	FN	AN	EVE	NGT				
1	1912003	GOWTHAM M	CIVIL	/	/	/	/	/	/	/	/	/	/	/	/	/	/	/	/	A	A	A	A	/	/	/	/	/	/	/	/	/	/	/	/	/	/	/	/
2	1912005	KAVINRAJ T	CIVIL	/	/	/	/	/	/	/	/	/	/	/	/	/	/	/	/	A	A	A	A	/	/	/	/	/	/	/	/	/	/	/	/	/	/	/	/
3	1912014	SATHISHKUMAR M	CIVIL	/	/	/	/	/	/	/	/	/	/	/	/	/	/	/	/	A	A	A	A	/	/	/	/	/	/	/	/	/	/	/	/	/	/	/	/
4	1912016	SOHAIL MAQBOOL BHAT	CIVIL	/	/	/	/	/	/	/	/	/	/	/	/	/	/	/	/	/	/	/	/	/	/	/	/	/	/	/	/	/	/	/	/	/	/	/	/
TOTAL				4	4	4	4	4	4	4	4	4	4	4	4	4	4	4	4	4	4	4	4	4	4	4	4	4	4	4	4	4	4	4	4	4	4	4	4
PRESENT				4	4	4	4	4	4	4	4	4	4	4	4	4	4	4	4	1	1	1	1	4	4	4	4	4	4	4	4	4	4	4	4	4	4	4	4
ABSENT				-	-	-	-	-	-	-	-	-	-	-	-	-	-	-	-	3	3	3	3	-	-	-	-	-	-	-	-	-	-	-	-	-	-	-	-
PLACEMENT CO ORDINATOR SIGN				<i>[Signature]</i>	<i>[Signature]</i>	<i>[Signature]</i>	<i>[Signature]</i>	<i>[Signature]</i>	<i>[Signature]</i>	<i>[Signature]</i>	<i>[Signature]</i>	<i>[Signature]</i>	<i>[Signature]</i>	<i>[Signature]</i>	<i>[Signature]</i>	<i>[Signature]</i>	<i>[Signature]</i>	<i>[Signature]</i>	<i>[Signature]</i>	<i>[Signature]</i>	<i>[Signature]</i>	<i>[Signature]</i>	<i>[Signature]</i>	<i>[Signature]</i>	<i>[Signature]</i>	<i>[Signature]</i>	<i>[Signature]</i>	<i>[Signature]</i>	<i>[Signature]</i>	<i>[Signature]</i>	<i>[Signature]</i>	<i>[Signature]</i>	<i>[Signature]</i>	<i>[Signature]</i>					
HOD SIGN				<i>[Signature]</i>	<i>[Signature]</i>	<i>[Signature]</i>	<i>[Signature]</i>	<i>[Signature]</i>	<i>[Signature]</i>	<i>[Signature]</i>	<i>[Signature]</i>	<i>[Signature]</i>	<i>[Signature]</i>	<i>[Signature]</i>	<i>[Signature]</i>	<i>[Signature]</i>	<i>[Signature]</i>	<i>[Signature]</i>	<i>[Signature]</i>	<i>[Signature]</i>	<i>[Signature]</i>	<i>[Signature]</i>	<i>[Signature]</i>	<i>[Signature]</i>	<i>[Signature]</i>	<i>[Signature]</i>	<i>[Signature]</i>	<i>[Signature]</i>	<i>[Signature]</i>	<i>[Signature]</i>	<i>[Signature]</i>	<i>[Signature]</i>	<i>[Signature]</i>	<i>[Signature]</i>					
TRAINING OFFICER				<i>[Signature]</i>	<i>[Signature]</i>	<i>[Signature]</i>	<i>[Signature]</i>	<i>[Signature]</i>	<i>[Signature]</i>	<i>[Signature]</i>	<i>[Signature]</i>	<i>[Signature]</i>	<i>[Signature]</i>	<i>[Signature]</i>	<i>[Signature]</i>	<i>[Signature]</i>	<i>[Signature]</i>	<i>[Signature]</i>	<i>[Signature]</i>	<i>[Signature]</i>	<i>[Signature]</i>	<i>[Signature]</i>	<i>[Signature]</i>	<i>[Signature]</i>	<i>[Signature]</i>	<i>[Signature]</i>	<i>[Signature]</i>	<i>[Signature]</i>	<i>[Signature]</i>	<i>[Signature]</i>	<i>[Signature]</i>	<i>[Signature]</i>	<i>[Signature]</i>	<i>[Signature]</i>					
PRINCIPAL				<i>[Signature]</i>	<i>[Signature]</i>	<i>[Signature]</i>	<i>[Signature]</i>	<i>[Signature]</i>	<i>[Signature]</i>	<i>[Signature]</i>	<i>[Signature]</i>	<i>[Signature]</i>	<i>[Signature]</i>	<i>[Signature]</i>	<i>[Signature]</i>	<i>[Signature]</i>	<i>[Signature]</i>	<i>[Signature]</i>	<i>[Signature]</i>	<i>[Signature]</i>	<i>[Signature]</i>	<i>[Signature]</i>	<i>[Signature]</i>	<i>[Signature]</i>	<i>[Signature]</i>	<i>[Signature]</i>	<i>[Signature]</i>	<i>[Signature]</i>	<i>[Signature]</i>	<i>[Signature]</i>	<i>[Signature]</i>	<i>[Signature]</i>	<i>[Signature]</i>	<i>[Signature]</i>					



[Signature]
 PRINCIPAL
 K.S.R. COLLEGE OF ENGINEERING
 K.S.R. KALVI NAGAR,
 TIRUCHENGODE-637 215

30	1915068	THILAGA S	ECE	/	/	/	/	/	/	/	/	/	/	/	/	/	/	/	/	/	/	/	
31	1915069	THILAKBALAJE SM	ECE	/	/	/	/	/	/	/	/	/	/	/	/	/	/	/	/	/	/	/	
32	1915070	THIRUMURUGAN V	ECE	/	/	/	/	/	/	/	/	/	/	/	/	/	/	/	/	/	/	/	
33	1915071	VASANTH R	ECE	/	/	/	/	/	/	/	/	/	/	/	/	/	/	/	/	/	/	/	
34	1915072	VIGNESH V	ECE	/	/	/	/	/	/	/	/	/	/	/	/	/	/	/	/	/	/	/	
35	1915074	VINOTHINI G	ECE	/	/	/	/	/	/	/	/	/	/	/	/	/	/	/	/	/	/	/	
36	1915502	SREE HARISH N	ECE	/	/	/	/	/	/	/	/	/	/	/	/	/	/	/	/	/	/	/	
37	1915503	TAMILSHRI S	ECE	A	A	A	A	/	/	/	/	A	A	A	A	A	A	A	A	A	A	A	
38	1915002	ARAVINTHAN T	ECE	/	/	/	/	/	/	/	/	/	/	/	/	/	/	/	/	/	/	/	
39	1915009	GOWRIMANOHARI S	ECE	/	/	/	/	/	/	/	/	/	/	/	/	/	/	/	/	/	/	/	
40	1915025	KISHORE D	ECE	/	/	/	/	/	/	/	/	/	/	/	/	/	/	/	/	/	/	/	
41	1915036	MONISHA D	ECE	/	/	/	/	/	/	/	/	/	/	/	/	/	/	/	/	/	/	/	
42	1915038	NAVEENA. M	ECE	/	/	/	/	/	/	/	/	/	/	/	/	/	/	/	/	A	A	A	
43	1915055	SHARAN S	ECE	/	/	/	/	/	/	/	/	/	/	/	/	/	/	/	/	/	/	/	
44	1915059	SREE GANESH M	ECE	/	/	/	/	/	/	/	/	/	/	/	/	/	/	/	/	/	/	/	
45	1915061	SUBASHINI E	ECE	/	/	/	/	/	/	/	/	/	/	/	/	/	/	/	/	A	A	A	
46	1915075	YOGESH. R	ECE	/	/	/	/	/	/	/	/	/	/	/	/	/	/	/	/	/	/	/	
47	1915003	ARUNKUMAR S	ECE	A	A	A	A	/	/	/	/	/	/	/	/	/	/	/	/	/	/	/	
48	1915030	MAGIBALAN R	ECE	/	/	/	/	/	/	/	/	/	/	/	A	A	A	A	/	/	/	/	
49	1915033	MOHAN S	ECE	/	/	/	/	/	/	/	/	/	/	/	/	/	/	/	/	/	/	/	
50	1915034	MOHANASELVAN.D.V	ECE	/	/	/	/	/	/	/	/	/	/	/	/	/	/	/	/	/	/	/	
51	1915035	MOHANPRASATH.A	ECE	/	/	/	/	/	/	/	/	/	/	/	/	/	/	/	/	/	/	/	
52	1915039	PERUMAL R	ECE	/	/	/	/	/	/	/	/	/	/	/	/	/	/	/	/	/	/	/	
53	1915052	SELVA PRAVEEN S	ECE	/	/	/	/	/	/	/	/	/	/	/	/	/	/	/	/	/	/	/	
TOTAL				53	53	53	53	53	53	53	53	53	53	53	53	53	53	53	53	53	53	53	
PRESENT				48	48	48	48	49	49	49	49	49	49	49	49	48	48	48	48	49	49	49	49
ABSENT				5	5	5	5	4	4	4	4	4	4	4	5	5	5	5	4	4	4	4	4
PLACEMENT CO ORDINATOR SIGN				[Signatures]																			
HOD SIGN				[Signatures]																			
TRAINING OFFICER				[Signatures]																			
PRINCIPAL				[Signatures]																			

PRINCIPAL
K.S.R. COLLEGE OF ENGINEERING
K.S.R. KALVI NAGAR,
TIRUCHENGODE-637 215

K.S.R. COLLEGE OF ENGINEERING (AUTONOMOUS), TIRUCHENGODE - 637 215

TRAINING AND PLACEMENT

KSRCE - IT Service Specific Training 2022 for 2023 Batch (06.04.2022 to 20.04.2022)

S.No	Reg No	Name	Branch	14.04.2022				15.04.2022				16.04.2022				17.04.2022				18.04.2022			
				FN	AN	EVE	NIT	FN	AN	EVE	NIT	FN	AN	EVE	NIT	FN	AN	EVE	NIT	FN	AN	EVE	NIT
1	1914001	ABINAYA N	EEE	/	/	/	/	/	/	/	/	/	/	A	/	/	/	/	/	/	/	/	
2	1914007	DINESHWARAN K	EEE	/	/	/	/	/	/	/	/	/	/	/	/	/	/	/	/	/	/	/	
3	1914008	DIVAKAR V	EEE	/	/	/	/	/	/	/	/	/	/	/	/	/	/	/	/	/	/	/	
4	1914010	HARI GOKUL S	EEE	/	/	/	/	/	/	/	/	/	/	/	/	/	/	/	/	/	/	/	
5	1914017	KAARTHIKEYAN S	EEE	/	/	/	/	/	/	/	/	/	/	/	/	/	/	/	/	/	/	/	
6	1914018	KABEENA K J	EEE	/	/	/	/	/	/	/	/	/	A	/	/	/	/	/	/	/	/	/	
7	1914021	KAVIN J R	EEE	/	/	/	/	/	/	/	/	/	/	/	/	/	/	/	/	/	/	/	
8	1914025	KOWSIKPRABU R	EEE	/	/	/	/	/	/	/	/	/	/	/	/	/	/	/	/	/	/	/	
9	1914026	MOHAMMED AL FAHAD	EEE	OD	OD	OD	OD	OD	OD	OD	OD	OD	OD	OD	OD	OD	OD	OD	OD	OD	OD	OD	
10	1914028	MOHAN R	EEE	/	/	/	/	/	/	/	/	/	/	/	/	/	/	/	/	/	/	/	
11	1914029	NALAN R	EEE	/	/	/	/	/	/	/	/	/	/	/	/	/	/	/	/	/	/	/	
12	1914031	NAVEEN KUMAR P	EEE	/	/	/	/	/	/	/	/	/	/	/	/	/	/	/	/	/	/	/	
13	1914036	RANJITHKUMAR R	EEE	/	/	/	/	/	/	/	/	/	/	/	/	/	/	/	/	/	/	/	
14	1914039	SATHISHKUMAR A	EEE	/	/	/	/	/	/	/	/	/	/	/	/	/	/	/	/	/	/	/	
15	1914041	SIVAKUMAR S	EEE	/	/	/	/	/	/	/	/	/	/	/	/	/	/	/	/	/	/	/	
16	1914042	SOMESHKANNAN V	EEE	/	/	/	/	/	/	/	/	/	/	/	/	/	/	/	/	/	/	/	
17	1914043	SRIDHAR A	EEE	/	/	/	/	/	/	/	/	/	/	/	/	/	/	/	/	/	/	/	
18	1914046	SURYAPRAKASH S	EEE	/	/	/	/	/	/	/	/	/	/	/	/	/	/	/	/	/	/	/	
19	1914047	THANUJA G V	EEE	/	/	/	/	/	/	/	/	/	/	/	/	/	/	/	/	/	/	/	
20	1914049	VIGNESH E	EEE	/	/	/	/	/	/	/	/	A	A	A	A	/	/	/	/	/	/	/	
21	1914051	YOGESHRAJ P	EEE	/	/	/	/	/	/	/	/	A	A	A	A	/	/	/	/	/	/	/	
22	1914508	NAVANEETHAKRISHNAN	EEE	/	/	/	/	/	/	/	/	A	A	A	A	A	A	A	A	A	A	A	
TOTAL				22	22	22	22	22	22	22	22	22	22	22	22	22	22	22	22	22	22	22	22
PRESENT				22	22	22	22	22	22	22	22	22	22	22	22	22	22	22	22	22	22	22	22
ABSENT				-	-	-	-	-	-	-	-	03	03	03	05	01	01	01	01	01	01	01	01
PLACEMENT CO ORDINATOR SIGN				[Signature]				[Signature]				[Signature]				[Signature]				[Signature]			
HOD SIGN				[Signature]				[Signature]				[Signature]				[Signature]				[Signature]			
TRAINING OFFICER				[Signature]				[Signature]				[Signature]				[Signature]				[Signature]			
PRINCIPAL				[Signature]				[Signature]				[Signature]				[Signature]				[Signature]			

PRINCIPAL
K.S.R. COLLEGE OF ENGINEERING
K.S.R. KALVI NAGAR,
TIRUCHENGODE-637 215

35	1921041	S.RAJKUMAR	IT	/	/	/	/	/	/	/	/	/	/	/	/	/	/	/	/	/	
36	1921042	RAMESHKRISHNAN M	IT	/	/	/	/	/	/	/	/	/	/	/	/	/	/	/	/	/	
37	1921043	RANJITH KUMAR T	IT	/	/	/	/	a	a	a	a	a	a	a	/	/	/	/	/	/	
38	1921045	SARAVANAN B	IT	/	/	/	/	/	/	/	/	/	/	/	/	/	/	/	/	/	
39	1921046	SASIDHARAN.S	IT	/	/	/	/	a	a	a	a	a	a	a	/	/	/	/	/	/	
40	1921047	B.SNEKA	IT	/	/	/	/	/	/	/	/	/	/	/	/	/	/	/	/	/	
41	1921048	SOHAIL AHMED M	IT	/	/	/	/	/	/	/	/	/	/	/	/	/	/	/	a	a	
42	1921049	SOUNDAR M	IT	/	/	/	/	/	/	/	/	/	/	/	/	/	/	/	/	/	
43	1921051	N SOWMIYA	IT	/	/	/	/	/	/	/	/	/	/	/	/	/	/	/	/	/	
44	1921052	STEFFI GRAF.R	IT	a	a	a	a	a	a	a	a	a	a	a	a	a	a	/	/	/	
45	1921055	SURYA	IT	/	/	/	/	/	/	/	/	/	/	/	/	/	/	/	/	/	
46	1921056	P.THANIYFAL	IT	/	/	/	/	/	/	/	/	/	/	/	/	/	/	/	/	/	
47	1921057	P.S.THAVANISH	IT	/	/	/	/	/	/	/	/	/	/	/	/	/	/	/	/	/	
48	1921058	THINAKARAN P	IT	/	/	/	/	/	/	/	/	/	/	/	/	/	/	/	/	/	
49	1921060	B.VISHNU	IT	a	a	a	a	a	a	a	a	a	a	a	/	/	/	/	/	/	
50	1921050	B.SOWMIYA	IT	/	/	/	/	/	/	/	/	/	/	/	/	/	/	/	/	/	
51	1921044	G.SANTHOSH	IT	/	/	/	/	/	/	/	/	/	/	/	/	/	/	/	a	a	
52	1921054	J.SUREENDHAR	IT	/	/	/	/	/	/	/	/	/	/	/	/	/	/	/	/	/	
53	1921059	J E VIJAY	IT	/	/	/	/	/	/	/	/	/	/	/	/	/	/	/	/	/	
TOTAL				53	53	53	53	53	53	53	53	53	53	53	53	53	53	53	53	53	53
PRESENT				51	51	51	51	48	48	48	48	48	48	48	48	50	50	50	50	49	49
ABSENT				2	2	2	2	5	5	5	5	5	5	5	3	3	3	3	4	4	4
PLACEMENT CO ORDINATOR SIGN				<i>[Signature]</i>	<i>[Signature]</i>	<i>[Signature]</i>	<i>[Signature]</i>	<i>[Signature]</i>	<i>[Signature]</i>	<i>[Signature]</i>	<i>[Signature]</i>	<i>[Signature]</i>	<i>[Signature]</i>	<i>[Signature]</i>	<i>[Signature]</i>	<i>[Signature]</i>	<i>[Signature]</i>	<i>[Signature]</i>	<i>[Signature]</i>	<i>[Signature]</i>	<i>[Signature]</i>
HOD SIGN				<i>[Signature]</i>	<i>[Signature]</i>	<i>[Signature]</i>	<i>[Signature]</i>	<i>[Signature]</i>	<i>[Signature]</i>	<i>[Signature]</i>	<i>[Signature]</i>	<i>[Signature]</i>	<i>[Signature]</i>	<i>[Signature]</i>	<i>[Signature]</i>	<i>[Signature]</i>	<i>[Signature]</i>	<i>[Signature]</i>	<i>[Signature]</i>	<i>[Signature]</i>	<i>[Signature]</i>
TRAINING OFFICER				<i>[Signature]</i>	<i>[Signature]</i>	<i>[Signature]</i>	<i>[Signature]</i>	<i>[Signature]</i>	<i>[Signature]</i>	<i>[Signature]</i>	<i>[Signature]</i>	<i>[Signature]</i>	<i>[Signature]</i>	<i>[Signature]</i>	<i>[Signature]</i>	<i>[Signature]</i>	<i>[Signature]</i>	<i>[Signature]</i>	<i>[Signature]</i>	<i>[Signature]</i>	<i>[Signature]</i>
PRINCIPAL				<i>[Signature]</i>	<i>[Signature]</i>	<i>[Signature]</i>	<i>[Signature]</i>	<i>[Signature]</i>	<i>[Signature]</i>	<i>[Signature]</i>	<i>[Signature]</i>	<i>[Signature]</i>	<i>[Signature]</i>	<i>[Signature]</i>	<i>[Signature]</i>	<i>[Signature]</i>	<i>[Signature]</i>	<i>[Signature]</i>	<i>[Signature]</i>	<i>[Signature]</i>	<i>[Signature]</i>



PRINCIPAL
K.S.R. COLLEGE OF ENGINEERING
K.S.R. KALVI NAGAR,
TIRUCHENGODE-637 215

K.S.R. COLLEGE OF ENGINEERING (AUTONOMOUS), TIRUCHENGODE - 637 2

TRAINING AND PLACEMENT

KSRCE - IT Service Specific Training 2022 for 2023 Batch (06.04.2022 to 18.04.2022)

S.No	Reg No	Name	Branch	15.04.2022				16.04.2022				17.04.2022				18.04.2022			
				FN	AN	EVE	NGT	FN	AN	EVE	NGT	FN	AN	EVE	NGT	FN	AN	EVE	NGT
1	1916013	GNANASELVARAJ P	MECH	/	/	/	/	/	/	/	/	/	/	/	/	/	/	/	
2	1916014	GOKUL C	MECH	/	/	/	/	/	/	/	/	/	/	/	/	/	/	/	
3	1916020	KAMESH S	MECH	/	/	/	/	/	/	/	/	/	/	/	/	/	/	/	
4	1916021	KAVI M	MECH	/	/	/	/	/	/	/	/	/	/	/	/	/	/	/	
5	1916053	VELMURUGAN.A	MECH	/	/	/	/	/	/	/	/	/	/	/	/	/	/	/	
6	1916502	ARUNKUMAR M	MECH	/	/	/	/	/	/	/	/	/	/	/	/	/	/	/	
7	1916505	DHARUNPRASATH.V	MECH	/	/	/	/	/	/	/	/	/	/	/	/	/	/	/	
8	1916507	MOHAMED FAIZUL	MECH	/	/	/	/	/	/	/	/	/	/	/	/	/	/	/	
9	1916513	KISHORE G	MECH	/	/	/	/	/	/	/	/	/	/	/	/	/	/	/	
10	1916514	LOGESHWARAN M	MECH	/	/	/	/	/	/	/	/	/	/	/	/	/	/	/	
11	1916515	MAKESKUMAR C	MECH	/	/	/	/	/	/	/	/	/	/	/	/	/	/	/	
12	1916516	MANOJ G	MECH	/	/	/	/	/	/	/	/	/	/	/	/	/	/	/	
13	1916517	MOHANRAJA R	MECH	/	/	/	/	/	/	/	/	/	/	/	/	/	/	/	
14	1916520	NANDHAKUMAR S	MECH	/	/	/	/	/	/	/	/	/	/	/	/	/	/	/	
15	1916521	NAVEENKUMAR P	MECH	/	/	/	/	/	/	/	/	/	/	/	/	/	/	/	
16	1916024	KAVINESH S	MECH	a	a	a	a	/	/	/	/	/	/	/	/	/	/	/	
17	1916525	SAKTHIVEL.K	MECH	/	/	/	/	/	/	/	/	/	/	/	/	/	/	/	
18	1916526	SAKTHIVELAN N	MECH	/	/	/	/	/	/	/	/	/	/	/	/	/	/	/	
19	1916533	VASANTHAKUMAR K	MECH	/	/	/	/	/	/	/	/	/	/	/	/	/	/	/	
20	1916501	AJAYPRASANTH M	MECH	a	a	a	a	/	/	/	/	/	/	/	/	/	/	/	
21	1916503	DEEPANKUMAR K	MECH	/	/	/	/	/	/	/	/	/	/	/	/	/	/	/	
22	1916506	DHUVARAGA PRASATH.S	MECH	/	/	/	/	/	/	/	/	/	/	/	/	/	/	/	
23	1916511	JAGADESH. J	MECH	/	/	/	/	a	a	a	a	/	/	/	/	/	/	/	
24	1916512	KALAIYARASAN T	MECH	/	/	/	/	/	/	/	/	/	/	/	/	/	/	/	
25	1916522	NIHIL R	MECH	/	/	/	/	/	/	/	/	/	/	/	/	/	/	/	
26	1916039	PUVIARASU	MECH	/	/	/	/	/	/	/	/	/	/	/	/	/	/	/	
27	1916049	SURESH PRABU	MECH	/	/	/	/	/	/	/	/	/	/	/	/	/	/	/	
TOTAL				27	27	27	27	27	27	27	27	27	27	27	27	27	27	27	27
PRESENT				25	25	25	25	26	26	26	26	26	26	26	26	26	26	26	26
ABSENT				2	2	2	2	1	1	1	1	1	1	1	1	1	1	1	1
PLACEMENT CO ORDINATOR SIGN				S	S	S	S	S	S	S	S	S	S	S	S	S	S	S	S
HOD SIGN				A	A	A	A	A	A	A	A	A	A	A	A	A	A	A	A
TRAINING OFFICER				S	S	S	S	S	S	S	S	S	S	S	S	S	S	S	S
PRINCIPAL				S	S	S	S	S	S	S	S	S	S	S	S	S	S	S	S

PRINCIPAL
K.S.R. COLLEGE OF ENGINEERING
K.S.R. KALVI NAGAR,
TIRUCHENGODE-637 215





KSRCE/QM/8.6/22/PDC

K.S.R. COLLEGE OF ENGINEERING

(Autonomous)

TIRUCHENGODE - 637 715 TAMIL NADU, INDIA

Approved by AICTE, New Delhi, Anna University, Chennai & Accredited by NBA and NAAC with 'A' Grade

Professionals Development Cell

Certificate of Participation

This is to certify that Mr./Ms..... PRASANTH R......
 of..... INFORMATION TECHNOLOGY..... department has participated in the
 IT SPECIFIC TRAINING.....
 programme held at TRAINING AND PLACEMENT CELL - KSRCE.....
 on 6.4.22 - 20.4.22... We wish the student all success.

Date: 20.4.2022

[Signature]
 Organizer



[Signature]
 Co-ordinator



[Signature]
 Principal
 K.S.R. COLLEGE OF ENGINEERING
 K.S.R. KALVI NAGAR
 TIRUCHENGODE-637 715



HIGHER EDUCATIONAL CELL





KSRCE/QM/8.6/22/PDC

K.S.R. COLLEGE OF ENGINEERING

(Autonomous)

TIRUCHENGODE - 637 215, TAMIL NADU, INDIA.

Approved by AICTE, New Delhi, Anna University, Chennai & Accredited by NBA and NAAC with 'A' Grade

Professionals Development Cell

Certificate of Participation

This is to certify that Mr./Ms..... SANTJAY R.....
 of ELECTRONICS AND COMMUNICATION ENGINEERING department has participated in the
IT SPECIFIC TRAINING
 programme held at TRAINING AND PLACEMENT CELL - KSRCE
on 6.4.22 - 20.4.22. We wish the student all success.

Date: 20.4.2022

G. Pragnya
Organizer

G. P. P.
Co-ordinator

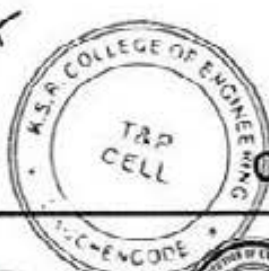

[Signature]
Principal

PRINCIPAL
K.S.R. COLLEGE OF ENGINEERING
K.S.R. KALVI NAGAR,
TIRUCHENGODE-637 215



HIGHER EDUCATIONAL CELL





K.S.R. COLLEGE OF ENGINEERING

(Autonomous)

TIRUCHENGODE - 637 215.TAMILNADU, INDIA.

Approved by AICTE, New Delhi, Anna University, Chennai & Accredited by NBA and NAAC with 'A' Grade

Professionals Development Cell

Certificate of Participation

This is to certify that Mr./Ms.....ASIK A.....
of COMPUTER SCIENCE AND ENGINEERING.....department has participated in the
.....IT SPECIFIC TRAINING.....
programme held at TRAINING AND PLACEMENT CELL - KSRCE.....
on 6.4.22 - 20.4.22 We wish the student all success.

Date: 20.04.2022  Organizer

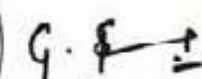
  Co-ordinator

   Principal
K.S.R. COLLEGE OF ENGINEERING
K.S.R. KALVI NAGAR
TIRUCHENGODE-637 215



HIGHER EDUCATIONAL CELL





KSRCE/QM/8.6/22/PDC

K.S.R. COLLEGE OF ENGINEERING

(Autonomous)

TIRUCHENGODE - 637 215.TAMILNADU, INDIA.

Approved by AICTE, New Delhi, Anna University, Chennai & Accredited by NBA and NAAC with 'A' Grade

Professionals Development Cell

Certificate of Participation

This is to certify that Mr./Ms..... GOWTHAM M......

of..... CIVIL ENGINEERING..... department has participated in the

IT SPECIFIC TRAINING

programme held at TRAINING AND PLACEMENT CELL - KSRCE

on 06.04.22 - 20.4.22. We wish the student all success.

Date: 20.04.2022

S. Ganesh
Organizer

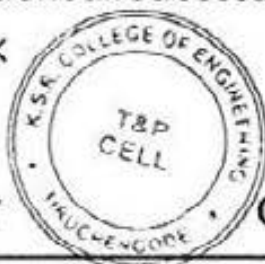

G. S.
Co-ordinator



[Signature]
Principal

[Signature]
Principal

PRINCIPAL
K.S.R. COLLEGE OF EN
K.S.R. KALVI NA
TIRUCHENGODE-6
215



HIGHER EDUCATIONAL CELL



2021-2022
(29)

KSRCE/IQAC/2021-2022/T&P/IC26C-64/57
K.S.R. COLLEGE OF ENGINEERING, TIRUCHENGODE - 637 215
(Autonomous)

DATE: 18.04.2022

TIME: 03.00 p.m.

CIRCULAR

CLASSIFICATION	ROUTINE	IMMEDIATE
ORIGINATOR: PRINCIPAL	CIRCULATED TO: MCA HoD	

Sub.: IT Specific Training for MCA First Year Students (2024 Batch) - Reg.

IT Specific Training for MCA First Year Students (2024 Batch) has been organized from 19th April 2022 to 03rd MAY 2022 (13 Days). The morning session will be conducted from 09.00 am to 12.30 pm, the afternoon session will be from 01.30 pm to 06.30 pm. So, all the regular classes will be canceled for the training program. Concerned HoD requested to instruct their students to attend the whole training without fail.

Instructions to the Faculty through HoD

1. Department T&P Co-ordinator requested to monitor the attendance & discipline matters throughout the training program and update the HoD's concerned every day.

Instructions to the Students through Department T&P Co-ordinators & HoDs

1. Dress Code (Self Grooming, Formalwear with shoes)
2. Discipline
3. Punctuality

If any student not follows the above he/she may not be allowed to proceed further in the process.

TRAINING OFFICER

PRINCIPAL

Copy to:

1. MCA HOD for favor of information and circulation among current first year students and faculty members concerned.
2. MCA Training & Placement Coordinator.
3. Department Notice board.

EVIDENCE OF COMPLETION

Number of persons not received / seen: _____

Signature of Originator with date and time: _____



PRINCIPAL
K.S.R. COLLEGE OF ENGINEERING
K.S.R. KALVI NAGAR,
TIRUCHENGODE-637 215
TIRUCHENGODE-637 215
K.S.R. COLLEGE OF ENGINEERING
K.S.R. KALVI NAGAR,
TIRUCHENGODE-637 215

				6	6	6	7	7	7	8	8	8	9	9	9	10	10	10	11	11	11	12	12	12	13	13	13	14	14	14	
31	2162034	PRATHEEP M	MCA	/	/	/	/	/	/	/	/	/	/	/	/	/	/	/	/	/	/	/	/	/	/	/	/	/	/		
32	2162035	PRAVEEN M	MCA	/	/	/	/	/	/	/	/	/	/	/	/	/	/	/	/	/	/	/	/	/	/	/	/	/	/		
33	2162036	PREETHI V	MCA	/	/	/	/	/	/	/	/	/	/	/	/	/	/	/	/	/	/	/	/	/	/	/	/	/	/		
34	2162037	RANJANA P	MCA	/	/	/	/	/	/	/	/	/	/	/	/	/	/	/	/	/	/	/	/	/	/	/	/	/	/		
35	2162038	ROGEETH NARAYANAN V S	MCA	/	/	/	/	/	/	/	/	/	/	/	/	/	/	/	/	/	/	/	/	/	/	/	/	/	/		
36	2162039	SAKTHI V A	MCA	/	/	/	/	/	/	/	/	/	/	/	/	/	/	/	/	/	/	/	/	/	aaa	/	/	/	/		
37	2162040	SANDEEPRAJ R	MCA	/	/	/	/	/	/	/	/	/	/	/	/	/	/	/	/	/	/	/	/	/	/	aaa	/	/	/		
38	2162041	SANJAI A	MCA	/	/	/	/	/	/	/	/	/	/	/	/	/	/	/	/	/	/	/	/	/	/	/	/	/	/		
39	2162042	SASIESWARAN C	MCA	/	/	/	/	/	/	/	/	/	/	/	/	/	/	/	/	/	/	/	/	/	/	/	/	/	/		
40	2162044	SIVAKUMAR T	MCA	aaa	/	/	/	/	/	/	/	/	/	/	/	/	/	/	/	/	/	/	/	aaa	/	/	/	/	/		
41	2162045	SIVARANGANATHAN K	MCA	aaa	/	/	/	/	/	/	/	/	/	/	/	/	/	/	/	/	/	/	/	/	/	/	/	/	/		
42	2162046	SIVASAKTHI M	MCA	/	/	/	/	/	/	/	/	/	/	/	/	/	/	/	/	/	/	/	/	aaa	/	/	/	/	/		
43	2162047	SIVASHANKAR R	MCA	/	/	/	/	/	/	/	/	/	/	/	/	/	/	/	/	/	/	/	/	/	/	aaa	/	/	/		
44	2162048	SOMASUNDAR G	MCA	/	/	/	/	/	/	/	/	/	/	/	/	/	/	/	/	/	/	/	/	/	/	/	/	/	/		
45	2162049	SOWMIYA A	MCA	aaa	/	/	/	/	/	/	/	/	/	/	/	/	/	/	/	/	/	/	/	/	/	/	/	/	/		
46	2162050	SOWNDARRAJAN N	MCA	/	/	/	/	/	/	/	/	/	/	/	/	/	/	/	/	/	/	/	/	/	/	/	/	/	/		
47	2162051	SOWNTHARYA G	MCA	/	/	/	/	/	/	/	/	/	/	/	/	/	/	/	/	/	/	/	/	/	/	/	/	/	/		
48	2162053	THIYAGARAJ S	MCA	/	/	/	/	/	/	/	/	/	/	/	/	/	/	/	/	/	/	/	/	/	/	/	/	/	/		
49	2162054	VASANTHAKUMAR R	MCA	/	/	/	/	/	/	/	/	/	/	/	/	/	/	/	/	/	/	/	/	/	/	/	/	/	/		
50	2162055	VASANTHAKUMAR R	MCA	/	/	/	/	/	/	/	/	/	/	/	/	/	/	/	/	/	/	/	/	/	/	aaa	/	/	/		
51	2162056	VENKATESH B	MCA	/	/	/	/	/	/	/	/	/	/	/	/	/	/	/	/	/	/	/	/	/	/	/	/	/	/		
52	2162057	VIDHYADHARAN P	MCA	/	/	/	/	/	/	/	/	/	/	/	/	/	/	/	/	/	/	/	/	/	/	/	/	/	/		
53	2162058	VINOTHKUMAR T	MCA	aaa	/	/	/	/	/	/	/	/	/	/	/	/	/	/	/	/	/	/	/	/	/	aaa	/	/	/		
54	2162059	VISHWA K	MCA	/	/	/	/	/	/	/	/	/	/	/	/	/	/	/	/	/	/	/	/	/	aaa	/	/	/	/		
55	2162060	YOGESHWARAN S K	MCA	/	/	/	/	/	/	/	/	/	/	/	/	/	/	/	/	/	/	/	/	/	aaa	/	/	/	/		
TOTAL				55	55	55	55	55	55	55	55	55	55	55	55	55	55	55	55	55	55	55	55	55	55	55	55	55	55	55	
PRESENT				49	49	49	50	50	50	50	50	50	50	50	50	50	50	50	50	50	50	50	50	50	50	50	50	50	50	50	
ABSENT				06	06	06	0	0	0	0	0	0	0	0	0	0	0	0	0	0	0	0	0	0	05	05	05	04	04	04	
PLACEMENT CO ORDINATOR SIGN																															
HOD SIGN																															
TRAINING OFFICER																															
PRINCIPAL																															

PRINCIPAL
 K.S.R. COLLEGE OF ENGINEERING
 K.S.R. KALVI NAGAR,
 TIRUCHENGODE-637 215

KSR College of Engineering (Autonomous), Tiruchengode – 637 215

Training and Placement Cell

Phase – 1 Aptitude, Soft skill and Technical Training Schedule for 2023 Batch

FN	AN
Achievers Tech Talks	Interaction
Resume Building & Presentation	Essay writing & Group Discussion , Activity
SWOT Analysis & Self Introduction	Individual Activity
Permutation and Combination	Probability
Blood Relation, Syllogism	Directions, Coding and Decoding
JDK, JRE, JVM, Structure of Java class	Method overloading , Constructors
Datatypes & Operators, Identifiers	Inheritance , Polymorphism
Polymorphism	Wrapper Class
Exception Handling	String & String Builder

FN Session

9.30 am to 12.30 pm

AN Session

01.30 pm to 04.00 pm

Assessment

04.30 pm to 06.00 pm

*10.46 am – 11.00am - Break

*12.30 pm – 01.30 pm -Lunch Break

* 02.46 pm – 03.00 pm – Break

PRINCIPAL
K.S.R. COLLEGE OF ENGINEERING
K.S.R. KALVI NAGAR,
TIRUCHENGODE-637 215





KSRCE/QM/8.6/22/PDC

K.S.R. COLLEGE OF ENGINEERING

(Autonomous)

TIRUCHENGODE - 637 215. TAMILNADU, INDIA.

Approved by AICTE, New Delhi, Anna University, Chennai & Accredited by NBA and NAAC with 'A' Grade

Professionals Development Cell

Certificate of Participation

This is to certify that Mr./Ms. SOWMIYA . A

of MASTER OF COMPUTER APPLICATION department has participated in the

IT SPECIFIC TRAINING

programme held at TRAINING AND PLACEMENT CELL - KSRCE

on 19.4.22 - 03.5.22. We wish the student all success.

Date: 03.05.2022  Organizer

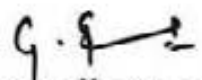

 Co-ordinator



 Principal

PRINCIPAL
K.S.R. COLLEGE OF ENGINEERING
K.S.R. KALVI NAGAR,
TIRUCHENGODE - 637 215



HIGHER EDUCATIONAL CELL





KSRCE/QM/8.6/22/PDC

K.S.R. COLLEGE OF ENGINEERING

(Autonomous)

TIRUCHENGODE - 637 215.TAMILNADU, INDIA.

Approved by AICTE, New Delhi, Anna University, Chennai & Accredited by NBA and NAAC with 'A' Grade

Professionals Development Cell

Certificate of Participation

This is to certify that Mr./Ms..... PRAVEEN M......
of..... MASTER OF COMPUTER APPLICATION..... department has participated in the
..... IT SPECIFIC TRAINING.....
programme held at TRAINING AND PLACEMENT CELL - KSRCE
on 19.4.22 - 25.4.22.. We wish the student all success.

Date: 03.05.2022

Organizer

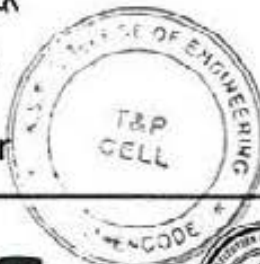

Co-ordinator



Principal
K.S.R. COLLEGE OF ENGINEERING
K.S.R. KALVI NAGAR
TIRUCHENGODE-637 215



HIGHER EDUCATIONAL CELL





KSRCE/QM/8.6/22/PDC

K.S.R. COLLEGE OF ENGINEERING

(Autonomous)

TIRUCHENGODE - 637 215. TAMILNADU, INDIA

Approved by AICTE, New Delhi, Anna University, Chennai & Accredited by NBA and NAAC with 'A' Grade

Professionals Development Cell

Certificate of Participation

This is to certify that Mr./Ms. KAVIYA : G1
 of MASTER OF COMPUTER APPLICATION department has participated in the
IT SPECIFIC TRAINING
 programme held at TRAINING AND PLACEMENT CELL - KSRCE
 on 19.4.22 - 3.5.22. We wish the student all success.

Date: 03.05.22

S. Anjitha
Organizer



G. F. S.
Co-ordinator



[Signature]
Principal

[Signature]

PRINCIPAL,
K.S.R. COLLEGE OF ENGINEERING
K.S.R. KALVI NAGAR,
TIRUCHENGODE-637 215



HIGHER
EDUCATIONAL
CELL





K.S.R. COLLEGE OF ENGINEERING

(Autonomous)

TIRUCHENGODE - 637 215 TAMIL NADU, INDIA.

Approved by AICTE, New Delhi, Anna University, Chennai & Accredited by NBA and NAAC with 'A' Grade

Professionals Development Cell

Certificate of Participation

This is to certify that Mr./Ms. BALAJI . V.....
 of MASTER OF COMPUTER APPLICATION..... department has participated in the
IT SPECIFIC TRAINING.....
 programme held at TRAINING AND PLACEMENT CELL - KSRCE.....
 on 19.4.22 - 3.5.22..... We wish the student all success.

Date: 03.05.2022

[Signature]
Organizer.

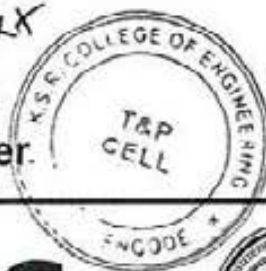

[Signature]
Co-ordinator



[Signature]
Principal

PRINCIPAL
K.S.R. COLLEGE OF ENGINEERING
K.S.R. KALVI NAGAR,
TIRUCHENGODE - 637 215



HIGHER EDUCATIONAL CELL



2021-2022
30

KSRCE/IQAC/2021-2022/T&P/IC26C-64/50
K.S.R. COLLEGE OF ENGINEERING, TIRUCHENGODE - 637 215
(Autonomous)

DATE: 21.04.2022

TIME: 02.00 p.m.

CIRCULAR

CLASSIFICATION	ROUTINE	IMMEDIATE
ORIGINATOR: PRINCIPAL		CIRCULATED TO: All UG HoDs

Sub.: Aptitude and Soft skill Training for all UG Second Year Students (2024 Batch) - Reg.

Aptitude and Soft skill Training for all UG Second Year Students (2024 Batch) has been organized from 25th April 2022 to 30th April 2022 (06 Days). The morning session will be conducted from 09.00 am to 12.30 pm, the afternoon session will be from 01.30 pm to 06.30 pm. So, all the regular classes will be canceled for the training program. Concerned HoDs are requested to instruct their students to attend the whole training without fail.

Instructions to the Faculty through HoDs

1. All the Department T&P Co-ordinators are requested to monitor the attendance & discipline matters throughout the training program and update the HoDs concerned every day.

Instructions to the Students through Department T&P Co-ordinators & HoDs

1. Dress Code (Self Grooming, Formalwear with shoes)
2. Discipline
3. Punctuality

If any student not follows the above he/she may not be allowed to proceed further in the process.

[Handwritten Signature]
21 APR 22
TRAINING OFFICER

[Handwritten Signature]
PRINCIPAL

Copy to:

1. All UG HODS for favor of information and circulation among current pre final year students and faculty members concerned.
2. All Training & Placement Coordinators.
3. Department Notice board.

EVIDENCE OF COMPLETION

Number of persons not received / seen: _____

Signature of Originator with date and time: _____



[Handwritten Signature]
PRINCIPAL
K.S.R. COLLEGE OF ENGINEERING
K.S.R. KALVI NAGAR,
TIRUCHENGODE-637 215

131	2013126	YUGA PRIYAN S	CSE	/	/	/	/	/	/	/	/	/	/	a	a
132	2013507	KAVIYA S	CSE	/	/	/	/	/	/	a	a	/	/	/	/
133	2013508	MYILSAMY S	CSE	/	/	/	/	/	/	/	/	/	/	/	/
134	2013509	NAVEEN S	CSE	/	/	a	a	/	/	/	/	/	/	/	/
135	2013510	SUBASH T	CSE	/	/	/	/	a	a	/	/	/	/	/	/
136	2013511	SYED IBRAHIM T	CSE	a	a	/	/	/	/	/	/	/	/	/	/
137	2013512	VANMATHI K	CSE	/	/	/	/	/	/	/	/	a	a	/	/
TOTAL				137	137	137	137	137	137	137	137	137	137	137	137
PRESENT				118	118	120	120	123	123	124	124	124	124	124	122
ABSENT				19	19	17	17	14	14	13	13	13	13	15	15
PLACEMENT CO ORDINATOR SIGN				<i>[Signature]</i>	<i>[Signature]</i>	<i>[Signature]</i>	<i>[Signature]</i>	<i>[Signature]</i>	<i>[Signature]</i>	<i>[Signature]</i>	<i>[Signature]</i>	<i>[Signature]</i>	<i>[Signature]</i>	<i>[Signature]</i>	<i>[Signature]</i>
HOD SIGN				<i>[Signature]</i>	<i>[Signature]</i>	<i>[Signature]</i>	<i>[Signature]</i>	<i>[Signature]</i>	<i>[Signature]</i>	<i>[Signature]</i>	<i>[Signature]</i>	<i>[Signature]</i>	<i>[Signature]</i>	<i>[Signature]</i>	<i>[Signature]</i>
TRAINING OFFICER				<i>[Signature]</i>	<i>[Signature]</i>	<i>[Signature]</i>	<i>[Signature]</i>	<i>[Signature]</i>	<i>[Signature]</i>	<i>[Signature]</i>	<i>[Signature]</i>	<i>[Signature]</i>	<i>[Signature]</i>	<i>[Signature]</i>	<i>[Signature]</i>
PRINCIPAL				<i>[Signature]</i>	<i>[Signature]</i>	<i>[Signature]</i>	<i>[Signature]</i>	<i>[Signature]</i>	<i>[Signature]</i>	<i>[Signature]</i>	<i>[Signature]</i>	<i>[Signature]</i>	<i>[Signature]</i>	<i>[Signature]</i>	<i>[Signature]</i>



[Signature]
 PRINCIPAL
 K.S.R. COLLEGE OF ENGINEERING
 K.S.R. KALVI NAGAR,
 TIRUCHENGODE-637 215

K.S.R. COLLEGE OF ENGINEERING (AUTONOMOUS), TIRUCHENGODE - 637 215

TRAINING AND PLACEMENT

AUTO SECOND YEAR (EXTERNAL) APTITUDE & SOFTSKILLS TRAINING ATTENDANCE DETAILS -2024 BATCH

S. No	REG NO	NAME	DATE BRANCH	25.04.2022		26.04.2022		27.04.2022		28.04.2022		29.04.2022		30.04.2022	
				FN	AN	FN	AN	FN	AN	FN	AN	FN	AN	FN	AN
1	2011001	ABISHEK G	AUTO	/	/	/	/	/	/	/	/	/	/	/	/
2	2011007	SANJAY C	AUTO	/	/	/	/	/	/	/	/	/	/	/	/
3	2011008	SATHISHKUMAR V	AUTO	/	/	/	/	/	/	/	/	/	/	/	/
4	2011010	VISHAL K	AUTO	/	/	/	/	/	/	/	/	/	/	/	/
5	2011502	AKASH P	AUTO	/	/	/	/	/	/	/	/	/	/	/	/
6	2011504	BARATH S R	AUTO	/	/	/	/	/	/	/	/	/	/	/	/
7	2011505	DEEPAKRAJ M	AUTO	/	/	/	/	/	/	/	/	/	/	/	/
8	2011506	DEVA PRASANTH G	AUTO	/	/	/	/	/	/	/	/	/	/	/	/
9	2011507	DHINESH S	AUTO	/	/	a	a	/	/	/	/	/	/	/	/
10	2011508	DINESH S	AUTO	/	/	/	/	/	/	/	/	/	/	/	/
11	2011509	GOKULRAM S	AUTO	/	/	/	/	/	/	/	/	/	a	a	/
12	2011511	HARIHASAN M	AUTO	/	/	/	/	/	/	/	/	/	/	/	/
13	2011514	JOTHIVEL V	AUTO	/	/	/	/	/	/	/	/	/	/	/	/
14	2011515	KAVI KUMAR N	AUTO	/	/	/	/	/	/	/	/	/	/	/	/
15	2011516	KAVIN P	AUTO	/	/	/	/	/	/	/	/	/	/	/	/
16	2011518	KISHORE R G	AUTO	/	/	/	/	/	/	/	/	/	/	/	/
17	2011519	MANICKAM V	AUTO	/	/	/	/	/	/	/	/	/	/	/	/
18	2011520	MANOJ C R	AUTO	/	/	/	/	/	/	/	/	/	/	/	/
19	2011521	MUGILARASAN S	AUTO	/	/	/	/	/	/	/	/	/	/	/	/
20	2011523	NAVIEN A P	AUTO	/	/	/	/	/	/	/	/	/	/	/	/
21	2011526	PRAWIN R	AUTO	/	/	/	/	/	/	/	/	/	/	/	/
22	2011529	SANJAY P	AUTO	/	/	/	/	/	/	/	/	/	/	/	/
23	2011531	SATHEESH A	AUTO	/	/	/	/	/	/	/	/	/	/	/	/
24	2011532	SHANMUGAPRIYAN R	AUTO	/	/	/	/	/	/	/	/	/	/	/	/
25	2011533	SOWNDAR RAJAN B	AUTO	/	/	/	/	a	a	/	/	/	/	/	/

PRINCIPAL
K.S.R. COLLEGE OF ENGINEERING
K.S.R. KALVI NAGAR,
TIRUCHENGODE-637 215

26	2011534	SRIRAMKUMAR S	AUTO	/	/	/	/	/	/	/	/	/	/	/	/
27	2011536	VENKATESH K	AUTO	/	/	/	/	/	/	/	/	/	/	/	/
28	2011537	VIGNESH K	AUTO	/	/	/	/	/	/	/	/	/	/	/	/
29	2011538	WILFRED G	AUTO	/	/	/	/	/	/	/	/	/	/	/	/
TOTAL				29	29	29	29	29	29	29	29	29	29	29	29
PRESENT				29	29	28	28	28	28	29	29	29	29	28	28
ABSENT				-	-	01	01	01	01	-	-	-	-	1	1
PLACEMENT CO ORDINATOR SIGN				<i>[Signature]</i>	<i>[Signature]</i>	<i>[Signature]</i>	<i>[Signature]</i>	<i>[Signature]</i>	<i>[Signature]</i>	<i>[Signature]</i>	<i>[Signature]</i>	<i>[Signature]</i>	<i>[Signature]</i>	<i>[Signature]</i>	<i>[Signature]</i>
HOD SIGN				<i>[Signature]</i>	<i>[Signature]</i>	<i>[Signature]</i>	<i>[Signature]</i>	<i>[Signature]</i>	<i>[Signature]</i>	<i>[Signature]</i>	<i>[Signature]</i>	<i>[Signature]</i>	<i>[Signature]</i>	<i>[Signature]</i>	<i>[Signature]</i>
TRAINING OFFICER				<i>[Signature]</i>	<i>[Signature]</i>	<i>[Signature]</i>	<i>[Signature]</i>	<i>[Signature]</i>	<i>[Signature]</i>	<i>[Signature]</i>	<i>[Signature]</i>	<i>[Signature]</i>	<i>[Signature]</i>	<i>[Signature]</i>	<i>[Signature]</i>
PRINCIPAL				<i>[Signature]</i>	<i>[Signature]</i>	<i>[Signature]</i>	<i>[Signature]</i>	<i>[Signature]</i>	<i>[Signature]</i>	<i>[Signature]</i>	<i>[Signature]</i>	<i>[Signature]</i>	<i>[Signature]</i>	<i>[Signature]</i>	<i>[Signature]</i>



[Signature]
 PRINCIPAL
 K.S.R. COLLEGE OF ENGINEERING
 K.S.R. KALVI NAGAR,
 TIRUCHENGODE-637 215.

K.S.R. COLLEGE OF ENGINEERING (AUTONOMOUS), TIRUCHENGODE - 637 215

TRAINING AND PLACEMENT

CIVIL SECOND YEAR (EXTERNAL) APTITUDE & SOFTSKILLS TRAINING ATTENDANCE DETAILS -2024 BATCH

S. No	REG NO	NAME	DATE	25.04.2022		26.04.2022		27.04.2022		28.04.2022		29.04.2022	
			BRANCH	FN	AN	FN	AN	FN	AN	FN	AN	FN	AN
1	2012001	Aravindkumar P	CIVIL	/	/	/	/	/	/	/	/	/	/
2	2012002	Balasarathi J	CIVIL	/	/	/	/	/	/	/	/	/	/
3	2012003	Dhanush R	CIVIL	/	/	/	/	/	/	/	/	/	/
4	2012004	Dheenu K	CIVIL	/	/	/	/	/	/	/	/	/	/
5	2012005	Dineshkumar R	CIVIL	/	/	/	/	/	/	/	/	/	/
6	2012006	Dineshkumar S	CIVIL	/	/	/	/	/	/	/	/	/	/
7	2012007	Gokul S	CIVIL	A	A	A	A	A	A	A	A	A	A
8	2012008	Gurumoorthi M	CIVIL	/	/	/	/	/	/	/	/	/	/
9	2012009	Jayasurya G	CIVIL	/	/	/	/	/	/	/	/	/	/
10	2012010	Kanishk N R	CIVIL	/	/	/	/	/	/	/	/	/	/
11	2012011	Kavin R	CIVIL	/	/	/	/	/	/	/	/	/	/
12	2012012	Kavin Raj K S	CIVIL	/	/	/	/	/	/	/	/	/	/
13	2012013	Kishoth M	CIVIL	/	/	/	/	/	/	/	/	/	/
14	2012015	Mukenth V	CIVIL	/	/	/	/	/	/	/	/	/	/
15	2012016	Mukesh Kumar N	CIVIL	/	/	/	/	/	/	/	/	/	/
16	2012017	Pravinkumar V	CIVIL	/	/	/	/	/	/	/	/	A	A
17	2012018	Santhosh E	CIVIL	/	/	/	/	/	/	/	/	/	/
18	2012019	Santhosh V	CIVIL	/	/	/	/	/	/	/	/	/	/
19	2012020	Srivigneshwar S R	CIVIL	/	/	/	/	/	/	/	/	/	/
20	2012021	Sudharsan J	CIVIL	/	/	/	/	/	/	/	/	/	/
21	2012022	Tamilarasan M	CIVIL	/	/	/	/	A	A	/	/	/	/
22	2012023	Yogesh C	CIVIL	/	/	/	/	/	/	/	/	/	/
23	2012501	Aswin S	CIVIL	/	/	/	/	/	/	/	/	/	/
24	2012502	Bharathraj R	CIVIL	/	/	/	/	/	/	/	/	/	/
25	2012504	Gowrisankar R	CIVIL	/	/	/	/	/	/	/	/	/	/
26	2012505	Jawaharnath T	CIVIL	/	/	/	/	/	/	/	/	/	/
27	2012506	Karan Hembram P	CIVIL	/	/	/	/	/	/	/	/	/	/

PRINCIPAL
 K.S.R. COLLEGE OF ENGINEERING
 K.S.R. KALVI NAGAR,
 TIRUCHENGODE-637 215

28	2012507	Kavin Kumar M D	CIVIL	/	/	/	/	/	/	/	/	/	/
29	2012508	Kishore R	CIVIL	/	/	/	/	/	/	/	/	/	/
30	2012510	Nithesh Kumar S	CIVIL	/	/	/	/	/	/	/	/	/	/
31	2012511	Pradeepkumar V	CIVIL	/	/	/	/	/	/	/	/	/	/
32	2012513	Sakthivel R	CIVIL	/	/	/	/	/	/	/	/	/	/
33	2012514	Sanjay M	CIVIL	/	/	/	/	/	/	/	/	/	/
34	2012515	Santhoshkumar M	CIVIL	/	/	/	/	/	/	/	/	/	/
35	2012516	Sathish Kumar A	CIVIL	/	/	/	/	/	/	/	/	/	/
36	2012517	Sattar M	CIVIL	/	/	/	/	/	/	/	/	/	/
37	2012518	Subash Chandra Bose P	CIVIL	/	/	/	/	A	A	A	A	A	A
38	2012520	Sugan R	CIVIL	/	/	/	/	/	/	/	/	/	/
39	2012522	Thangamuthu M	CIVIL	/	/	/	/	/	/	/	/	/	/
40	2012523	Vikash A	CIVIL	/	/	/	/	A	A	/	/	/	/
41	2012524	Yaswin M K	CIVIL	/	/	/	/	/	/	/	/	/	/
TOTAL				41	41	41	41	41	41	41	41	41	41
PRESENT				40	40	40	40	37	37	39	39	38	38
ABSENT				1	1	1	1	4	4	2	2	3	3
PLACEMENT CO ORDINATOR SIGN				<i>[Signature]</i>	<i>[Signature]</i>	<i>[Signature]</i>	<i>[Signature]</i>	<i>[Signature]</i>	<i>[Signature]</i>	<i>[Signature]</i>	<i>[Signature]</i>	<i>[Signature]</i>	<i>[Signature]</i>
HOD SIGN				<i>[Signature]</i>	<i>[Signature]</i>	<i>[Signature]</i>	<i>[Signature]</i>	<i>[Signature]</i>	<i>[Signature]</i>	<i>[Signature]</i>	<i>[Signature]</i>	<i>[Signature]</i>	<i>[Signature]</i>
TRAINING OFFICER				<i>[Signature]</i>	<i>[Signature]</i>	<i>[Signature]</i>	<i>[Signature]</i>	<i>[Signature]</i>	<i>[Signature]</i>	<i>[Signature]</i>	<i>[Signature]</i>	<i>[Signature]</i>	<i>[Signature]</i>
PRINCIPAL				<i>[Signature]</i>	<i>[Signature]</i>	<i>[Signature]</i>	<i>[Signature]</i>	<i>[Signature]</i>	<i>[Signature]</i>	<i>[Signature]</i>	<i>[Signature]</i>	<i>[Signature]</i>	<i>[Signature]</i>



PRINCIPAL
K.S.R. COLLEGE OF ENGINEERING
K.S.R. KALVI NAGAR,
TIRUCHENGODE-637 015.

K.S.R. COLLEGE OF ENGINEERING (AUTONOMOUS), TIRUCHENGAI - 637 215

TRAINING AND PLACEMENT

ECE SECOND YEAR (EXTERNAL) APTITUDE & SOFTSKILLS TRAINING ATTENDANCE DETAILS -2024 BATCH

S. No	REG NO	NAME	DATE	25.04.2022		26.04.2022		27.04.2022		28.04.2022		29.04.2022		30.04.2022	
			BRANCH	FN	AN	FN	AN	FN	AN	FN	AN	FN	AN	FN	AN
1	2015001	ANANDHA PRAKASH R	ECE	/	/	/	/	/	/	/	/	/	/		
2	2015002	BALAJI S	ECE	/	/	/	/	/	/	/	/	/	/		
3	2015003	DHANRAAJ S	ECE	/	/	/	/	/	/	/	/	/	/		
4	2015004	GIRIDHARAN P	ECE	/	/	/	/	/	/	/	/	/	/		
5	2015005	GOKUL K	ECF	/	/	/	/	/	/	/	/	/	/		
6	2015006	GOWTHAM M	ECF	/	/	/	/	/	/	/	/	/	/		
7	2015007	HARIISH R S	ECE	/	/	/	/	/	/	/	/	/	/		
8	2015008	HARISH V	ECE	/	/	/	/	/	/	/	/	/	/		
9	2015009	HEMANTH KUMAR M	ECE	/	/	/	/	/	/	/	/	/	/		
10	2015010	JAICHANDRU S	ECF	/	/	/	/	/	/	/	/	/	/		
11	2015011	JAYAPRAKASH R	ECF	/	/	/	/	/	/	/	/	/	/		
12	2015012	JAYAPRAVINRAI R	ECF	/	/	/	/	/	/	/	/	/	/		
13	2015013	JEVA R	ECE	/	/	/	/	/	/	/	/	/	/		
14	2015014	JEEVANANTHAM P	ECE	/	/	/	/	/	/	/	/	/	/		
15	2015015	JEEVANANTHAM P	ECE	/	/	/	/	/	/	/	/	/	/		
16	2015016	JINLI R	ECF	/	/	/	/	/	/	/	/	/	/		
17	2015017	KAMALFSHKANNA P	ECE	/	/	/	/	/	/	/	/	/	/		
18	2015018	KARTHICK RAJA P	ECE	/	/	/	/	/	/	/	/	/	/		
19	2015019	KARTHIGADEVI T	ECE	/	/	/	/	/	/	/	/	/	/		
20	2015020	KATHIRVEL R	ECE	/	/	/	/	/	/	/	/	/	/		
21	2015021	KIRLUTHIKA D	ECF	/	/	/	/	/	/	/	/	/	/		
22	2015022	LOGESH S	ECE	/	/	/	/	/	/	/	/	/	/		
23	2015023	MAHAA SHURUTHY G	ECE	/	/	/	/	/	/	/	/	/	/		
24	2015025	MANOBALA S	ECE	/	/	/	/	/	/	/	/	/	/		
25	2015026	MOHANA PRASATH K	ECE	A	A	A	A	A	A	A	A	A	A		
26	2015027	MOHANKUMAR GV	ECE	/	/	/	/	/	/	/	/	/	/		
27	2015028	NAVACHITHU PONKUMAR D	ECE	/	/	/	/	/	/	/	/	/	/		
28	2015029	PANDISELVI P	ECE	/	/	/	/	/	/	/	/	/	/		
29	2015030	PERIYASAMY S	ECE	/	/	/	/	/	/	/	/	/	/		
30	2015031	PRADEEP R	ECE	/	/	/	/	/	/	/	/	/	/		

Edi's writing

31	2015032	PRAVEENKUMAR R	ECE	/	/	/	/	/	/	/	/	/	/	/		
32	2015501	AJITHKUMAR S	ECE	/	/	/	/	/	/	/	/	/	/	/		
33	2015502	BALAJI M	ECE	/	/	/	/	/	/	/	/	/	/	/		
34	2015503	DHARANIDHARAN B	ECE	/	/	/	/	/	/	/	/	/	/	/		
35	2015504	GOKULRAM S	ECE	/	/	/	/	/	/	/	/	/	/	/		
36	2015505	HARIRAJ R	ECE	/	/	/	/	/	/	/	/	/	/	/		
37	2015506	JAGAN S (09/09/2000) (E)	ECE	/	/	/	/	/	/	/	/	/	/	/		
38	2015507	JAGAN S (09/06/2001) (R)	ECE	/	/	/	/	/	/	/	/	/	/	/		
39	2015508	JAWAHAR M	ECE	/	/	/	/	/	/	/	/	/	/	/		
40	2015509	JAYANTH S	ECE	/	/	A	A	/	/	/	/	/	/	/		
41	2015510	JAYASURYA A	ECE	/	/	/	/	/	/	/	/	/	/	/		
42	2015511	JEEVA P	ECE	/	/	/	/	/	/	/	/	/	/	/		
43	2015512	JEGANATH T	ECE	/	/	/	/	/	/	/	/	/	/	/		
44	2015513	KARTHICK S (24/11/1999) (D)	ECE	/	/	/	/	/	/	/	/	/	/	/		
45	2015515	LOGA DEEPAK K U	ECE	/	/	/	/	/	/	/	/	/	/	/		
46	2015517	MANIKANDAN P	ECE	/	/	/	/	/	/	/	/	/	/	/		
47	2015033	PRAVEENKUMAR R	ECE	/	/	/	/	/	/	/	/	/	/	/		
48	2015034	PUGAZHENTHI V	ECE	/	/	/	/	/	/	/	/	/	/	/		
49	2015035	RAJA SRI B	ECE	/	/	/	/	/	/	/	/	/	/	/		
50	2015036	RAMYA S S	ECE	/	/	/	/	/	/	/	/	/	/	/		
51	2015037	RISHIKESAN R	ECE	/	/	/	/	/	/	/	/	/	/	/		
52	2015038	SABARI S	ECE	/	/	/	/	/	/	/	/	/	/	/		
53	2015039	SANGAVI S	ECE	/	/	/	/	/	/	/	/	/	/	/		
54	2015040	SANJAY L	ECE	/	/	/	/	/	/	/	/	/	/	/		
55	2015041	SANTHIYA N	ECE	/	/	/	/	/	/	/	A	A	/	/		
56	2015042	SANTHOSH K	ECE	/	/	/	/	/	/	/	/	/	/	/		
57	2015043	SARAN C	ECE	/	/	/	/	/	/	/	/	/	/	/		
58	2015044	SARAVANAN R	ECE	/	/	/	/	/	/	/	/	/	/	/		
59	2015045	SHAMINI RAJA SALAMI S	ECE	A	A	A	A	A	A	A	A	A	A	A		
60	2015046	SHANJEVI M	ECE	/	/	/	/	/	/	/	/	/	/	/		
61	2015047	SIVAKUMAR M	ECE	A	A	/	/	/	/	/	/	/	/	/		
62	2015048	SNEKA GP	ECE	/	/	/	/	/	/	A	A	/	/	/		
63	2015049	SRI KOWSIKA V	ECE	/	/	/	/	/	/	/	/	/	/	/		
64	2015050	SRI SABHARISH S	ECE	/	/	/	/	/	/	/	/	/	/	/		
65	2015051	SRIDHARAN J	ECE	/	/	/	/	/	/	/	/	/	/	/		
66	2015052	SRIVIDHYA A	ECE	/	/	/	/	/	/	/	/	/	/	/		

(Father's Name)

67	2015053	SUBASH M	ECE	/	/	/	/	/	/	/	/	/	/	/	/	
68	2015054	SUDHAKAR S	ECE	/	/	/	/	/	/	/	/	/	/	/	/	
69	2015055	SUDHAKAR N	ECE	/	/	/	/	/	/	/	/	/	/	/	/	
70	2015056	SUDHARSAN R	ECE	/	/	/	/	/	/	/	/	/	/	/	/	
71	2015057	SURIYA P	ECE	/	/	/	/	/	/	/	/	/	/	/	/	
72	2015058	SURUTHI K	ECE	/	/	/	/	/	/	/	/	/	/	/	/	
73	2015059	SURYA V	ECE	/	/	/	/	/	/	/	/	/	/	/	/	
74	2015060	SUVITHA M	ECE	/	/	/	/	/	/	/	/	/	/	/	/	
75	2015061	VAISHNAVI M	ECE	/	/	/	/	/	/	/	/	/	/	/	/	
76	2015062	VAISHNAVI V	ECE	/	/	/	/	/	/	/	/	/	/	/	/	
77	2015063	VIGNESH A	ECE	A	A	A	A	A	A	A	A	A	A	A	A	
78	2015516	LOGESH P	ECE	/	/	/	/	/	/	/	/	/	/	/	/	
79	2015518	MANJU R	ECE	/	/	/	/	/	/	/	/	/	/	/	/	
80	2015519	MATHIYAZHAGAN D	ECE	/	/	/	/	/	/	A	A	/	/	/	/	
81	2015520	MUGUNTHAN R	ECE	/	/	/	/	/	/	/	/	/	/	/	/	
82	2015520	MUKUNTHAN M	ECE	/	/	/	/	/	/	/	/	/	/	/	/	
83	2015522	NARESH KUMAR S	ECE	/	/	/	/	/	/	/	/	/	A	A	A	
84	2015523	NAVFFNKUMAR S	ECE	/	/	/	/	/	/	/	/	/	/	/	/	
85	2015524	POOVARASAN C	ECE	/	/	/	/	/	/	/	/	/	/	/	/	
86	2015525	PRADEEP KUMAR M	ECE	/	/	/	/	/	/	/	/	/	/	/	/	
87	2015526	PRANESH S	ECE	/	/	/	/	/	/	/	/	/	/	/	/	
88	2015527	PRASAD T	ECE	/	/	/	/	/	/	/	/	/	/	/	/	
89	2015528	RANJITH G	ECE	/	/	/	/	/	/	/	/	/	/	/	/	
90	2015529	SAKTHI R	ECE	/	/	/	/	/	/	/	/	/	/	/	/	
91	2015530	SATHISHKUMAR G	ECE	/	/	/	/	/	/	/	/	/	/	/	/	
92	2015531	SUBASH M	ECE	/	/	/	/	/	/	/	/	/	/	/	/	
93	2015532	YASUDHIN U	ECE	/	/	/	/	/	/	/	/	/	/	/	/	
TOTAL				93	93	93	93	93	95	93	96	93	93	93	93	93
PRESENT				89	89	89	89	90	90	87	87	89	89	89	89	89
ABSENT				4	4	4	4	3	3	6	6	4	4	4	4	4
PLACEMENT CO ORDINATOR SIGN																
HOD SIGN																
TRAINING OFFICER																
PRINCIPAL																

Month
(operation)

K.S.R. COLLEGE OF ENGINEERING (AUTONOMOUS), TIRUCHENGODE - 637 215

TRAINING AND PLACEMENT

EEE SECOND YEAR (EXTERNAL) APTITUDE & SOFTSKILLS TRAINING ATTENDANCE DETAILS -2024 BATCH

S. No	REG NO	NAME	DATE	25.04.2022		26.04.2022		27.04.2022		28.04.2022		29.04.2022		30.04.2022	
			BRANCH	FN	AN	FN	AN	FN	AN	FN	AN	FN	AN	FN	AN
1	2014001	AJAYKUMAR M	EEE	/	/	/	/	/	/	/	/	/	/		
2	2014002	AKSHAYAA S	EEE	/	/	/	/	/	/	/	/	/	/		
3	2014003	ARAVINDH R	EEE	/	/	/	/	/	/	/	/	/	/		
4	2014004	ASHOK KUMAR S	EEE	/	/	/	/	/	/	/	/	/	/		
5	2014005	BALASURYA J	EEE	/	/	/	/	/	/	/	/	/	/		
6	2014006	DHAKSHAYANE THARENE MKS	EEE	/	/	/	/	/	/	/	/	/	/		
7	2014007	DHAMODHARAN M	EEE	/	/	/	/	/	/	/	/	/	/		
8	2014008	DHANISH M	EEE	/	/	/	/	/	/	/	/	/	/		
9	2014009	DHANUSH R	EEE	/	/	/	/	/	/	/	/	A	A		
10	2014011	DIVAGAR C	EEE	/	/	/	/	/	/	/	/	/	/		
11	2014012	ESWARARUNPRAKASH J K	EEE	/	/	/	/	/	/	/	/	/	/		
12	2014014	KARTHIK G	EEE	/	/	/	/	A	A	A	A	A	A		
13	2014015	KAVIYA R	EEE	/	/	/	/	/	/	/	/	/	/		
14	2014018	MEGANATHAN.C	EEE	/	/	/	/	/	/	/	/	/	/		
15	2014019	MOHANAKUMAR N S	EEE	/	/	/	/	/	/	/	/	/	/		
16	2014020	MONITHKUMAR B	EEE	/	/	/	/	/	/	/	/	/	/		
17	2014021	NAVANEETHA KRISHNAN S	EEE	/	/	/	/	/	/	/	/	/	/		
18	2014022	NAVEEN T	EEE	/	/	/	/	/	/	/	/	/	/		
19	2014023	NAVEEN KUMAR V	EEE	/	/	A	A	/	/	/	/	/	/		
20	2014025	PERIYANARAYANAN S	EEE	/	/	/	/	/	/	/	/	/	/		
21	2014026	PREETHI C	EEE	/	/	/	/	/	/	/	/	/	/		
22	2014027	RAGAVAN S	EEE	/	/	/	/	/	/	/	/	/	/		
23	2014028	RAGUL A K	EEE	/	/	/	/	/	/	/	/	/	/		
24	2014029	RAMANITHARAN K S	EEE	/	/	/	/	/	/	/	/	/	/		
25	2014030	SABARINATHAN K	EEE	/	/	/	/	/	/	/	/	/	/		
26	2014032	SATHISH P S	EEE	/	/	/	/	/	/	/	/	/	/		
27	2014033	SATHISHKUMAR P	EEE	/	/	/	/	/	/	/	/	/	/		



PRINCIPAL
K.S.R. COLLEGE OF ENGINEERING
K.S.R. KALVI NAGAR,
TIRUCHENGODE-637 215

28	2014034	SEETHALAKSHMI V	EEE	/	/	/	/	/	/	/	/	/	/			
29	2014035	SHAM ARNOLD S	EEE	/	/	/	/	/	/	/	/	/	/			
30	2014036	SHRUTHI G	EEE	/	/	/	/	/	/	/	/	/	/			
31	2014037	SIBIRAJ B	EEE	/	/	/	/	/	/	/	/	/	/			
32	2014038	SRINITHIN V M	EEE	/	/	/	/	/	/	/	/	X	/			
33	2014039	SRIRAM S	EEE	/	/	/	/	/	/	/	/	/	/			
34	2014041	SUJEET K	EEE	A	A	A	A	/	/	/	/	/	/			
35	2014042	VENGATESH K	EEE	/	/	/	/	/	/	/	/	/	/			
36	2014044	VIMALAN V	EEE	/	/	/	/	/	/	/	/	/	/			
37	2014501	ANEESH P	EEE	/	/	/	/	/	/	/	/	/	/			
38	2014504	DHANUSHKUMAR A	EEE	/	/	/	/	/	/	/	/	/	/			
39	2014510	NAVEENKUMAR V	EEE	/	/	/	/	/	/	/	/	/	/			
40	2014513	RUBANKUMAR K	EEE	/	/	/	/	/	/	/	/	/	/			
41	2014515	SADHEESH S	EEE	/	/	/	/	A	A	A	A	/	/			
42	2014516	SANDEEP RAJ K	EEE	/	/	/	/	/	/	/	/	/	/			
43	2014519	SUDHAKARAN S	EEE	/	/	/	/	/	/	/	/	/	/			
44	2014523	YUVARAJ S	EEE	/	/	/	/	/	/	/	/	/	/			
TOTAL				44	44	44	44	44	44	44	44	44	44	44		
PRESENT				43	43	42	42	42	42	42	42	42	42	42		
ABSENT				01	01	02	02	02	02	02	02	02	02	02		
PLACEMENT CO ORDINATOR SIGN				<i>[Signature]</i>	<i>[Signature]</i>	<i>[Signature]</i>	<i>[Signature]</i>	<i>[Signature]</i>	<i>[Signature]</i>	<i>[Signature]</i>	<i>[Signature]</i>	<i>[Signature]</i>	<i>[Signature]</i>	<i>[Signature]</i>		
HOD SIGN				<i>[Signature]</i>	<i>[Signature]</i>	<i>[Signature]</i>	<i>[Signature]</i>	<i>[Signature]</i>	<i>[Signature]</i>	<i>[Signature]</i>	<i>[Signature]</i>	<i>[Signature]</i>	<i>[Signature]</i>	<i>[Signature]</i>		
TRAINING OFFICER				<i>[Signature]</i>	<i>[Signature]</i>	<i>[Signature]</i>	<i>[Signature]</i>	<i>[Signature]</i>	<i>[Signature]</i>	<i>[Signature]</i>	<i>[Signature]</i>	<i>[Signature]</i>	<i>[Signature]</i>	<i>[Signature]</i>		
PRINCIPAL				<i>[Signature]</i>	<i>[Signature]</i>	<i>[Signature]</i>	<i>[Signature]</i>	<i>[Signature]</i>	<i>[Signature]</i>	<i>[Signature]</i>	<i>[Signature]</i>	<i>[Signature]</i>	<i>[Signature]</i>	<i>[Signature]</i>		

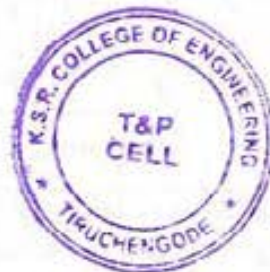

PRINCIPAL
K.S.R. COLLEGE OF ENGINEERING
K.S.R. KALVI NAGAR,
TIRUCHENGODE-637 215,

33	2021037	PRASANTH.N	IT	/	/	/	/	/	/	/	/	/	/			
34	2021038	PRAVEENKUMAR.V*	IT	/	/	/	/	/	/	/	/	/	/			
35	2021039	PRAVINKUMAR.M	IT	/	/	/	/	/	/	/	/	/	/			
36	2021040	PRIYANKA.P	IT	/	/	/	/	/	/	/	/	/	/			
37	2021041	RAVISANKAR.G	IT	/	/	/	/	/	/	/	/	/	/			
38	2021042	RITTHISH.R.V	IT	/	/	/	/	/	/	/	/	/	/			
39	2021043	SANJAY.J	IT	/	/	/	/	/	/	/	/	/	/			
40	2021044	SANTHOSH.A	IT	/	/	/	/	/	/	/	/	/	/			
41	2021045	SATHISH.A	IT	/	/	/	/	/	/	/	/	/	/			
42	2021047	SHARVESH.M	IT	/	/	/	/	/	/	/	/	2	2			
43	2021048	SHEVAKSRI.P	IT	/	/	/	/	/	/	/	/	/	/			
44	2021049	SRITHAR.S.V	IT	/	/	/	/	/	/	/	/	/	/			
45	2021050	SUGANESH.G	IT	/	/	/	/	/	/	/	/	/	/			
46	2021051	SURRIYAA.P.P	IT	/	/	/	/	/	/	/	/	/	/			
47	2021052	SUWETHAA.M.K	IT	/	/	/	/	/	/	/	/	/	/			
48	2021053	TAMILZHARASU.M.P	IT	/	/	/	/	/	/	/	/	/	/			
49	2021054	VASANTH.P	IT	/	/	/	/	/	/	/	/	/	/			
50	2021055	VASANTH.V	IT	/	/	/	/	/	/	/	/	/	/			
51	2021056	VASUDEVAN.R	IT	/	/	/	/	/	/	/	/	2	2			
52	2021057	VIGNESH.S	IT	/	/	/	/	/	/	/	/	/	/			
53	2021058	VIGNESH.C	IT	/	/	/	/	/	/	/	/	/	/			
54	2021059	VIMALAA SRI.V.S	IT	/	/	2	2	/	/	/	/	/	/			
55	2021060	YUVASREE.S	IT	/	/	/	/	/	/	/	/	/	/			
56	20LIT001	ESWAR CHANDAR. P	IT	/	/	/	/	/	/	2	2	12	1			
57	20LIT002	GOWTHAMAN .S	IT	/	/	/	/	/	/	/	/	/	/			
58	20LIT004	PRAKASH .K	IT	/	/	/	/	/	/	/	/	12	1			
59	20LIT005	SIVABALAN. G	IT	/	/	/	/	/	/	/	/	2	2			
60	20LIT006	VIDHYASRI. G	IT	/	/	/	/	/	/	/	/	12	1			
TOTAL				60	60	60	60	60	60	60	60	60	60	60		
PRESENT				59	59	59	59	58	58	59	59	54	54			
ABSENT				1	1	1	1	02	2	1	1	6	6			
PLACEMENT CO ORDINATOR SIGN				/	/	/	/	/	/	/	/	/	/			
HOD SIGN				/	/	/	/	/	/	/	/	/	/			
TRAINING OFFICER				/	/	/	/	/	/	/	/	/	/			
PRINCIPAL				/	/	/	/	/	/	/	/	/	/			

leave

PRINCIPAL
K.S.R. COLLEGE OF ENGINEERING
K.S.R. KALVI NAGAR,
TIRUCHENGODE-637

IT SECOND YEAR (EXTERNAL) ATTITUDE & SOFTSKILLS TRAINING ATTENDANCE DETAILS - 2024 BATCH

S. No	REG NO	NAME	DATE	25.04.2022		26.04.2022		27.04.2022		28.04.2022		29.04.2022		30.04.2022	
			BRANCH	FN	AN	FN	AN	FN	AN	FN	AN	FN	AN	FN	AN
1	2021001	ABISHEK.U	IT	/	/	/	/	/	/	/	/	/	/		
2	2021002	ABISHEK.R.S	IT	/	/	/	/	/	/	/	/	/	/		
3	2021003	BALAJI.M	IT	/	/	/	/	/	/	/	/	/	/		
4	2021004	BATSHA. T	IT	a	a	c	/	/	/	/	/	a	a		
5	2021005	BHARATHI.P	IT	/	/	/	/	/	/	/	/	/	/		
6	2021006	BHASKARAPRASATH.S.K	IT	/	/	/	/	A	A	/	/	/	/		
7	2021007	BHUVANESH.G	IT	/	/	/	/	/	/	/	/	/	/		
8	2021008	DHANUSHYA.K	IT	/	/	/	/	/	/	/	/	/	/		
9	2021009	DIVYA.K	IT	/	/	/	/	/	/	/	/	/	/		
10	2021011	FARITHA BANU.M	IT	/	/	/	/	/	/	/	/	/	/		
11	2021012	GIRIJA.V	IT	/	/	/	/	/	/	/	/	/	/		
12	2021014	GOBIKA.C	IT	/	/	/	/	/	/	/	/	/	/		
13	2021015	GOKUL.R	IT	/	/	/	/	/	/	/	/	/	/		
14	2021017	GOPI.M	IT	/	/	/	/	/	/	/	/	/	/		
15	2021018	GOPINATH.N	IT	/	/	/	/	/	/	/	/	/	/		
16	2021019	HARIPRASATH.S	IT	/	/	/	/	/	/	/	/	/	/		
17	2021020	HARIPRIYA.G	IT	/	/	/	/	/	/	/	/	/	/		
18	2021021	KALPANA.V	IT	/	/	/	/	/	/	/	/	/	/		
19	2021022	KANISHKA.V	IT	/	/	/	/	/	/	/	/	/	/		
20	2021023	KAVIN.S	IT	/	/	/	/	/	/	/	/	/	/		
21	2021024	KAVIN KUMAR.R	IT	/	/	/	/	/	/	/	/	/	/		
22	2021025	KISHORE.B	IT	/	/	/	/	/	/	/	/	/	/		
23	2021026	LALITH KUMAR.R	IT	/	/	/	/	/	/	/	/	/	/		
24	2021027	LOGA MOORTHY.S	IT	/	/	/	/	/	/	/	/	a	a		
25	2021028	MANIBHARATHI.J	IT	/	/	/	/	/	/	/	/	/	/		
26	2021029	MANIKANDAN.S	IT	/	/	/	/	A	A	/	/	10	/		
27	2021030	MITHRA.S.P	IT	/	/	/	/	/	/	/	/	/	/		
28	2021031	MOHAMEDFAHEEM.S	IT	/	/	/	/	/	/	/	/	a	a		
29	2021032	MOHAN.G	IT	/	/	/	/	/	/	/	/	/	/		
30	2021034	PAVITHRA.S	IT	/	/	/	/	/	/	/	/	/	/		
31	2021035	POOVARASAN.G	IT	/	/	/	/	/	/	/	/	/	/		
32	2021036	POOVARASAN.G	IT	/	/	/	/	/	/	/	/	/	/		

leave

30	2016506	Ashok Kumar.M	MECH	/	/	/	/	/	/	/	/	/	/	/		
31	2016509	CHANDRU N	MECH	/	/	/	/	/	/	/	/	/	/	/		
32	2016510	CHITHIRAISELVAN S	MECH	/	/	/	/	/	/	/	/	/	/	/		
33	2016511	Darshan.J	MECH	/	/	/	/	/	/	/	/	/	/	/		
34	2016513	DEVENDRAN SRIKANT GANESHAN	MECH	/	/	/	/	/	/	/	/	/	/	/		
35	2016514	DHAMODHARAN B	MECH	/	/	/	/	/	/	/	/	/	/	/		
36	2016515	DHAMOTHIRAN S	MECH	/	/	a	a	a	a	/	/	/	/	/		
37	2016517	DINAKAR M	MECH	/	/	/	/	/	/	/	/	/	/	/		
38	2016518	DINAKAR M M	MECH	/	/	/	/	/	/	/	/	/	/	/		
39	2016520	DIVVIYAN S	MECH	/	/	/	/	/	/	/	/	/	/	/		
40	2016521	GOBINATH P [PANDIDURAI]	MECH	/	/	/	/	/	/	/	/	/	/	/		
41	2016523	GODWIN G	MECH	/	/	/	/	/	/	/	/	/	/	/		
42	2016524	GOKUL US	MECH	/	/	/	/	/	/	/	/	/	/	/		
43	2016525	GOWTHAM T [THANGAVEL]	MECH	/	/	/	/	/	/	/	/	/	/	/		
44	2016527	HARIHARAN V	MECH	/	/	/	/	/	/	/	/	/	/	/		
45	2016531	JAKATHESAN T	MECH	/	/	/	/	/	/	/	/	/	/	/		
46	2016532	JAVAHAR R V	MECH	/	/	/	/	/	/	/	/	/	/	/		
47	2016533	JAYANTH S [DEVI]	MECH	/	/	/	/	/	/	/	/	/	/	/		
48	2016536	KARTHIKEYAN E	MECH	/	/	/	/	/	/	/	/	/	/	/		
49	2016537	KAVIN R	MECH	/	/	/	/	/	/	/	/	/	/	/		
50	2016538	KAVIN S	MECH	/	/	/	/	/	/	/	/	/	/	/		
51	2016540	KEERTHIVASAN	MECH	/	/	/	/	/	/	/	/	/	/	/		
52	2016541	KIRUBAKARAN M	MECH	/	/	/	/	/	/	/	/	/	/	/		
53	2016542	KOWSHICK C	MECH	/	/	/	/	/	/	/	a	a	/	/		
54	2016545	MANIKANDAN M	MECH	/	/	/	/	/	/	/	/	/	/	/		
55	2016546	MANOJ S	MECH	/	/	/	/	/	/	/	/	/	/	/		
56	2016548	MOHAN KUMAR B	MECH	/	/	/	/	/	/	/	/	/	/	/		
57	2016551	MONISH N	MECH	/	/	/	/	/	/	/	/	/	/	/		
58	2016552	MOTHILKUMAR M	MECH	/	/	/	/	/	/	/	/	/	/	/		
59	2016554	MUKILAN M	MECH	/	/	/	/	/	/	/	/	/	/	/		
60	2016555	NAVEEN A	MECH	/	/	/	/	/	/	/	/	/	/	/		
61	2016557	NAVEEN G	MECH	/	/	/	/	a	/	a	a	/	/	/		
62	2016558	NAVEEN R	MECH	/	/	/	/	/	/	/	/	/	/	/		
63	2016559	NAVEENKUMAR J R	MECH	/	/	/	/	a	/	/	/	/	/	/		
64	2016560	NAVEEN KUMAR T	MECH	/	/	/	/	/	/	/	/	/	/	/		

1
32
41
2
85

65	2016564	NIVASH A	MECH	/	/	/	/	/	/	/	/	/	/	/	/	/	/	
66	2016565	PALANIVEL M	MECH	/	/	a	/	/	/	/	/	/	/	/	/	/	/	
67	2016566	PANJU ARUNACHALAM K	MECH	/	/	/	/	/	/	/	/	/	/	/	/	/	/	
68	2016567	PEER MOHAMED A	MECH	/	/	/	/	/	/	/	/	/	/	/	/	/	/	
69	2016570	PRAVEEN M	MECH	/	/	/	/	/	/	/	/	/	/	/	/	/	/	
70	2016572	PRVEENKUMAR K	MECH	/	/	/	/	/	/	/	/	/	/	/	/	/	/	
71	2016574	PUGAZHENDHI D	MECH	/	/	/	/	/	/	/	/	/	/	/	/	/	/	
72	2016575	RAGULRAJ S R.	MECH	/	/	/	/	/	/	/	/	/	/	/	/	/	/	
73	2016576	RAGULKUMAR G	MECH	/	/	/	/	/	/	/	/	/	/	/	/	/	/	
74	2016577	RAJA VIGNESH C	MECH	/	/	a	/	/	/	/	/	/	/	/	/	/	/	
75	2016580	SACHIN L K	MECH	/	/	/	/	/	/	/	/	/	/	/	/	/	/	
76	2016581	SANTHOSH A	MECH	/	/	/	/	/	/	/	/	/	/	/	/	/	/	
77	2016582	SARAN R	MECH	/	/	/	/	/	/	/	/	/	/	/	/	/	/	
78	2016584	SATHISH M	MECH	/	/	/	/	/	/	/	/	/	/	/	/	/	/	
79	2016585	SIVANES N T	MECH	/	/	/	/	/	/	/	/	/	/	/	/	/	/	
80	2016586	SIVASAKTHI L S	MECH	/	/	/	/	/	/	/	/	/	/	/	/	/	/	
81	2016588	SOWNDHAR M	MECH	/	/	a	/	/	/	/	/	/	/	/	/	/	/	
82	2016589	SREE BALAJI T	MECH	/	/	/	/	/	/	/	/	/	/	/	/	/	/	
83	2016590	SRIHARAN B	MECH	/	/	/	/	/	/	/	/	/	/	/	/	/	/	
84	2016591	SRIMURUGAN S	MECH	/	/	/	/	/	/	/	/	/	/	/	/	/	/	
85	2016592	SRIRAMAJAYAM G	MECH	/	/	/	/	/	/	/	/	/	/	/	/	/	/	
86	2016593	SUDHARSAN M	MECH	/	/	/	/	/	/	/	/	/	/	/	/	/	/	
87	2016596	TAMILSELVAN S	MECH	/	/	/	/	/	/	/	/	/	/	/	/	/	/	
88	2016597	UMAIYORUBAGAN T V	MECH	/	/	/	/	/	/	/	/	/	/	/	/	/	/	
TOTAL				88	88	83	88	88	88	88	88	88	88	88	88	88	88	88
PRESENT				88	88	84	88	85	85	85	85	88	88	88	88	88	88	88
ABSENT				-	-	4	4	3	3	3	3	-	-	-	-	-	-	-
PLACEMENT CO ORDINATOR SIGN				/	/	/	/	/	/	/	/	/	/	/	/	/	/	/
HOD SIGN				/	/	/	/	/	/	/	/	/	/	/	/	/	/	/
TRAINING OFFICER				/	/	/	/	/	/	/	/	/	/	/	/	/	/	/
PRINCIPAL				/	/	/	/	/	/	/	/	/	/	/	/	/	/	/

33

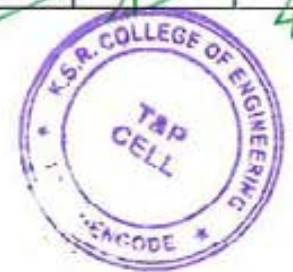

PRINCIPAL
K.S.R. COLLEGE OF ENGINEERING
K.S.R. KALVI NAGAR,
TIRUCHENGODE-637 215

K.S.R. COLLEGE OF ENGINEERING (AUTONOMOUS), TIRUCHENGODE - 637 215

TRAINING AND PLACEMENT

SFE SECOND YEAR (EXTERNAL) APTITUDE & SOFTSKILLS TRAINING ATTENDANCE DETAILS -2024 BATCH

S. No	REG NO	NAME	DATE	25.04.2022		26.04.2022		27.04.2022		28.04.2022		29.04.2022		30.04.2022	
			BRANCH	FN	AN	FN	AN	FN	AN	FN	AN	FN	AN	FN	AN
1	2017501	AKASH R	SFE	/	/	/	/			/	/	/	/		
2	2017517	GOVINDARAJ R	SFE	/	/	/	/			/	/	/	/		
3	2017519	S.JAYAPRAKASH	SFE	/	/	/	/			/	/	/	/		
4	2017528	NAVEEN.P	SFE	/	/	/	/			/	/	/	/		
5	2017522	MADHAN KUMAR S	SFE	/	/	/	/			/	/	/	/		
6	2017540	SIVAKUMAR A	SFE	/	/	/	/			/	/	/	/		
7	2017508	DEEPAK.R	SFE	/	/	/	/			/	/	/	/		
8	2017538	SATHYAMOORTHY K	SFE	/	/	/	/			/	/	/	/		
9	2017002	DHANUSH KUMAR.T	SFE	/	/	/	/			/	/	/	/		
10	2017523	Marish v	SFE	/	/	/	/			/	/	/	/		
11	2017001	DHANUSH. K	SFE	/	/	/	/			/	/	/	/		
12	2017004	NITHISH KUMAR. P	SFE	/	/	/	/			/	/	/	/		
13	2017542	SUDHAN.P	SFE	/	/	/	/			/	/	/	/		
14	2017007	SAKTHIVEL M	SFE	/	/	/	/			/	/	/	/		
15	2017516	S GOKULRAJ	SFE	/	/	/	/			/	/	/	/		
16	2017536	S.SARANRAJ	SFE	/	/	/	/			/	/	/	/		
17	2017003	GUNASEKARAN S	SFE	/	/	/	/			/	/	/	/		
18	2017010	SURIYAPRASANTH N	SFE	/	/	/	/			/	/	/	/		
19	2017520	JOTHIKRISHNAN T	SFE	/	/	/	/			/	/	/	/		
20	2017009	SUDHAKARAN R	SFE	/	/	/	/			/	/	/	/		
21	2817533	RAGUL P	SFE	/	/	/	/			/	/	/	/		
22	2017503	R. S ARJUN ADHITHYA	SFE	/	/	/	/			/	/	/	/		
23	2017006	PREMKUMAR. B	SFE	/	/	/	/			/	/	/	/		
24	2017534	ROHITH RAJAN R	SFE	/	/	/	/			/	/	/	/		
25	2017507	K.BARATH KAVINASH	SFE	/	/	/	/			/	/	/	/		

 PRINCIPAL,
 K.S.R. COLLEGE OF ENGINEERING
 K.S.R. KALVI NAGAR,
 TIRUCHENGODE-637 215

				25/4		26/4		28/4							
26	2017504	K.BALACHANDER	SFE	/	/	/	/	/	/	/	/	/	/	/	/
27	2017537	SARVESH KUMAR RK	SFE	/	/	/	/	/	/	/	/	/	/	/	/
28	2017008	SHREEDAR.P	SFE	/	/	/	/	/	/	/	/	/	/	/	/
29	2017514	ELAMBHARUTHI C	SFE	/	/	/	/	/	/	/	/	/	/	/	/
30	2017506	P. BARATH KALYAN	SFE	/	/	/	/	/	/	/	/	/	/	/	/
31	2017005	PRADHAP K	SFE	/	/	/	/	/	/	/	/	/	/	/	/
TOTAL				31	31	31	31			31	31	31	31		
PRESENT				31	31	30	30			31	31	31	31		
ABSENT				00	00	01	01			00	00	00	00		
PLACEMENT CO ORDINATOR SIGN				(S)	(S)	(S)	(S)	IV	IV	(S)	(S)	(S)	(S)		
HOD SIGN				<i>[Signature]</i>	<i>[Signature]</i>	<i>[Signature]</i>	<i>[Signature]</i>			<i>[Signature]</i>	<i>[Signature]</i>	<i>[Signature]</i>	<i>[Signature]</i>		
TRAINING OFFICER				<i>[Signature]</i>	<i>[Signature]</i>	<i>[Signature]</i>	<i>[Signature]</i>			<i>[Signature]</i>	<i>[Signature]</i>	<i>[Signature]</i>	<i>[Signature]</i>		
PRINCIPAL				<i>[Signature]</i>	<i>[Signature]</i>	<i>[Signature]</i>	<i>[Signature]</i>			<i>[Signature]</i>	<i>[Signature]</i>	<i>[Signature]</i>	<i>[Signature]</i>		



[Signature]
 PRINCIPAL
 K.S.R. COLLEGE OF ENGINEERING
 K.S.R. KALVI NAGAR,
 TIRUCHENGODE-637 215

KSR College of Engineering (Autonomous), Tiruchengode – 637 215

Training and Placement Cell

Phase – 1 Aptitude, Soft skill and Technical Training Schedule for 2023 Batch

FN	AN
Achievers Tech Talks	Interaction
Resume Building & Presentation	Essay writing & Group Discussion , Activity
SWOT Analysis & Self Introduction	Individual Activity
Permutation and Combination	Probability
Blood Relation, Syllogism	Directions, Coding and Decoding
JDK, JRE, JVM, Structure of Java class	Method overloading , Constructors
Datatypes & Operators, Identifiers	Inheritance , Polymorphism
Polymorphism	Wrapper Class
Exception Handling	String & String Builder

FN Session

9.30 am to 12.30 pm

AN Session

01.30 pm to 04.00 pm

Assessment

04.30 pm to 06.00 pm

*10.46 am – 11.00am - Break

*12.30 pm – 01.30 pm -Lunch Break

* 02.46 pm – 03.00 pm – Break



PRINCIPAL
K.S.R. COLLEGE OF ENGINEERING
K.S.R. KALVI NAGAR,
TIRUCHENGODE-637 215

S. Gnanapriya
25- APR 22





K.S.R. COLLEGE OF ENGINEERING

KSRCE/QM/8.6/22/PDC

(Autonomous)

TIRUCHENGODE - 637 215. TAMILNADU, INDIA.

Approved by AICTE, New Delhi, Anna University, Chennai & Accredited by NBA and NAAC with 'A' Grade

Professionals Development Cell

Certificate of Participation

This is to certify that ~~Mr./Ms.~~..... PRIYANKA P.....
of..... INFORMATION TECHNOLOGY..... department has participated in the
..... APTITUDE AND SOFTSKILL TRAINING.....
programme held at..... TRAINING AND PLACEMENT CELL - KSRCE.....
on 25.4.22 - 30.4.22. We wish the student all success.

Date: 30.04.2022

S. Ananya
Organizer.

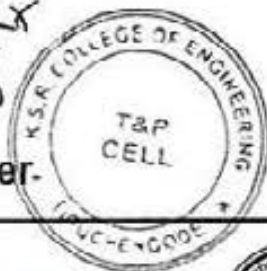

G. P. S.
Co-ordinator



[Signature]
Principal
K.S.R. COLLEGE OF ENGINEERING
K.S.R. KALVI NAGAR
TIRUCHENGODE-637 215



HIGHER EDUCATIONAL CELL





K.S.R. COLLEGE OF ENGINEERING

KSRCE/QM/8.6/22/PDC

(Autonomous)

TIRUCHENGODE 637 215.TAMILNADU, INDIA.

Approved by AICTE, New Delhi, Anna University, Chennai & Accredited by NBA and NAAC with 'A' Grade

Professionals Development Cell

Certificate of Participation

This is to certify that Mr./Ms. YUGESH . C.....
of CIVIL ENGINEERING.....department has participated in the
APTITUDE AND SOFTSKILL TRAINING.....
programme held at TRAINING AND PLACEMENT CELL - KSRCE.....
on 25.4.22 - 30.4.22 We wish the student all success.

Date: 30.4.2022

S. Manjyxx
Organizer

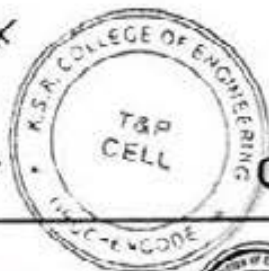

G. F. S.
Co-ordinator



[Signature]
Principal

PRINCIPAL,
K.S.R. COLLEGE OF ENGINEERING
K.S.R. KALVI NAGAR
TIRUCHENGODE-637 215



HIGHER EDUCATIONAL CELL





KSRCE/QM/8.6/22/PDC

K.S.R. COLLEGE OF ENGINEERING

(Autonomous)

TIRUCHENGODE - 637 215, TAMILNADU, INDIA.

Approved by AICTE, New Delhi, Anna University, Chennai & Accredited by NBA and NAAC with 'A' Grade

Professionals Development Cell

Certificate of Participation

This is to certify that Mr./Ms. SHANKAR S.
 of COMPUTER SCIENCE AND ENGINEERING department has participated in the
APTITUDE AND SOFT SKILL TRAINING
 programme held at TRAINING AND PLACEMENT CELL - KSRCE
 on 25.4.22 - 30.4.22. We wish the student all success.

Date: 30.04.2022

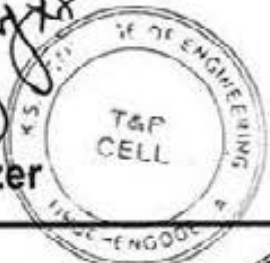

 Organizer

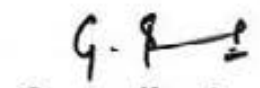

 Co-ordinator



 Principal

 PRINCIPAL
 K.S.R. COLLEGE OF ENGINEERING
 K.S.R. KALVI NAGAR,
 TIRUCHENGODE-637 215



HIGHER EDUCATIONAL CELL





KSRCE/QM/8.6/22/PDC

K.S.R. COLLEGE OF ENGINEERING

(Autonomous)

TIRUCHENGODE - 637 215. TAMILNADU, INDIA.

Approved by AICTE, New Delhi, Anna University, Chennai & Accredited by NBA and NAAC with 'A' Grade

Professionals Development Cell

Certificate of Participation

This is to certify that Mr./Ms. JAI SURYA, T
 of MECHANICAL ENGINEERING department has participated in the
APTITUDE AND SOFTSKILL TRAINING
 programme held at TRAINING AND PLACEMENT CELL - KSRCE
 on 25.4.22 - 30.4.22 We wish the student all success.

Date: 30.04.2022

S. Ganapathy
Organizer

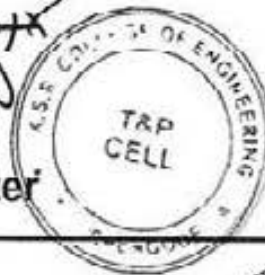

G. F. R.
Co-ordinator



[Signature]
Principal

PRINCIPAL
K.S.R. COLLEGE OF ENGINEERING
K.S.R. KALVI NARAYANAR,
TIRUCHENGODE - 637 215



HIGHER
EDUCATIONAL
CELL

